



water visions 04

CERAMICS FOR INNOVATIVE POOLS, WELLNESS AND SPAS



CASALGRANDE
PADANA
THE GREEN WAY TO PAVE

water visions 04

index

04 INTRO

PROGETTARE CON L'ACQUA

DESIGNING WITH WATER

CONCEPTS D'EAU

MIT WASSER GESTALTEN

08 **BiosCeramics - Antibacterial®** Ceramiche bioattive

BiosCeramics - Antibacterial®
Bioactive ceramics

BiosCeramics - Antibacterial®
Céramiques bioactives

BiosCeramics - Antibacterial®
Bioaktive Keramik

12 **Soluzioni personalizzate e assistenza tecnica**

CUSTOM SOLUTIONS AND TECHNICAL SUPPORT

SOLUTIONS PERSONNALISEES ET ASSISTANCE TECHNIQUE

INDIVIDUELLE LÖSUNGEN UND TECHNISCHE

UNTERSTÜTZUNG

14 **Sicurezza** e norme antiscivolo

SAFETY AND NON-SLIP STANDARDS

SÉCURITÉ ET NORMES ANTIDERAPANTES

SICHERHEIT UND RUTSCHHEMMUNGSNORMEN

16 **Percorsi per le disabilità visive**

PATHS FOR VISUALLY DISABLED PEOPLE

PARCOURS POUR MALVOYANTS ET AVEUGLES

LEITWEGE FÜR SEHBEHINDERTE

18 SPORT&FUN

PIASTRELLE E PEZZI SPECIALI SPECIFICI PER PISCINE E IMPIANTI NATATORI

CERAMIC TILES AND FITTINGS FOR SWIMMING POOLS AND
AQUATIC CENTERS

CARREAUX ET PIÈCES SPECIALES POUR PISCINES ET
CENTRES AQUATIQUES

FLIESEN UND FORMSTÜCKE FÜR SCHWIMMBÄDERN
UND SCHWIMMANLAGEN

20 **Landscape** GRESPLUS

piastrelle in gres porcellanato smaltato

GLAZED PORCELAIN TILES

CARREAUX EN GRES CERAME EMAILLE

GLASIERTE FEINSTEINZEUG-FLIESEN

22 **superfici** / surfaces / surface / oberflächen

24 **colori** / colours / couleurs / farben

26 **mosaici** / mosaics / mosaïque / mosaik

28 **Elementi**_GRANITOGRES

piastrelle in gres porcellanato non smaltato

UNGLAZED PORCELAIN TILES

CARREAUX EN GRES CERAME NON EMAILLE

UNGLASIERTE FEINSTEINZEUG-FLIESEN

30 **superfici** / surfaces / surface / oberflächen

32 **colori** / colours / couleurs / farben

34 **Padana Trim**

pezzi speciali e sistema Trim-Box

TRADITIONAL FITTINGS AND TRIM-BOX SYSTEM

PIÈCES SPECIALES ET SYSTEME TRIM-BOX

TRADITIONELLE FORMSTÜCKE UND DAS SYSTEM TRIM-BOX

52 **Padana Grid**

griglie e accessori

GRATINGS AND ACCESSORIES

GRILLES ET ACCESSOIRES

ROSTE UND ZUBEHÖR

60 **Padana Deck**_Sport&Fun

canalette per esterni vasca

CHANNELS FOR POOL DECKS

CANIVEAUX DE PLAGE

BECKENUMGANGSRINNEN

66 **Finishing Systems**

bordi vasca e altri elementi costruttivi

POOL BORDERS AND OTHER POOL ELEMENTS

TÊTES DE BASSIN ET AUTRES ÉLÉMENTS DE PISCINE

BECKENKÖPFE UND ANDERE BAUELEMENTE

102 WELLNESS&SPA

CERAMICHE PER WELLNESS E SPA

CERAMICS FOR WELLNESS AND SPA

CERAMIQUES POUR WELLNESS ET SPA

KERAMIK FÜR WELLNESS UND SPA

104 **Naturali come l'acqua**

AS NATURAL AS WATER

NATURELLES COMME L'EAU

NATÜRLICH WIE DAS WASSER

106 **Mineral Chrom_PIETRE NATIVE**

108 **colori** / colours / couleurs / farben

110 **decori** / decors / decorations / dekore

112 **pezzi speciali** / fittings / pièces spéciales / formstücke

118 **bordi vasca e altri elementi costruttivi**

pool borders and other pool elements

têtes de bassin et autres éléments de piscine

Beckenköpfe und andere Bauelemente

130 **Amazonia_PIETRE NATIVE**

132 **colori** / colours / couleurs / farben

134 **decori** / decors / decoration / dekore

136 **pezzi speciali** / fittings / pièces spéciales / formstücke

142 **bordi vasca e altri elementi costruttivi**

pool borders and other pool elements

têtes de bassin et autres éléments de piscine

Beckenköpfe und andere Bauelemente

156 **Country Wood_GRANITOKER**

158 **Marte_GRANITOGRES**

164 **Pietre di Sardegna_PIETRE NATIVE**

168 **Pietra Baugé_PIETRE NATIVE**

170 **Stile_PIETRE NATIVE**

174 **Timeless_GRANITOGRES**

176 **Petra_PIETRE NATIVE**

182 **Eco Concrete_GRESPLUS**

184 **Padana Deck_Wellness&Spa**

canalette per esterni vasca

CHANNELS FOR POOL DECKS

CANIVEAUX DE PLAGE

BECKENUMGANGSRINNEN

192 COMPLEMENTARY PRODUCTS

PRODOTTI COMPLEMENTARI

PRODUITS COMPLEMENTAIRES

ERGÄNZUNGSPRODUKTE

202 TECH INFO

CARATTERISTICHE TECNICHE

TECHNICAL FEATURES

CARACTERISTIQUES TECHNIQUES

TECHNISCHE EIGENSCHAFTEN

210 **Mosaici**

MOSAICS

MOSAÏQUE

MOSAIKEN

211 **Manutenzione e pulizia** **Maintenance and cleaning** **Entretien et nettoyage** **Instandhaltung und reinigung**



INTRO

PROGETTARE CON L'ACQUA

DESIGNING WITH WATER

CONCEPTS D'EAU

MIT WASSER GESTALTEN

Progettare con l'acqua

DESIGNING WITH WATER
CONCEPTS D'EAU
MIT WASSER GESTALTEN

Fare piscine e farle bene è la mission di Casalgrande Padana. I grandi impianti natatori, i centri termali, i parchi acquatici ed anche le piscine private hanno sempre maggiore diffusione e sono diventati non solo importanti realizzazioni architettoniche ma anche luoghi sociali sempre da vivere pienamente.

La ricerca sui materiali, l'analisi delle criticità legate al progetto e l'applicazione di soluzioni tecniche evolute sono il nucleo delle attività del team di tecnici di Casalgrande Padana che unisce capacità ingegneristiche ad una lunga esperienza concreta e diretta sul campo.

La prima parte del catalogo illustra i prodotti specificatamente studiati e sviluppati per gli impianti natatori sportivi mentre la seconda parte comprende una selezione di prodotti della gamma Casalgrande Padana dalla particolare ricercatezza estetica e materica rielaborati e corredati per l'impiego in piscine, aree wellness e spa.

Producing quality swimming pools is the mission of Casalgrande Padana. Large swimming facilities, spas and thermal baths, water parks and even private pools are becoming increasingly popular and have turned into remarkable architectural feats, but also into fully exploited and frequented social venues.

Material research, project analysis and the use of evolved technical solutions are at the core of the work of the Casalgrande Padana's design team, who combine engineering expertise with a long and direct field experience.

The first part of the catalogue describes those products specifically designed and developed for competition pools, while the second section delves into a selection of products of the Casalgrande Padana range that stand out for the remarkable aesthetic value, conceived and provided for use in pools, wellness centres and spas.

La mission de Casalgrande Padana est la conception de piscines de qualité. Les grands centres nautiques, les stations thermales, les parcs aquatiques et les piscines privées sont de plus en plus répandus, s'étant transformés en lieux de socialisation, en plus d'être des œuvres architecturales importantes.

La recherche sur les matières, l'analyse des points critiques liés aux projets et l'application de solutions techniques évoluées sont les activités principales de l'équipe technique de Casalgrande Padana, qui associe compétences de génie civil et une longue expérience sur le terrain.

La première partie de ce catalogue décrit les produits spécialement conçus et développés pour les centres nautiques, tandis que la deuxième inclut un éventail de produits de la gamme Casalgrande Padana, de très haute qualité esthétique et matérielle, revisités et assortis pour leur emploi dans les piscines des centres de bien-être et des spas.

Schwimmbäder zu konstruieren und zwar gut, das ist die Mission von Casalgrande Padana. Große Schwimmanlagen, Kurmittelhäuser, Wasserparks sowie Privatschwimmbäder sind immer stärker verbreitet und haben nicht nur als bedeutende architektonische Bauten sondern auch als vollwertige soziale Orte eine hohe Wertigkeit erlangt.

Die Materialforschung, die Analyse der kritischen Punkte des Projektes sowie die Anwendung fortschrittlicher technischer Lösungen bilden den Tätigkeitsschwerpunkt des technischen Teams von Casalgrande Padana, das ingenieurtechnische Fähigkeiten und eine langjährige konkrete Erfahrung direkt vor Ort miteinander in Einklang bringt.

Der erste Teil des Katalogs illustriert die Produkte, die spezifisch für die Wassersportanlagen erforscht und entwickelt wurden, während der zweite Teil eine Auswahl von Produkten mit besonders hochwertigen ästhetischen und materiellen Eigenschaften des Sortiments Casalgrande Padana enthält, die überarbeitet und für die Verwendung in Schwimmbäder, Wellnesszentren und Heilbädern ausgelegt wurden.



bios antibacterial®

BIOS CERAMICS®

Bios Ceramics® è la più avanzata ed esclusiva generazione di ceramiche bioattive per applicazioni architettoniche, certificate ed ecocompatibili, con caratteristiche antibatteriche, autopulenti e di riduzione degli agenti inquinanti.

La produzione si articola nell'ambito di due trattamenti estremamente specializzati e continuamente soggetti a migliorie prestazionali, **Bios Self-Cleaning®** e **Bios Antibacterial®**, in grado di rispondere a qualsiasi esigenza applicativa in interni ed esterni, in funzione delle specifiche condizioni di impiego.

Una proposta trasversale e diversificata che in oltre vent'anni di sperimentazione ha permesso di soddisfare la creatività di progettisti e clienti in tutto il mondo, grazie alle ricercate finiture e ai diversi formati disponibili su tutta la gamma prodotti di Casalgrande Padana.

BIOS SELF-CLEANING®

Il trattamento **Bios Self-Cleaning®** è impiegato nella realizzazione di rivestimenti esterni di facciata e involucri ventilati.

Grazie alla speciale **tecnologia Hydrotect®**, in presenza di luce solare **Bios Self-Cleaning®** attiva una reazione in grado di abbattere non solo i batteri, ma soprattutto gli inquinanti

presenti nell'aria e decomporre lo sporco che si deposita sulla superficie delle piastrelle, in modo che possa essere rimosso dallo scorrere dell'acqua piovana, grazie alla superidrofilia della superficie ceramica.

BIOS ANTIBACTERIAL®

Il trattamento **Bios Antibacterial®** è in grado di conferire proprietà antibatteriche alla superficie ceramica, grazie ad una tecnologia agli ioni d'argento che blocca il metabolismo dei batteri.

LA FUNZIONE ANTIBATTERICA

Contrariamente ai disinfettanti comuni, un battericida come **Bios Antibacterial®** è in grado di assicurare una protezione costante contro i microrganismi, combattendo i microbi in tre modi: interrompe il metabolismo cellulare, blocca i processi di trasporto nella membrana e impedisce la moltiplicazione delle celle.

Dopo severe prove di laboratorio, il trattamento è risultato capace di abbattere al 99% i quattro principali ceppi batterici responsabili delle infezioni che si registrano in ambito ospedaliero e che sono stati adottati come standard perché rappresentano la categoria più aggressiva, in alcuni casi anche resistente agli antibiotici: *Staphylococcus aureus*, *Enterococcus faecalis*, *Escherichia coli*, *Pseudomonas aeruginosa*.

SEMPRE ATTIVO

Il trattamento antibatterico è incorporato in modo permanente nel prodotto ceramico ed è sempre attivo, giorno e notte, con o senza luce solare, e non necessita di raggi UV per l'attivazione.

ANTI-ODORE E ANTI-MUFFA

Oltre al potere battericida, **Bios Antibacterial®** evita la formazione di muffe, lieviti e funghi, principali responsabili dei cattivi odori, rendendo gli ambienti più sani e gradevoli all'olfatto.

FACILE DA PULIRE E INALTERABILE

Grazie alla loro impermeabilità naturale e all'assenza di porosità, le superfici ceramiche vantano una velocità e facilità di pulizia superiore rispetto ad altri materiali. Inoltre, essendo il trattamento integrato in modo permanente, l'usura del pavimento non modifica le prestazioni antibatteriche della piastrella.

CONFORMITÀ BPR

La commercializzazione di **Bios Antibacterial®** è autorizzata e approvata dal Regolamento Europeo sui Biocidi (EU BPR 528/2012).



GUARDA IL VIDEO
(Bios Antibacterial®)



GUARDA IL VIDEO
(Bios Self-Cleaning®)

Ulteriori dettagli su www.biosceramics.it

bios.
ceramics

bios antibacterial®

BIOS CERAMICS®

Bios Ceramics® is the most advanced, exclusive generation of bioactive ceramics for certified, eco-compatible architectural applications, with antibacterial and self-cleaning properties and the ability to reduce pollutants.

The production is divided into two highly specialized treatments with continually improving performance:

Bios Self-Cleaning® and **Bios Antibacterial®**, able to respond to all kinds of requirements for applications indoors and outdoors, depending on the specific conditions of use.

In over 20 years of experimentation, this diversified offer, available across a variety of products, has made it possible to meet the creative requirements of designers and customers all over the world, thanks to the sophisticated finishes and the different formats available throughout the entire Casalgrande Padana product range.

BIOS SELF-CLEANING®

The **Bios Self-Cleaning®** treatment has been used for ventilated façades and cladding for over 14 years. Thanks to the special **Hydrotect® technology**, when the **Bios Self-Cleaning®** treatment comes into contact with sunlight, it triggers a reaction able to eliminate not only bacteria, but especially the pollutants in the air. It breaks

down dirt that has settled on the surface of the tiles, so that it can be removed by rainwater, thanks to the superhydrophilicity of the ceramic material.

BIOS ANTIBACTERIAL®

The **Bios Antibacterial®** treatment is able to give the ceramic surface antibacterial properties, using a silver ion technology that blocks the metabolism of bacteria.

The antibacterial feature Unlike the most common disinfectants, a bactericidal product such as **Bios Antibacterial®** is able to guarantee continual protection against these micro-organisms in three ways: it interrupts cell metabolism, blocks the processes of transport into the membrane and prevents the multiplication of the cells.

Following strict laboratory tests, **Bios Antibacterial®** proved capable of eliminating 99% of the four main strains of bacteria that are responsible for infections in hospital environments and have been adopted as the standard because they represent the most aggressive category, in some cases even resistant to antibiotics: *Staphylococcus aureus*, *Enterococcus faecalis*, *Escherichia coli* and *Pseudomonas aeruginosa*.

ALWAYS ACTIVE

The antibacterial treatment is

permanently integrated into the ceramic product and is always active, day and night, with or without sunlight, and does not require UV rays for activation.

ANTI-ODOUR AND ANTI-MOULD

In addition to its bactericidal capacity, **Bios Antibacterial®** prevents the formation of mould, yeast and fungi, the main culprits of unpleasant odours, thus making settings healthier and with a more pleasant smell.

EASY TO CLEAN AND UNALTERABLE

Because they are naturally impermeable and non-porous, ceramic surfaces are quicker and easier to clean than other materials. Furthermore, because the antibacterial treatment is permanently integrated into the ceramic product, the wear and tear of the flooring has no impact on the antibacterial performance of the tile.

BPR COMPLIANT

Bios Antibacterial® is authorized for sale and approved by the European Biocidal Products Regulation (EU BPR 528/2012).



WATCH THE VIDEO
(Bios Antibacterial®)



WATCH THE VIDEO
(Bios Self-Cleaning®)

Further details at www.biosceramics.com

bios.
ceramics

bios antibacterial®

BIOS CERAMICS®

Bios Ceramics® est la génération la plus avancée et la plus exclusive de céramiques bioactives pour des applications architecturales, certifiées et écocompatibles, offrant des caractéristiques antibactériennes, autonettoyantes et de réduction des agents polluants.

La production s'articule autour de deux traitements extrêmement spécialisés et soumis en permanence à des améliorations en termes de performances, **Bios Self-Cleaning®** et **Bios Antibacterial®**, capables de répondre à toute exigence d'application à l'intérieur comme à l'extérieur, en fonction des conditions d'utilisation spécifiques.

Il s'agit d'une proposition transversale et diversifiée qui, au cours de plus de vingt années d'expérimentations, a permis de satisfaire la créativité des concepteurs et des clients dans le monde entier. Et ce, grâce aux finitions raffinées et aux différents formats disponibles sur toute la gamme des produits de Casalgrande Padana.

BIOS SELF-CLEANING®

Depuis plus de 14 ans, le traitement **Bios Self-Cleaning®** est utilisé pour réaliser des revêtements de façade ainsi que des enveloppes ventilées. Grâce à la **technologie** spéciale

Hydrotect®, Bios Self-Cleaning®

déclenche, en présence de rayonnement solaire, une réaction capable d'éliminer non seulement les bactéries mais aussi et surtout les polluants présents dans l'air, de décomposer les saletés qui se déposent sur la surface des dalles et de les éliminer grâce à l'eau de pluie et aux propriétés superhydrophiles de la surface céramique.

BIOS ANTIBACTERIAL®

Le traitement **Bios Antibacterial®** est en mesure de donner des propriétés antibactériennes à la surface céramique, grâce à une technologie aux ions d'argent qui inhibe le métabolisme des bactéries.

LA FONCTION ANTIBACTÉRIENNE

Contrairement aux désinfectants couramment utilisés, un bactéricide comme **Bios Antibacterial®** est capable d'assurer une protection permanente contre les microorganismes en luttant contre les microbes des trois façons suivantes : il interrompt le métabolisme cellulaire, inhibe les processus de transport membranaire et empêche la multiplication des cellules.

À la suite de tests rigoureux menés en laboratoire, **Bios Antibacterial®** s'est révélé capable d'éliminer à 99% les quatre principales souches

bactériennes responsables des infections enregistrées en milieu hospitalier. Elles ont été adoptées comme référence car elles représentent la catégorie la plus agressive, et, dans certains cas, elles résistent également aux antibiotiques : *Staphylococcus aureus*, *Enterococcus faecalis*, *Escherichia coli* et *Pseudomonas aeruginosa*.

TOUJOURS ACTIF

Le traitement antibactérien est intégré de façon permanente dans le produit céramique et il est toujours actif, jour et nuit, avec ou sans rayonnement solaire, et, pour son activation, les rayons UV ne sont pas nécessaires.

ANTI-ODEURS ET ANTI-MOISSURE

En plus de son pouvoir bactéricide, **Bios Antibacterial®** évite l'apparition de moisissures, de levures et de champignons, principaux responsables des mauvaises odeurs, ce qui permet de rendre les espaces plus sains et plus agréables à l'odorat.

FACILE À NETTOYER ET INALTÉRABLE

Grâce à leur imperméabilité naturelle et à l'absence de porosité, les surfaces céramiques sont plus faciles et plus rapides à nettoyer que les autres matériaux. En plus, le traitement antibactérien étant intégré de façon permanente dans le produit céramique, l'usure du sol ne

modifie pas les prestations antibactériennes de la dalle.

CONFORMITÉ BPR

La commercialisation de **Bios Antibacterial®** est autorisée et approuvée par le Règlement européen sur les produits biocides (UE BPR 528/2012).



REGARDEZ LA VIDÉO
(Bios Antibacterial®)



REGARDEZ LA VIDÉO
(Bios Self-Cleaning®)

De plus amples détails sur le site www.biosceramics.com

bios.
ceramics

bios antibacterial®

BIOS CERAMICS®

Bios Ceramics® ist die modernste und exklusivste Generation bioaktiver Keramik für architektonische Anwendungen. Sie ist zertifiziert und umweltfreundlich und besitzt antibakterielle, selbstreinigende und schadstoffreduzierende Eigenschaften.

Die Produktreihe gliedert sich in zwei äußerst spezifische Behandlungen, die einer ständigen Leistungsverbesserung unterliegen: **Bios Self-Cleaning®** und **Bios Antibacterial®**, mit denen entsprechend den jeweiligen Einsatzbedingungen alle erforderlichen Anwendungen im Innen- und Außenbereich erfüllt werden können.

Dank der hochwertigen Oberflächenausführungen und der verschiedenen Größen, die für die gesamte Produktpalette von Casalgrande Padana zur Verfügung stehen, ist es in mehr als zwanzig Jahren des Experimentierens gelungen, mit dieser transversalen und vielfältigen Angebotspalette die Kreativität von Designern und Kunden auf der ganzen Welt zu befriedigen.

BIOS SELF-CLEANING®

Die **Behandlung Bios Self-Cleaning®** wird seit über 14 Jahren bei der Konstruktion von Außenfassadenverkleidungen und hinterlüfteten Gebäudehüllen eingesetzt. Dank der speziellen

Hydrotect®-Technologie

bindet **Bios Self-Cleaning®** bei Sonneneinstrahlung nicht nur Bakterien, sondern vor allem die in der Luft vorhandenen Schadstoffe, und zersetzt den auf der Fliesenoberfläche abgelagerten Schmutz. Die extrem hydrophile Keramikoberfläche sorgt dafür, dass der Schmutz durch das abfließende Regenwasser entfernt wird.

BIOS ANTIBACTERIAL®

Die Behandlung **Bios Antibacterial®** kann die antibakterielle Eigenschaften verleihen in das Keramikprodukt, wegen der Silberionentechnologie, die den Stoffwechsel von Bakterien blockiert.

DIE ANTIBAKTERIELLE WIRKUNG

Im Gegensatz zu herkömmlichen Desinfektionsmitteln ist ein Bakterizid wie **Bios Antibacterial®** in der Lage, einen kontinuierlichen Schutz vor Mikroorganismen zu bieten, indem es die Mikroben auf dreifache Weise bekämpft: Es unterbricht den Zellstoffwechsel, blockiert Transportprozesse in der Membran und verhindert die Zellvermehrung.

Im Rahmen strenger Labortests hat sich gezeigt, dass **Bios Antibacterial®** zu 99 % die vier wichtigsten Bakterienstämme abtöten kann,

die für Krankenhausinfektionen verantwortlich sind.

Diese Stämme wurden als Standard übernommen, da sie die aggressivste Kategorie darstellen und in einigen Fällen sogar resistent gegen Antibiotika sind: Staphylococcus aureus, Enterococcus faecalis, Escherichia coli und Pseudomonas aeruginosa.

IMMER AKTIV

Die antibakterielle Beschichtung ist dauerhaft in das Keramikprodukt integriert und immer aktiv, Tag und Nacht, mit oder ohne Sonnenlicht, und benötigt keine UV-Strahlen zur Aktivierung.

GERUCHSHEMMEND UND SCHIMMELHEMMEND

Zusätzlich zu seiner bakteriziden Wirkung verhindert **Bios Antibacterial®** die Bildung von Schimmel, Hefen und Pilzen, den Hauptverursachern schlechter Gerüche, und macht die Umgebung gesünder und angenehmer im Geruch.

LEICHT ZU REINIGEN UND UNVERÄNDERLICH

Dank ihrer natürlichen Undurchlässigkeit und Porenfreiheit lassen sich Keramikoberflächen schneller und einfacher reinigen als andere Materialien. Darüber hinaus da die antibakterielle Beschichtung dauerhaft in das Keramikprodukt integriert ist, ändert der Bodenverschleiß

die antibakterielle Wirkung der Fliese nicht.

BPR-KONFORMITÄT

Die Vermarktung von **Bios Antibacterial®** ist durch die europäische Biozid-Verordnung (EU BPR 528/2012) zugelassen und genehmigt.



DAS VIDEO ANSEHEN
(Bios Antibacterial®)



DAS VIDEO ANSEHEN
(Bios Self-Cleaning®)

Weiter Details auf der Website www.biosceramics.com

bios.
ceramics

Soluzioni personalizzate e assistenza tecnica

CUSTOM SOLUTIONS AND TECHNICAL SUPPORT
SOLUTIONS PERSONNALISEES ET ASSISTANCE TECHNIQUE
INDIVIDUELLE LÖSUNGEN UND TECHNISCHE UNTERSTÜTZUNG

La divisione Swimming Pool di Casalgrande Padana, oltre a proporre tecnologie e materiali ad alte prestazioni, è in grado di fornire alla propria clientela un servizio efficace ed efficiente per offrire al progettista una attiva assistenza per lo studio e lo sviluppo del progetto nelle sue varie fasi e gli strumenti per creare soluzioni personalizzate.

Una collaborazione che aiuta nell'orientamento tra i sistemi di finitura e nella valutazione dei prodotti Casalgrande Padana più idonei alle specifiche funzioni.

Besides providing high-performance technology and materials, Casalgrande Padana's Swimming Pool division provides customers with effective and efficient services in order to give designers active assistance during the project design and development phases as well as the tools to create custom solutions.

This collaboration helps moving among finishing systems and selecting the most suitable products in the Casalgrande Padana range.

En plus de proposer des technologies et des matières haut de gamme, la division Swimming Pool de Casalgrande Padana fournit à ses clients des services efficaces et efficaces pour offrir aux architectes une assistance active lors de l'étude, à la conception du projet dans ses différentes phases et de la création de solutions personnalisées.

Une collaboration efficace qui aide à s'orienter parmi les systèmes de finition et l'évaluation des produits Casalgrande Padana les plus adéquats pour des fonctions spécifiques.

Die Abteilung Swimming Pool von Casalgrande Padana bietet ihrer Kundschaft nicht nur hochwertige Technologien und Materialien, sondern auch einen wirksamen und effizienten Kundenservice, um dem Planer eine aktive Unterstützung beim Entwurf und bei der Entwicklung des Projektes in seinen verschiedenen Phasen zu leisten und ihm die Mittel zur Schaffung individueller Lösungen zur Verfügung zu stellen.

Diese Zusammenarbeit hilft bei der Orientierung zwischen den Ausführungssystemen und bei der Identifizierung der Produkte von Casalgrande Padana, die für die spezifischen Funktionen am besten geeignet sind.

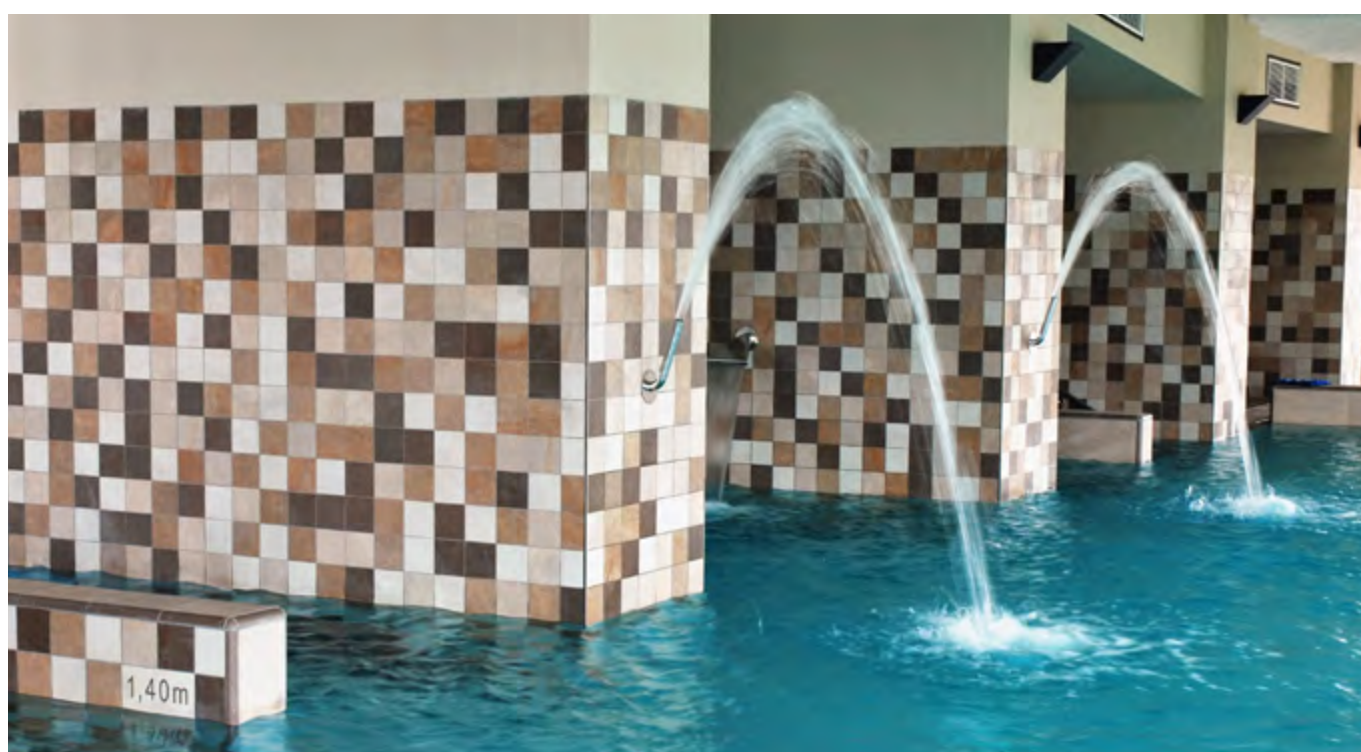

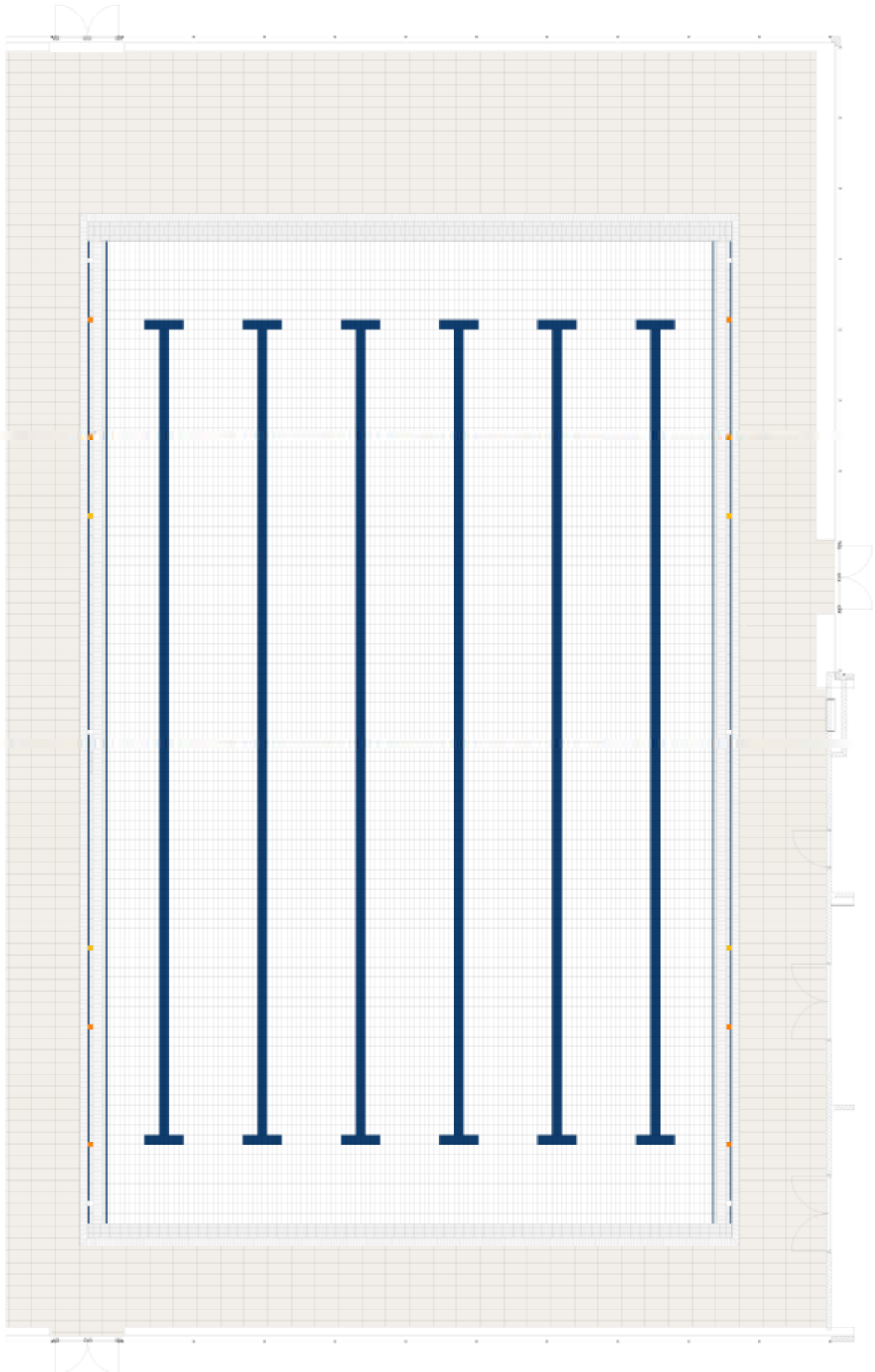

Sicurezza e norme antiscivolo

SAFETY AND NON-SLIP STANDARDS
SECURITE ET NORMES ANTIDERAPANTES
SICHERHEIT UND RUTSCHHEMMUNGSNORMEN

La presenza di superfici asciutte, bagnate o addirittura completamente immerse nell'acqua rende indispensabile l'utilizzo di materiali con specifiche caratteristiche antiscivolo. Tutte le gamme di prodotti illustrate in questo catalogo includono diverse tipologie di superfici in modo da poter essere impiegate nei diversi ambienti per evitare qualsiasi rischio di caduta.

Le piastrelle in gres porcellanato, sia nella versione smaltata che non smaltata, diventano quindi materiali affidabili sotto il profilo della sicurezza antiscivolo e pratiche sotto l'aspetto della facilità di pulizia e dell'igiene.

Le normative più idonee a valutare la resistenza alla scivolosità a piedi nudi sono la norma tedesca DIN 51097 e quella francese più recente XP P 05-010. Entrambe le norme prevedono una classificazione dei vari tipi di locali ai quali attribuiscono i necessari valori antiscivolo.

Nel caso di aree e superfici generalmente bagnate è importante anche poter valutare la capacità drenante dei pavimenti per evitare inutili ristagni d'acqua e prevenire fenomeni di aquaplaning. La norma DIN 51130 e in grado di determinare, oltre alla valutazione della scivolosità a piedi calzati, anche il coefficiente di drenaggio "V" delle superfici ceramiche.

The presence of dry, wet or even completely submerged surfaces makes it essential to use specifically anti-slip materials. All product ranges described in this section include different types of surfaces, for use in different contexts to prevent any risk of falling.

Porcelain tiles, either in the glazed or unglazed version, stand as reliable materials material in terms of slip resistance and ease of maintenance and cleaning.

The most appropriate standards to assess barefoot anti-slip performance are German DIN 51097 and the latest French XP P 05-010.

Both standards provide a classification of different types of premises, to which they attribute the relevant non-slip performance values.

For generally wet areas it is also important to assess drainage capacity in order to prevent unnecessary accumulations of water and prevent aquaplaning. In this respect, the standard DIN 51130 can also measure the "V" drainage coefficient of ceramic surfaces.

La présence de surfaces sèches, humides ou même totalement plongées dans l'eau rend indispensable l'emploi de matériaux avec des caractéristiques antidérapantes spécifiques. Toutes les gammes des produits décrites dans ce catalogue comprennent de différentes typologies de surfaces, en mesure d'être utilisées dans plusieurs contextes pour éviter les risques de chute.

Les carreaux en grès cérame, dans leur version émaillée ou non, s'avèrent alors des matériaux fiables sur le plan de la résistance antidérapante et pratiques en ce qui concerne l'entretien et le nettoyage.

Les normes les plus adéquates pour évaluer la résistance à la glissance mesurée pieds nus sont la norme allemande DIN 51097 et celle française XP P 05 010, plus récente.

Les deux normes prévoient une classification des différents types de locaux auxquels sont attribuées les valeurs antidérapantes nécessaires.







En cas de zones et surfaces généralement humides, il faut également évaluer la capacité de drainage des revêtements de sol pour éviter des accumulations d'eau inutiles et prévenir les phénomènes d'aquaplaning. A cet égard, la norme DIN 51130 peut mesurer non seulement l'évaluation de la glissance pieds chaussés mais aussi le coefficient de drainage "V" des surfaces céramiques.











Das Vorhandensein trockener, feuchter oder auch vollkommen mit Wasser bedeckter Oberflächen macht eine Verwendung von Materialien mit spezifischen rutschfesten Eigenschaften unerlässlich. Alle in diesem Katalog illustrierten Produktsortimente beinhalten verschiedene Oberflächenausführungen zur Verwendung in den unterschiedlichen Umgebungen, um ein jegliches Fallrisiko zu vermeiden.





Die Feinsteinzeugfliesen werden somit sowohl in glasierter als auch in unglasierter Version zu einem in Bezug auf die Rutschsicherheit zuverlässigen und hinsichtlich einer einfachen Reinigung und Hygiene praktischen Material.

Die Richtlinien, die sich zur Bestimmung der Rutschfestigkeit bei Betreten mit bloßen Füßen am besten eignen, sind die deutsche Norm DIN 51097 und die aktuellere französische Norm XP P 05-010.

Beide Normen sehen außerdem eine Klassifizierung der verschiedenen Räumlichkeiten vor, denen die jeweils erforderlichen Rutschsicherheitswerte zugeordnet werden. Im Fall von üblicherweise feuchten Oberflächen, muss auch die Sicherleistung der Böden bewertet werden können, um unnütze Wasseranstauungen oder Aquaplaning-Phänomene zu vermeiden. Die Norm DIN 51130 ist in der Lage nebst der Bewertung der Rutschsicherheit beim Begehen mit Schuhwerk auch den Dränkoeffizienten "V" der Keramikoberflächen zu bestimmen.

XP P 05-011		DIN 51097				
Valore piedi nudi Barefoot value Valeur pieds nus Barfußwert	Zone d'impiego Deployment areas Classement locaux Einsatzbereiche	Valore piedi nudi Barefoot value Valeur pieds nus Barfußwert	Zone d'impiego Deployment areas Classement locaux Einsatzbereiche			
PN 12 $12^\circ \leq \alpha < 18^\circ$ 	4.2.5 Piscine Vestiaires (zones sèches) Couloirs, escaliers (zones sèches) WC (zone sèches) 4.2.6 Thermalisme Sauna Salle de massage	A $\geq 12^\circ$ 	Corridoi percorribili a piedi nudi (prevalentemente asciutti)	Barefoot passages (nearly dry)	Couloirs à fréquentation pieds nus (souvent secs)	Barfußgänge (weitgehend trocken)
			Spogliatoi singoli e collettivi	Individual and common dressing rooms	Vestiaires individuels et collectifs	Einzel- und Sammelumkleideräume
			Fondo vasca nei settori per non nuotatori (se la profondità dell'acqua nell'intero settore misura più di 80 cm)	Pool floors in non-swimmer areas if the water depth is more than 80 cm in the entire area	Fonds de bassin pour non-nageurs si la profondeur d'eau n'est jamais inférieure à 80 cm.	Beckenböden in Nichtschwimmerbereichen, wenn im gesamten Bereich die Wassertiefe mehr als 80 cm beträgt
			Zone sauna e di riposo (prevalentemente asciutte)	Sauna and relaxation areas (nearly dry)	Les saunas et zones de repos (souvent secs)	Sauna- und Ruhebereiche (weitgehend trocken)
PN 18 $18^\circ \leq \alpha < 24^\circ$ 	4.2.5 Piscine Pataugeoires ou sol de bassin non nageur de profondeur inférieure à 80 cm Sol de bassin nageur de profondeur inférieure à 150 cm Plages (pente maxi de 5%) Gradins Locaux attenants aux plages Couloirs, escaliers (zones humides) Douches Vestiaires (zones humides) WC (zones humides) 4.2.6 Thermalisme Hammam, bain turc Local d'application de boues, d'algues Local de douches à jets Local de jets filaires Vaporarium Local de balnéothérapie	B $\geq 18^\circ$ 	Corridoi percorribili a piedi nudi, se non classificati nel gruppo A	Barefoot passages, if not classified in group A	Couloirs à fréquentation pieds nus autres que groupe A	Barfußgänge, soweit sie nicht A zugeordnet sind
			Docce	Showers	Salles de douches	Duschräume
			Area getti di disinfezione	Area of disinfecting spray facilities	Voisinage des pulvérisateurs de désinfectant	Bereich von Desinfektionssprühanlagen
			Aree circostanti la vasca	Pool surrounds	Plages de bassins	Beckenumgänge
			Fondo vasca nei settori per non nuotatori se la profondità dell'acqua è inferiore in alcuni punti a 80 cm	Pool floors in non-swimmer areas if the water depth is less than 80 cm in certain areas	Fonds de bassins pour non-nageurs quand la profondeur peut être inférieure à 80 cm	Beckenböden in Nichtschwimmerbereichen, wenn in Teilbereichen die Wassertiefe weniger als 80 cm beträgt
			Fondo vasca nei settori per non nuotatori in piscine con onde artificiali	Non-swimmer sections of wave-action pools	Fonds de bassins – zone « non-nageurs » – de piscines à vagues artificielles	Beckenböden in Nichtschwimmerbereichen von Wellenbecken
			Fondo vasca regolabile in altezza	Movable floors	Sols éleveurs	Hubböden
			Vasche per bambini	Paddling pools	Bassins d'enfants	Planschbecken
			Scale e gradini all'esterno della vasca	Ladders and stairs outside the pool area	Echelles et escaliers situés hors du voisinage du bassin	Leitern und Treppen außerhalb des Beckenbereiches
			Zone sauna e di riposo, se non classificate nel gruppo a	Sauna and relaxation areas, if not classified in group A	Saunas et zones de repos, sauf ceux affectés à la catégorie A	Sauna- und Ruhebereiche, soweit sie nicht A zugeordnet sind
PN 24 $\alpha \geq 24^\circ$ 	4.2.5 Piscine Pédiluves Margelles Plots Escaliers d'accès à l'eau Rampes d'accès à l'eau Bordures de bassin immergées Quais de départ	C $\geq 24^\circ$ 	Gradini e scale di entrata in acqua	Ladders and stairs leading into the water	Echelles et escaliers d'entrée dans l'eau	Ins Wasser führende Leitern und Treppen
			Salite a trampolini e acquascivoli	Stairs up to diving facilities and water slides	Echelles d'accès aux plongoirs et toboggans aquatiques	Aufgänge zu Sprunganlagen und Wasserrutschen
			Vasche lavapiedi	Walk-through pools	Pédiluves	Durchschreitebecken
			Bordovasca inclinato	Inclined pool edges	Bords de bassin inclinés	Geeigte Beckenrandausbildungen

XP P 05-010		DIN 51130	
Valore piedi calzati Shoed value Valeur pieds chaussés Bewertungsgruppen		Valore piedi calzati Shoed value Valeur pieds chaussés Bewertungsgruppen	
	PC6 $6^\circ \leq \alpha < 10^\circ$		R9 > 6° - 10°
	PC 10 $10^\circ \leq \alpha < 20^\circ$		R10 > 10° - 19°
	PC 20 $20^\circ \leq \alpha < 27^\circ$		R11 > 19° - 27°
	PC 27 $27^\circ \leq \alpha < 35^\circ$		R12 > 27° - 35°
	PC 35 $\alpha \geq 35^\circ$		R13 > 35°

DIN 51130	
Volumi di drenaggio Drainage volume Volume de drenage Verdrängungsraum	
	V4
4 cm³ / dm²	
	V6
6 cm³ / dm²	
	V8
8 cm³ / dm²	
	V10
10 cm³ / dm²	

Percorsi per le disabilità visive

PATHS FOR VISUALLY DISABLED PEOPLE
PARCOURS POUR MALVOYANTS ET AVEUGLES
LEITWEGE FÜR SEHBEHINDERTE

Casalgrande Padana, da sempre sensibile ai problemi sociali e delle disabilità, ha sviluppato e realizzato il progetto Granitogres Tactile, un vero e proprio insieme di codici a rilievo impressi direttamente sulle ceramiche in gres porcellanato che consente la realizzazione di percorsi tattili completi e capaci di offrire una maggiore autonomia negli spostamenti dei non vedenti e ipovedenti negli edifici pubblici e in ambito urbano in genere.

Per ulteriori dettagli vedi catalogo Tactile.

Casalgrande Padana has always been sensitive to social problems and disabilities. For this reason, it has developed and created the Granitogres Tactile project, a set of embossed codes printed directly on the porcelain tiles for the development of comprehensive tactile paths offering greater autonomy to the visually impaired and blind in public buildings and urban settings in general.

For further details see the Tactile catalogue.

Casalgrande Padana, toujours sensible aux problèmes sociaux et aux incapacités, a développé et créé le projet Granitogres Tactile, un véritable ensemble de codes en relief, imprimés directement sur les carreaux en grès cérame, pour la création de parcours tactiles complets, en mesure d'offrir une plus grande autonomie aux malvoyants et non-voyants dans les bâtiments publics et dans l'environnement urbain en général.

Pour plus détails voir catalogue Tactile.

Casalgrande Padana widmet seit jeher den sozialen Problemen und den Behinderungen eine besondere Aufmerksamkeit und hat nunmehr das Projekt Granitogres Tactile entwickelt und umgesetzt. Es handelt sich um einen direkt in das Feinsteinzeug eingepprägten Blinddruck, der die Verwirklichung von kompletten taktilen Leitwegen ermöglicht, die den Blinden und Sehbehinderten zu einer größeren Autonomie bei der Fortbewegung in den öffentlichen Gebäuden und im städtischen Milieu im Allgemeinen verhelfen können.

Für Details siehe Katalog Tactile.





SPORT & FUN

PIASTRELLE E PEZZI SPECIALI SPECIFICI PER PISCINE E IMPIANTI NATATORI

CERAMIC TILES AND FITTINGS
FOR SWIMMING POOLS AND AQUATIC CENTERS

CARREAUX ET PIECES SPECIALES
POUR PISCINES ET CENTRES AQUATIQUES

FLIESEN UND FORMSTÜCKE
FUER SCHWIMMBÄDERN UND SCHWIMMANLAGEN

Landscape

GRESPLUS

piastrelle in gres porcellanato smaltato

GLAZED PORCELAIN TILES
CARREAUX EN GRES CERAME EMAILLE
GLASIERTE FEINSTEINZEUGFLIESEN

La serie Landscape unisce le valenze tecniche del gres porcellanato alle peculiarità estetiche e alle cromie offerte dagli smalti ceramici.

Studiata espressamente per gli interni delle vasche è comunemente adatta, con la superficie Satin, anche per rivestimenti murali in genere.

Landscape Series combines the technical standards of porcelain stoneware and the aesthetic features and colours of ceramic glazes.

Specially designed for pool tanks, Landscape is also commonly used for wall cladding in general, in the Satin surface version.

La série Landscape réunit les valeurs techniques du grès cérame et les caractéristiques esthétiques et les tons des émaux céramiques.

Spécialement conçue pour les revêtements intérieurs des bassins, Landscape est néanmoins indiquée pour les revêtements muraux en général, grâce à la surface Satin.

Landscape verbindet die technischen Werte des Feinsteinzeugs mit den ästhetischen Besonderheiten und den Farbtönen der Keramikglasuren.

Das eigens für den Beckeninnenraum entwickelte Landscape eignet sich mit seine Satin Oberfläche auch für allgemeine Wandverkleidungen.

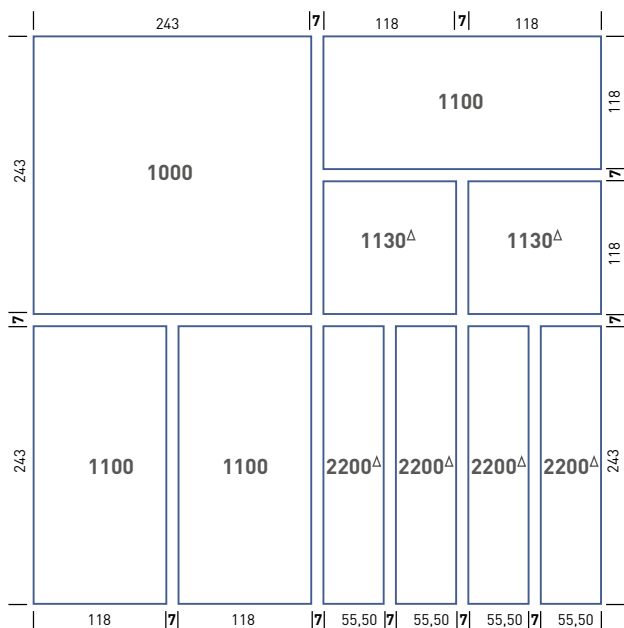

Codice formato Ref. format Format code Format Nr.	Misure di fabbricazione** Cotes de fabrication Worksizes Herstellmasse	Misure nominali Cotes nominales Nominal sizes Nennmasse
1000	243x243 mm 9 ^{9/16} " x 9 ^{9/16} "	M*25x25 cm M*9 ^{7/8} " x 9 ^{7/8} "
1130^Δ	118x118 mm 4 ^{5/8} " x 4 ^{5/8} "	M*12,5x12,5 cm M*4 ^{7/8} " x 4 ^{7/8} "
1100	118x243 mm 4 ^{5/8} " x 9 ^{9/16} "	M*12,5x25 cm M*4 ^{7/8} " x 9 ^{7/8} "
2200^Δ	55,5x243 mm 2 ^{3/16} " x 9 ^{9/16} "	M*6,25x25 cm M*2 ^{1/2} " x 9 ^{7/8} "

^Δ Pezzo speciale ottenuto da taglio del formato M12,5x25 cm, con tre lati non rettificati ed uno leggermente bisellato (venduto al pezzo - vedi pag.38) Special fitting obtained by cutting size M12,5x25 cm with three not/rectified edges and one slightly bevelled (sold per piece - see page 38) Pièce spéciale obtenue par découpe à partir du format M12,5x25 cm, avec trois cotes non rectifiées et un légèrement biseauté (vendue à l'unité - voir page 38) Formstücke erhalten durch Zuschneiden der Größe M12,5x25 cm, wobei drei Seiten nicht begradigt und eine leicht abgeschrägt ist (Verkauf stückweise - Siehe Seite 38)

* M = formato modulare modular size format modulaire modulformat

Importante: La modularità dei formati si ottiene con fuga di 7 mm

Important: Modularity of different sizes is based on 7 mm grouting joints.

Important: La modularité des formats est calculée avec un joint de 7 mm

Wichtig: Für Modulverlegung die empfohlene Fugenbreite ist 7 mm

** Calibro 0 Caliber 0 Pige 0 Kaliber 0

piastrelle in gres porcellanato smaltato / glazed porcelain tiles /
carreaux en grés cérame émaillé / glasierte Feinsteinzeugfliesen



Landscape - GRESPLUS



ESEMPIO CODIFICA PRODOTTI EXAMPLE PRODUCTS CODING EXAMPLE DE CODIFICATION DES PRODUITS BEISPIEL CODIERUNG DER PRODUKTE

Codice Code Code Kode	Codice formato o sagoma prodotto Code for size or shape of the product Code du format ou forme du produit Kode des Format oder Stückform des Artikels	Codice colore Colour code Code de la couleur Farbkode	Tipo di superficie Surface type Type de surface Oberflächenart
1100 202G	1100 = M12,5x25 cm / M4 ^{7/8} "x9 ^{7/8} "	202 = Ocean	G = Grip
1106 200S	1106 = Pezzo speciale / Fitting / Pièce spéciale / Formstück	200 = Bay	S = Satin

Landscape

GRESPLUS superfici

SURFACES
SURFACES
OBERFLÄCHEN

Satin = S

È realizzata con smalti semi-lucidi e resta scivolosa se bagnata. Risulta pertanto adatta per rivestire pareti e fondo di vasche e per realizzare rivestimenti murali.

This surface is made with semi-gloss enamels and turns out slippery when wet. It is especially suitable for cladding walls and deep bottoms of pools and for other wall applications.

Cette surface est réalisée avec des émaux semi-brillants et se maintient glissante si mouillée. Spécialement indiquée pour les revêtements des parois et des fonds supérieurs à 1.5 m des bassins et pour les revêtements muraux.

Es handelt sich um Oberfläche mit mattglänzenden Glasuren und feuchtem Zustand rutschig bleiben. Satin eignet sich daher zur Verkleidung der Schwimmbeckenwände- und böden sowie für Wandverkleidungen.

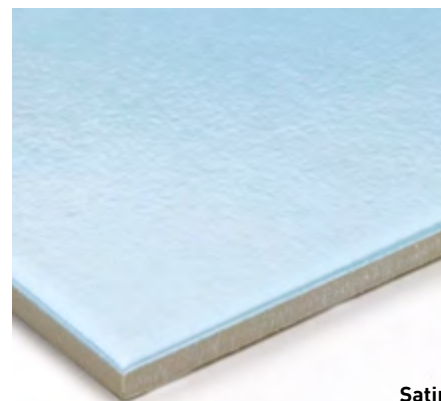

Satin

DIN 51097 XP P 05-010
A PN 12



Grip = G

È una superficie opaca ruvida ma non strutturata, con un grado antiscivolo di gruppo C a piedi nudi. Può essere usata per bordi vasca, scale e gradini immersi in acqua, vasche lavapiedi e piani inclinati con forti pendenze. Può essere usata anche per le zone per le quali è richiesto un gruppo antiscivolo di gruppo B, come ad esempio: per vasche a profondità limitata, zone di virata nelle piscine sportive, sdrai e sedute di panche immerse in acqua.

It is a rough matt but unstructured surface with a Group C barefoot anti-slip degree. Recommended for pool borders, underwater stairs and steps, feet washers and ramps. It can be used also for zones for which a Group B barefoot anti-slip degree is requested, such as: limited depth pool, turning areas in competition pools, underwater benches.

Surface mate rugueuse mais non structurée, avec un degré anti-glissance pieds nus de groupe C. Recommandée pour têtes de bassin, escaliers et marches plongées dans l'eau, pédiluves et plans inclinés à forte pente. Cette finition peut être aussi utilisée pour les zones pour lesquelles il est demandé un degré anti-glissance pieds nus de groupe B, comme par exemple: bassins à profondeur limitée, zones de virage dans les piscines sportives, banquettes plongées dans l'eau.

Es ist eine raue, aber nicht strukturierte matte Oberfläche, mit einem Rutschfestigkeitsklasse Gruppe C bei barfüssigem Betreten. Es kann für Beckenränder, unter Wasser positionierte Treppen und Stufen, Durschschreitbecken und schräge Flächen mit einem starken Neigung verwendet werden. Es kann auch für Bereiche verwendet werden, für die eine Rutschfestigkeitsklasse der Gruppe B erforderlich ist, z. B. für Becken mit geringer Tiefe, Wendebereiche in Sportbecken, und für unter Wasser positionierte Liegestühle und Sitzbänke.

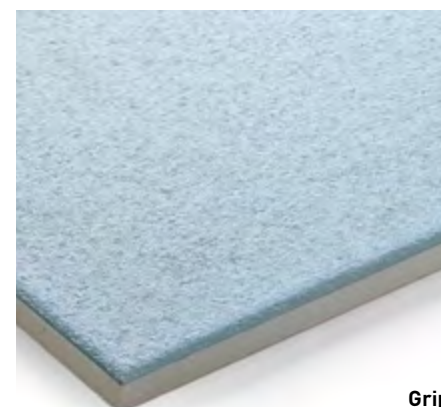

Grip

DIN 51097 XP P 05-010
C PN 24



Rigata-Cannelé = C

Dedicata al pezzo speciale 3200 (vedi pag. 39), questa superficie è caratterizzata da righe in rilievo da posare trasversalmente al senso di marcia per poter beneficiare di un grado di antiscivolosità di gruppo C ed essere utilizzata, come alternativa alla superficie Grip, per bordi vasca, scale e gradini immersi in acqua, vasche lavapièdi e piani inclinati con forte pendenza.

This surface is focused on the special fitting 3200 (see page 39) and it is characterized by relief grooves to be arranged crosswise to traffic direction in order to ensure a Group C barefoot non-slip degree and to be used, as an alternative to the Grip surface, for pool borders, underwater stairs and steps, feet washers and ramps.

Cette surface est destinée à la pièce spéciale 3200 (voir pag. 39), étant caractérisée par des cannelures en relief à poser transversalement au sens de marche pour bénéficier d'un degré antiglissance pieds nus de groupe C et pour être utilisé, comme alternative à la finition Grip, pour têtes de bassin, escaliers et marches plongés dans l'eau, pédiluves et plans inclinés à forte pente.

Diese Oberfläche ist für das Formstück 3200 (siehe Seite 39) bestimmt und zeichnet sich durch Reliefstreifen aus, die quer zur Laufrichtung verlegt werden sollen, um einen Rutschfestigkeitsklasse der Gruppe C zu erhalten und als Alternative zur Oberfläche Grip zu verwenden, für Beckenränder, unter Wasser positionierte Treppen und Stufen, Durchschreitbecken und schräge Flächen mit starker Neigung.

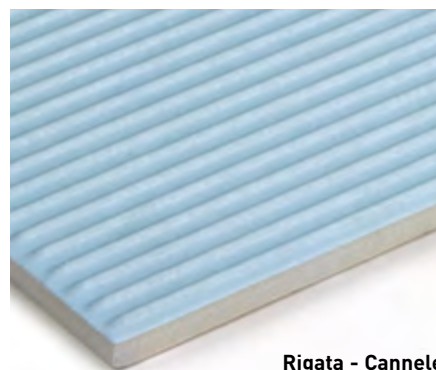

Rigata - Cannelé

DIN 51097 C	XP P 05-010 PN 24	DIN 51130 V 8	
----------------	----------------------	------------------	---



LANDSCAPE

Gruppo B1a

8 mm

Tundra 100

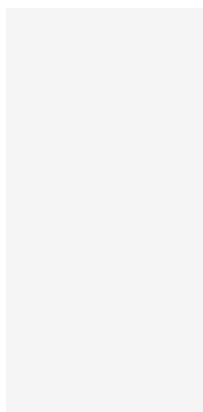

Satin	
1100 100S	M12,5x25 cm / M4 ^{7/8} " x9 ^{7/8} "
1000 100S	M25x25 cm / M9 ^{7/8} " x9 ^{7/8} "
1130 100S ^Δ	M12,5x12,5 cm / M4 ^{7/8} " x4 ^{7/8} "
2200 100S ^Δ	M6,25x25 cm / M2 ^{1/2} " x9 ^{7/8} "

Grip	
1100 100G	M12,5x25 cm / M4 ^{7/8} " x9 ^{7/8} "
1130 100G ^Δ	M12,5x12,5 cm / M4 ^{7/8} " x4 ^{7/8} "

Bay 200

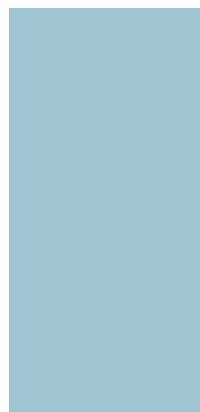

Satin	
1100 200S	M12,5x25 cm / M4 ^{7/8} " x9 ^{7/8} "
1130 200S ^Δ	M12,5x12,5 cm / M4 ^{7/8} " x4 ^{7/8} "
2200 200S ^Δ	M6,25x25 cm / M2 ^{1/2} " x9 ^{7/8} "

Grip	
1100 200G	M12,5x25 cm / M4 ^{7/8} " x9 ^{7/8} "
1130 200G ^Δ	M12,5x12,5 cm / M4 ^{7/8} " x4 ^{7/8} "

Ocean 202



Satin	
1100 202S	M12,5x25 cm / M4 ^{7/8} " x9 ^{7/8} "
1130 202S ^Δ	M12,5x12,5 cm / M4 ^{7/8} " x4 ^{7/8} "
2200 202S ^Δ	M6,25x25 cm / M2 ^{1/2} " x9 ^{7/8} "

Grip	
1100 202G	M12,5x25 cm / M4 ^{7/8} " x9 ^{7/8} "
1130 202G ^Δ	M12,5x12,5 cm / M4 ^{7/8} " x4 ^{7/8} "

Bahama 501

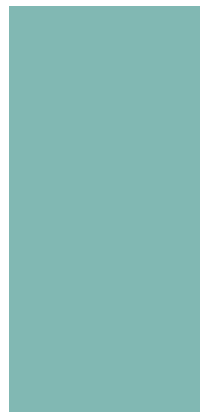

Satin	
1100 501S	M12,5x25 cm / M4 ^{7/8} " x9 ^{7/8} "





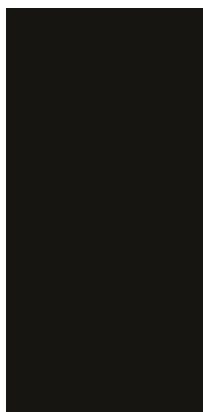



















Grip	
1100 501G	M12,5x25 cm / M4 ^{7/8} " x9 ^{7/8} "

Lava 700



Satin	
1100 700S	M12,5x25 cm / M4 ^{7/8} " x9 ^{7/8} "

Grip	
1100 700G	M12,5x25 cm / M4 ^{7/8} " x9 ^{7/8} "

Formati Sizes Formats Formate	 1130^Δ cm M* 12,5x12,5 4 ^{7/8} " x 4 ^{7/8} "	 2200^Δ cm M* 6,25x25 2 ^{1/2} " x 9 ^{7/8} "	 1100 cm M* 12,5x25 4 ^{7/8} " x 9 ^{7/8} "	 1000 cm M* 25x25 9 ^{7/8} " x 9 ^{7/8} "
Spessori Thicknesses Epaisseurs Stärken	mm 8	mm 8	mm 8	mm 8
Bahama 501			 	
Bay 200	 		 	
Lava 700			 	
Ocean 202	 		 	
Tundra 100	 		 	

● Satin

● Grip

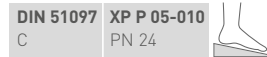
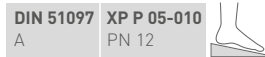









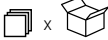





^Δ Pezzo speciale ottenuto da taglio del formato M12,5x25 cm, con tre lati non rettificati ed uno leggermente bisellato (venduto al pezzo - vedi pag.38) Special fitting obtained by cutting size M12,5x25 cm with three not/rectified edges and one slightly bevelled (sold per piece - see page 38) Pièce spéciale obtenue par découpe à partir du format M12,5x25 cm, avec trois cotes non rectifiées et un légèrement biseauté (vendue à l'unité - voir page 38) Formstücke erhalten durch Zuschneiden der Größe M12,5x25 cm, wobei drei Seiten nicht begradigt und eine leicht abgeschrägt ist (Verkauf stückweise - Siehe Seite 38)

* M = formato modulare modular size format modulaire modulformat

Caratteristiche tecniche a pagina: Technical features on page: Caractéristiques techniques à la page: Technische Eigenschaften auf Seite: 206

PESI, MISURE E CONTENUTO DEI COLLI WEIGHT, SIZE AND CONTENTS OF THE PACKING
POIDS, DIMENSIONS, CONTENU DES COLIS VERPACKUNGSRÖSSEN/GEWICHTE

Formati Sizes Format Format	 x 		 x 	 x 	 x 	 x 	 x 	 x 
	Satin	Grip						
1100 M12,5x25	32	32	32	1,00	78	78,00	17,00	1326,00
1000 M25x25	16	16	16	1,00	78	78,00	17,00	1326,00

LANDSCAPE

MOSAICI

8 mm

FORMATI SIZES FORMATS FORMAT

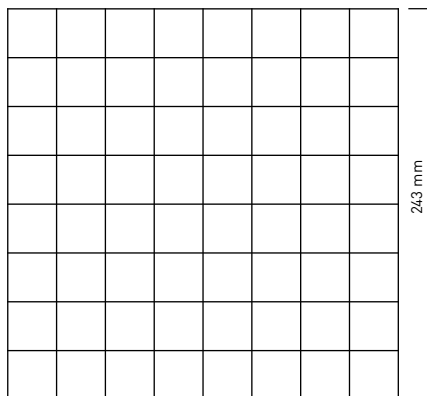

2,9x2,9 cm / 1 1/8"x1 1/8"

M 25x25 cm / M 9 7/8"x9 7/8"

29 mm



Fornito in fogli con rete davanti*

Supplied on sheets with net on good face*

Livré en plaques avec trame sur belle face*

Geliefert mit Netz auf Vorderseite*

* Vedi dettagli a pagina: See details on page: Voir détails à la page: Siehe Details auf Seite: 210

VANTAGGI ADVANTAGES AVANTAGES VORTEILE

Stesso spessore delle piastrelle Landscape

Same thickness of tiles of Series Landscape

Même épaisseur des carreaux Landscape

Gleiche Stärke der Platten der Serie Landscape

Stessi colori delle piastrelle Landscape

Same colours of tiles of Series Landscape

Mêmes couleurs des carreaux Landscape

Gleiche Farben der Platten der Serie Landscape

Modulare con i formati piscine

Modular with swimming pool sizes

Modulaire avec les formats piscines

Modulaer mit den Schwimmbadformaten



LS Mix 840



2700 840S

Tundra/Bay/Ocean Satin



LS Uni Tundra

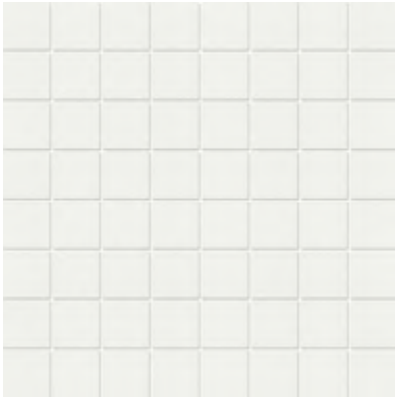

2700 100S

Tundra Satin



2700 100G

Tundra Grip

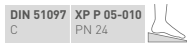

DIN 51097 XP P 05-010 PN 24

LS Uni Bay

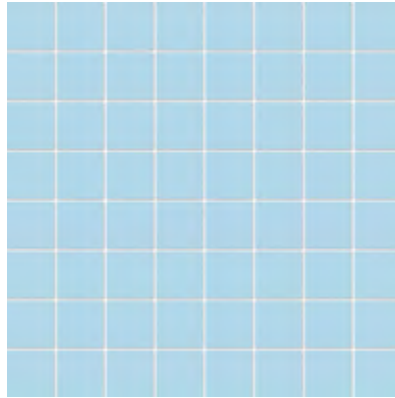

2700 200S

Bay Satin



2700 200G

Bay Grip

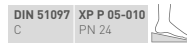

DIN 51097 XP P 05-010 PN 24

LS Uni Ocean

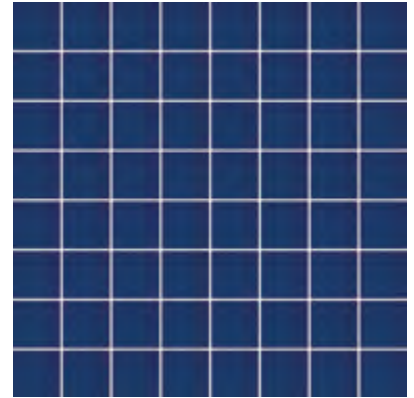

2700 202S

Ocean Satin



2700 202G

Ocean Grip



DIN 51097 XP P 05-010 PN 24

PEZZI SPECIALI FITTINGS PIECES SPECIALES FORMSTÜCKE

Bordo arrotondato Bord arrondi Bullnose Stehsockel



2706 100S

LS-UNI B.C.

Tundra Satin



2706 100G

LS-UNI B.C.

Tundra Grip

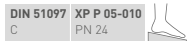

DIN 51097 XP P 05-010 PN 24

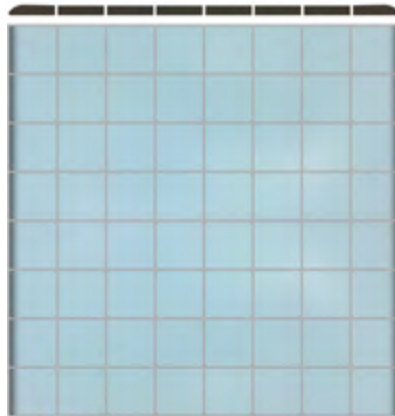

2706 200S

LS-UNI B.C.

Bay Satin



2706 200G

LS-UNI B.C.

Bay Grip

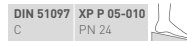

DIN 51097 XP P 05-010 PN 24

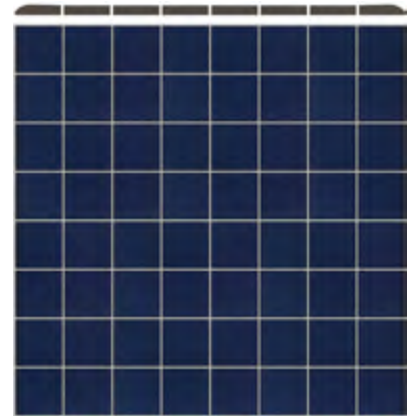

2706 202S

LS-UNI B.C.

Ocean Satin



2706 202G

LS-UNI B.C.

Ocean Grip



DIN 51097 XP P 05-010 PN 24

Elementi

GRANITOGRES

piastrelle in gres porcellanato non smaltato

UNGLAZED PORCELAIN TILES
CARREAUX EN GRES CERAME NON EMAILLE
UNGLASIERTE FEINSTEINZEUGFLIESEN

Gres porcellanato non smaltato colorato in massa e completamente vetrificato; Elementi è la serie di prodotti più resistente allo stress fisico, meccanico e chimico indicata quindi, con le idonee superfici, per tutti i tipi di pavimentazione, interne o esterne, degli ambienti piscina.

Le diverse superfici antiscivolo sono tutte realizzate profilando la materia stessa per garantire nel tempo la durata dei coefficienti antiscivolo originali.

Unglazed, mass-coloured and fully vitrified stoneware; Elementi is the most resistant product line to physical, mechanical and chemical stress. Therefore it is indicated, using the proper surface finish for all types of floors indoor and outdoor.

The different non-slip surfaces are formed by profiling the tile body directly, in order to secure durability of the original non-slip coefficients.

Grès cérame non émaillé, coloré et vitrifié pleine masse ; Elementi est la série aux propriétés de résistance mécanique et chimique plus performantes et elle donc indiquée, en utilisant la surface adéquate, pour tous les types de carrelages, à l'intérieur comme à l'extérieur.

Les différentes finitions antidérapantes sont réalisées moyennant la création de rugosités directement dans la matière, pour garantir la durée des coefficients antidérapants originaux.

In der Masse gefärbtes und vollkommen durchgesintertes unglasiertes Feinsteinzeug; Elementi ist eine gegenüber physischen, mechanischen und chemischen Belastungen widerstandsfähige Produktreihe mit den geeigneten Oberflächen für jegliche Fußböden im Innen- und Außenbereich.

Die verschiedenen rutschsicheren Oberflächen wurden mittels der Profilierung der Materie hergestellt, um auch langfristig den ursprünglichen Rutschfestigkeitskoeffizienten gewährleisten zu können.

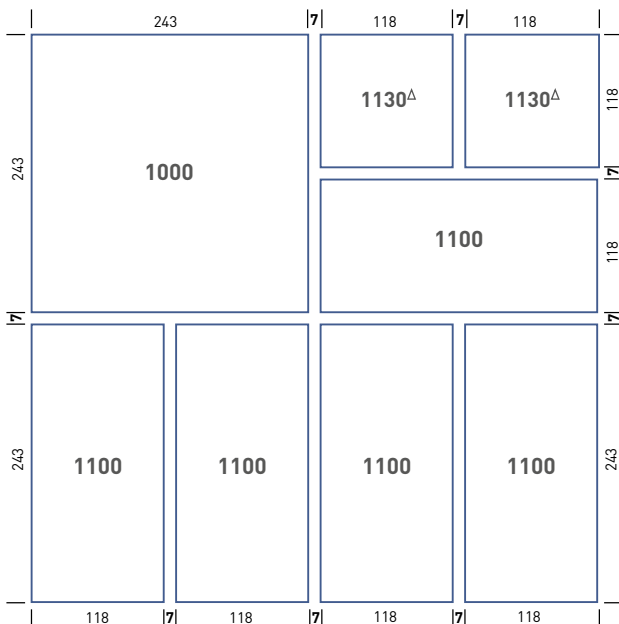

Codice formato Ref. format Format code Format Nr.	Misure di fabbricazione** Cotes de fabrication Worksizes Herstellmasse	Misure nominali Cotes nominales Nominal sizes Nennmasse
1000	243x243 mm 9 ⁹ / ₁₆ " x 9 ⁹ / ₁₆ "	M*25x25 cm M*9 ⁷ / ₈ " x 9 ⁷ / ₈ "
1130^Δ	118x118 mm 4 ⁵ / ₈ " x 4 ¹ / ₆₄ "	M*12,5x12,5 cm M*4 ⁷ / ₈ " x 4 ⁷ / ₈ "
1100	118x243 mm 4 ⁵ / ₈ " x 9 ⁹ / ₁₆ "	M*12,5x25 cm M*4 ⁷ / ₈ " x 9 ⁷ / ₈ "

^Δ Pezzo speciale ottenuto da taglio del formato M12,5x25 cm, con tre lati non rettificati ed uno leggermente bisellato (venduto al pezzo - vedi pag.38) Special fitting obtained by cutting size M12,5x25 cm with three not/rectified edges and one slightly bevelled (sold per piece - see page 38) Pièce spéciale obtenue par découpe à partir du format M12,5x25 cm, avec trois cotes non rectifiées et un légèrement biseauté (vendue à l'unité - voir page 38) Formstücke erhalten durch Zuschneiden der Größe M12,5x25 cm, wobei drei Seiten nicht begradigt und eine leicht abgeschrägt ist (Verkauf stückweise - Siehe Seite 38)

* M = formato modulare modular size format modulaire modulformat
Importante: La modularità dei formati si ottiene con fuga di 7 mm
Important: Modularity of different sizes is based on 7 mm grouting joints.
Important: La modularité des formats est calculée avec un joint de 7 mm
Wichtig: Für Modulverlegung die empfohlene Fugenbreite ist 7 mm

** Calibro 0 Caliber 0 Pige 0 Kaliber 0

piastrelle in gres porcellanato non smaltato / unglazed porcelain tiles /
carreaux en grés cérame non émaillé / unglasierte Feinsteinzeugfliesen



Elementi - GRANITOGRES

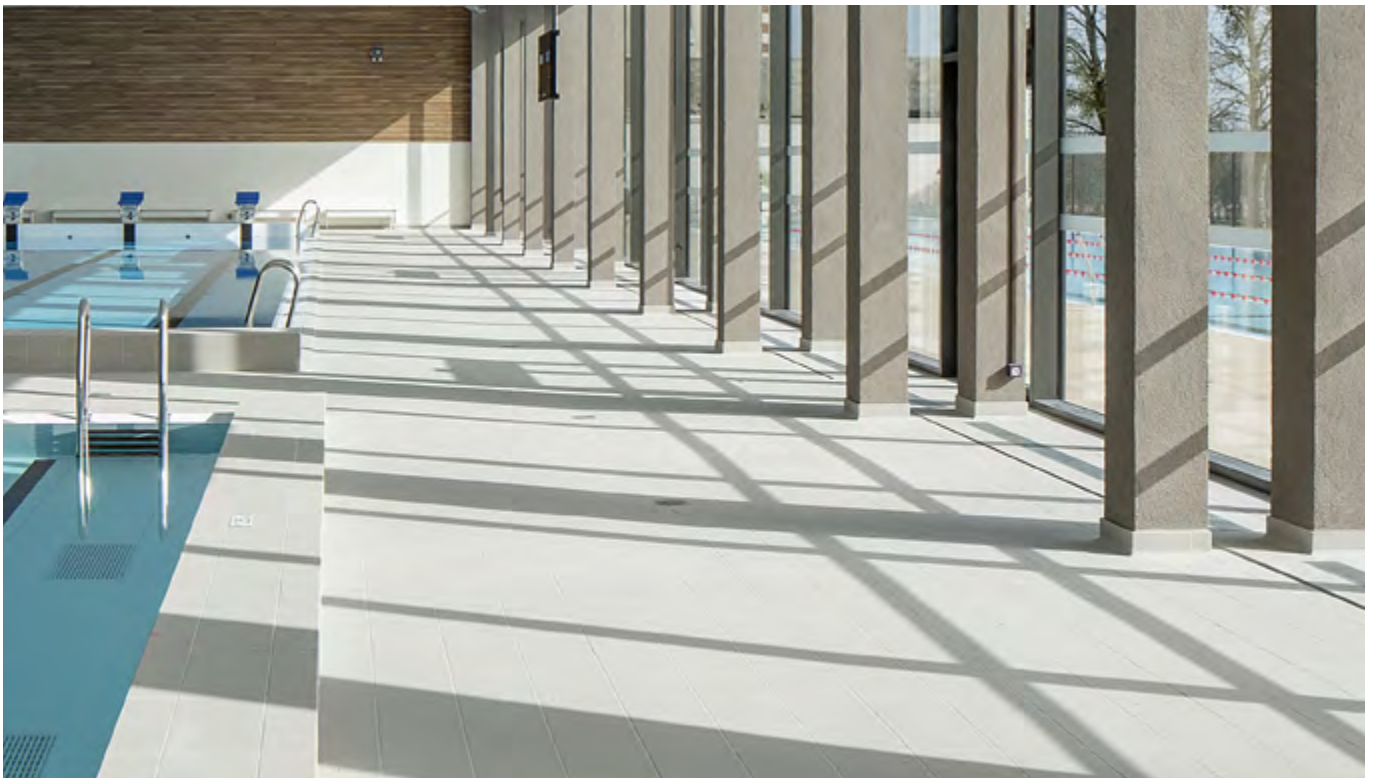

ESEMPIO CODIFICA PRODOTTI EXAMPLE PRODUCTS CODING EXAMPLE DE CODIFICATION DES PRODUITS BEISPIEL CODIERUNG DER PRODUKTE

Codice Code Code Kode	Codice formato o sagoma prodotto Code for size or shape of the product Code du format ou forme du produit Kode des Format oder Stückform des Artikels	Codice colore Colour code Code de la couleur Farbkode	Tipo di superficie Surface type Type de surface Oberflächenart
1100 010P	1100 = M12,5x25 cm / M4 ^{7/8} " x 9 ^{7/8} "	010 = Talco	P = Pinhead
1106 011M	1106 = Pezzo speciale / Fitting / Pièce spéciale / Formstück	011 = Avorio	M = Matt

Elementi

GRANITOGRES superfici

SURFACES
SURFACES
OBERFLÄCHEN

Matt = M

È caratterizzata da una leggera rugosità con un valore antiscivolo di gruppo B a piedi nudi ed il grado R10 a piedi calzati. È adatta per le aree intorno alle vasche, ma anche per spogliatoi e corridoi, generalmente umidi, sia all'interno che all'esterno.

Characterized by a slight rough surface finish with Group B barefoot non-slip and R10 shoed non-slip degree. Suitable for pool decks, but also locker rooms and corridors generally wet, both indoors and outdoors.

Caractérisée par une légère rugosité avec coefficient antidérapant pieds nus de groupe B et degré pieds chaussés R10. Indiquée pour les plages des piscines, les vestiaires, les couloirs et les zone mouillées, à l'intérieur comme à l'extérieur.

Ist durch eine leichte Oberflächenrauheit mit einem Rutschfestigkeitskoeffizienten der Gruppe B bei barfüßigem Betreten und der Gruppe R10 bei Betreten mit Schuhwerk gekennzeichnet. Eignet sich für die Beckenumgänge, aber auch für üblicherweise feuchte Umkleidekabinen und Flure, sowohl im Innen- als auch im Außenbereich.

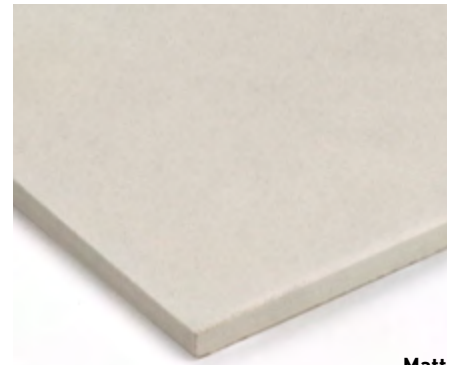

Matt

DIN 51097 B	XP P 05-010 PN 18	
DIN 51130 R 10 V	XP P 05-010 PC 10	

Pinhead = P

Evidenzia profili semi-sferici a rilievo che garantiscono un valore antiscivolo di gruppo C a piedi nudi e il grado R11 a piedi calzati. La regolare disposizione dei rilievi, oltre a facilitare la pulizia, permette un deflusso dei liquidi di classe V6 (Norma DIN 51130) riducendo ristagni di acqua evitando fenomeni di aquaplaning. Realizzata anche su alcuni pezzi speciali per bordo vasca, è sicuramente il tipo di superficie più indicato per le aree adiacenti alle vasche e altre zone generalmente bagnate o immerse in acqua.



Features semi-spherical relief profiles that guarantee Group C barefoot non-slip coefficient and R11 shoed non-slip degree. The regular arrangement of the profiles allows for easy cleaning and V6-class fluid flow (according to DIN 51130), which prevents water accumulation and aquaplaning. Also available on some fittings for pool borders, this is undoubtedly the most suitable surface for pools decks and other wet and/or submerged areas.

Caractérisée par des picots semi-sphériques en relief qui garantissent un coefficient antidérapant pieds nus de groupe C et le degré pieds chaussés R11. La disposition régulière des reliefs permet un nettoyage facile et l'écoulement des fluides de classe V6 (conformément à la norme DIN 51130), ce qui permet d'éviter des accumulations d'eau et de prévenir les phénomènes d'aquaplaning. Réalisée également sur certaines pièces spéciales pour les têtes des bassins, cette surface est sans aucun doute la plus indiquée pour les plages des piscines et toute autre zone généralement mouillée ou plongée dans l'eau.

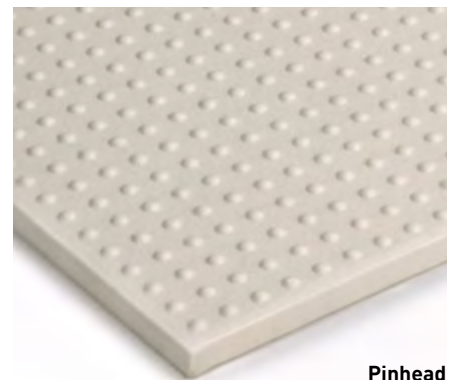
Weist halbrunde erhöhte Profile auf, die einen Rutschfestigkeitskoeffizienten der Gruppe C bei barfüßigem Betreten und der Gruppe R11 bei Betreten mit Schuhwerk gewährleisten. Die regelmäßige Anordnung der Profile vereinfacht nicht nur die Reinigung, sondern schafft auch einen Verdrängungsraum, der der Klasse V6 (Norm DIN 51130) entspricht, wodurch Wasseranstauungen reduziert und Aquaplaning-Phänomene vermieden werden können. Diese Oberfläche, mit der auch einige Formteile für Schwimmbeckenränder hergestellt werden, eignet sich mit Gewissheit für die Beckenumgänge und für andere Zonen, die üblicherweise feucht oder unter Wasser sind.



Pinhead

DIN 51097 C	XP P 05-010 PN 24	
DIN 51130 R 11 V 6	XP P 05-010 PC 20	

Roccia = R

La superficie ha una struttura irregolare con un grado di antiscivolosità di gruppo C a piedi nudi ed il valore di R12 a piedi calzati. L'aspetto tipo "spaccato di pietra" rende preferibile questo tipo di superficie per pavimentazioni in esterno.

Irregular surface structure with Group C barefoot non-slip coefficient and R12 shoed non-slip coefficient. This "stone look" effect makes this surface finish an ideal solution for outdoor applications.

Surface à structure irrégulière avec coefficient antidérapant pieds nus de groupe C et degré pieds chaussés R12. Son « effet pierre » fait de cette surface le revêtement idéal pour toutes les applications extérieures.

Die Oberfläche hat eine unregelmäßige Struktur mit einem Rutschfestigkeitskoeffizienten der Gruppe C bei barfüßigem Betreten und der Gruppe R12 bei Betreten mit Schuhwerk. Das typische "Spaltstein"-Aussehen macht diese Oberflächenart besonders für Fußböden im Außenbereich geeignet.



Roccia

DIN 51097 C	XP P 05-010 PN 24	
DIN 51130 R 12 V	XP P 05-010 PC 27	

Rigata-Cannelé = C

Dedicata al pezzo speciale 3200 (vedi pag. 39), questa superficie è caratterizzata da righe in rilievo da posare trasversalmente al senso di marcia per poter beneficiare di un grado di antiscivolosità di gruppo C a piedi nudi.

This surface is focused on the special fitting 3200 (see page 39) and it is characterized by relief grooves to be arranged crosswise to traffic direction in order to ensure a Group C barefoot anti-slip value.

Cette surface est destinée à la pièce spéciale 3200 (voir pag. 39), étant caractérisée par des cannelures en relief à poser transversalement au sens de marche pour bénéficier d'un degré antiglissance pieds nus de groupe C.

Diese Oberfläche ist für das Formstück 3200 (siehe Seite 39) bestimmt und zeichnet sich durch Reliefstreifen aus, die quer zur Laufrichtung verlegt werden sollen, um einen Rutschfestigkeitsklasse der Gruppe C zu erhalten.



Rigata - Cannelé

DIN 51097 C	XP P 05-010 PN 24	
DIN 51130 R 12 V 8	XP P 05-010 PC 27	

ELEMENTI

Gruppo B1a UGL

8 mm

Talco 010

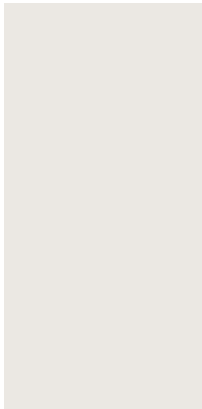

Matt	
1100 010M	M12,5x25 cm / M4 ^{7/8} "x9 ^{7/8} "
1000 010M	M25x25 cm / M9 ^{7/8} "x9 ^{7/8} "
1130 010M ^Δ	M12,5x12,5 cm / M4 ^{7/8} "x4 ^{7/8} "
Pinhead	
1100 010P	M12,5x25 cm / M4 ^{7/8} "x9 ^{7/8} "
1000 010P	M25x25 cm / M9 ^{7/8} "x9 ^{7/8} "
1130 010P	M12,5x12,5 cm / M4 ^{7/8} "x4 ^{7/8} "
Roccia	
1000 010R	M25x25 cm / M9 ^{7/8} "x9 ^{7/8} "

Avorio 011



Matt	
1100 011M	M12,5x25 cm / M4 ^{7/8} "x9 ^{7/8} "
1000 011M	M25x25 cm / M9 ^{7/8} "x9 ^{7/8} "
1130 011M ^Δ	M12,5x12,5 cm / M4 ^{7/8} "x4 ^{7/8} "
Pinhead	
1100 011P	M12,5x25 cm / M4 ^{7/8} "x9 ^{7/8} "
1000 011P	M25x25 cm / M9 ^{7/8} "x9 ^{7/8} "
1130 011P ^Δ	M12,5x12,5 cm / M4 ^{7/8} "x4 ^{7/8} "

Cemento 060

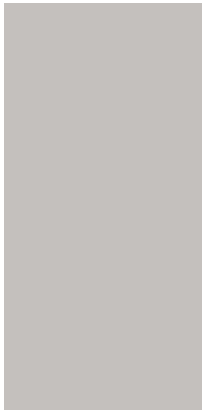

Matt	
1100 060M	M12,5x25 cm / M4 ^{7/8} "x9 ^{7/8} "
1000 060M	M25x25 cm / M9 ^{7/8} "x9 ^{7/8} "
Pinhead	
1100 060P	M12,5x25 cm / M4 ^{7/8} "x9 ^{7/8} "
1000 060P	M25x25 cm / M9 ^{7/8} "x9 ^{7/8} "
Roccia	
1000 060R	M25x25 cm / M9 ^{7/8} "x9 ^{7/8} "

Basalto 061



Matt	
1100 061M	M12,5x25 cm / M4 ^{7/8} "x9 ^{7/8} "
Pinhead	
1100 061P	M12,5x25 cm / M4 ^{7/8} "x9 ^{7/8} "
1000 061P	M25x25 cm / M9 ^{7/8} "x9 ^{7/8} "

Ebano 070

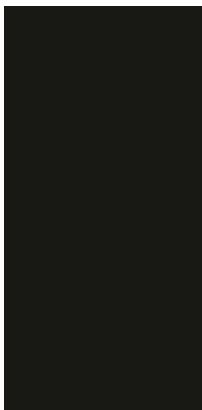



Matt	
1100 070M	M12,5x25 cm / M4 ^{7/8} "x9 ^{7/8} "
Pinhead	
1100 070P	M12,5x25 cm / M4 ^{7/8} "x9 ^{7/8} "
1000 070P	M25x25 cm / M9 ^{7/8} "x9 ^{7/8} "

Mare 021





Matt	
1100 021M	M12,5x25 cm / M4 ^{7/8} "x9 ^{7/8} "
1130 021M ^Δ	M12,5x12,5 cm / M4 ^{7/8} "x4 ^{7/8} "
Pinhead	
1100 021P	M12,5x25 cm / M4 ^{7/8} "x9 ^{7/8} "
1000 021P	M25x25 cm / M9 ^{7/8} "x9 ^{7/8} "
1130 021P ^Δ	M12,5x12,5 cm / M4 ^{7/8} "x4 ^{7/8} "



Formati Sizes Formats Formate	 1130^Δ cm M* 12,5x12,5 4 ^{7/8} " x 4 ^{7/8} "	 1100 cm M* 12,5x25 4 ^{7/8} " x 9 ^{7/8} "	 1000 cm M* 25x25 9 ^{7/8} " x 9 ^{7/8} "
Spessori Thicknesses Epaisseurs Stärken	mm 8	mm 8	mm 8
Avorio 011	● ●	● ●	● ●
Basalto 061		● ●	●
Cemento 060		● ●	● ● ●
Ebano 070		● ●	●
Mare 021	● ●	● ●	●
Talco 010	● ●	● ●	● ● ●



● Matt

● Pinhead

● Roccia

DIN 51097 B	XP P 05-010 PN 18	
DIN 51130 R 10 V	XP P 05-010 PC 10	

DIN 51097 C	XP P 05-010 PN 24	
DIN 51130 R 11 V 6	XP P 05-010 PC 20	











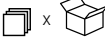



DIN 51097 C	XP P 05-010 PN 24	
DIN 51130 R 12 V	XP P 05-010 PC 27	

△ Pezzo speciale ottenuto da taglio del formato M12,5x25 cm, con tre lati non rettificati ed uno leggermente bisellato (venduto al pezzo - vedi pag.38) Special fitting obtained by cutting size M12,5x25 cm with three not/rectified edges and one slightly bevelled (sold per piece - see page 38) Pièce spéciale obtenue par découpe à partir du format M12,5x25 cm, avec trois cotes non rectifiées et un légèrement biseauté (vendue à l'unité - voir page 38) Formstücke erhalten durch Zuschneiden der Größe M12,5x25 cm, wobei drei Seiten nicht begradigt und eine leicht abgeschrägt ist (Verkauf stückweise - Siehe Seite 38)

* M = formato modulare modular size format modulaire modulformat

Caratteristiche tecniche a pagina: Technical features on page: Caractéristiques techniques à la page: Technische Eigenschaften auf Seite: 204

PESI, MISURE E CONTENUTO DEI COLLI WEIGHT, SIZE AND CONTENTS OF THE PACKING
POIDS, DIMENSIONS, CONTENU DES COLIS VERPACKUNGSRÖSSEN/GEWICHTE

	 x 	 x 	 x 	 x 	 x 	 x 	 x 	
1100 M12,5x25	Matt	32	32	1,00	78	78,00	17	1326
	Pinhead	30		0,938		73,12		1243
1000 M25x25	Matt	16	16	1,00	78	78,00	17	1326
	Pinhead	15		0,938		73,12		1243
	Roccia	16		1,00		78,00		1326

Padana Trim

pezzi speciali e sistema Trim-Box

TRADITIONAL FITTINGS AND TRIM-BOX SYSTEM
PIECES SPECIALES ET SYSTEME TRIM-BOX
TRADITIONELLE FORMSTÜCKE UND DAS SYSTEM TRIM-BOX

La realizzazione di piscine ed impianti sportivi richiede l'impiego di un gran numero di pezzi speciali in ceramica che consentano il rivestimento di sagome particolari e di adattarsi alle forme degli elementi costruttivi ed architettonici.

Accanto alla produzione di pezzi speciali tradizionali la divisione Swimming Pool di Casalgrande Padana ha creato l'esclusivo sistema Trim Box, un insieme di pezzi speciali di nuova concezione che, oltre a garantire un elevato livello estetico e qualitativo, facilita e velocizza le operazioni di messa in opera.

L'utilizzo del sistema Trim Box offre diversi vantaggi:

- I pezzi speciali dedicati alla realizzazione di bordi vasca di tipo finlandese hanno lo stesso spessore e non è perciò necessario creare sagome particolari nel cemento armato.
- Ogni pezzo dispone anche del relativo mezzo-pezzo per facilitare la realizzazione di bordi vasca con parti curve.
- Ogni elemento è disponibile nella duplice versione con e senza tallone in ceramica per il supporto della griglia.

Il sistema Trim-Box è particolarmente indicato per la realizzazione di piscine nell'ambito di impianti natatori sportivi e se ne raccomanda l'uso soltanto per vasche collocate in interno.

Swimming pools and sports facilities involve the use of a large number of fittings to clad specific profiles and shapes of architectural elements.

In addition to the production of traditional fittings, Casalgrande Padana's Swimming Pool Division designed the exclusive Trim-Box system, a collection of new-concept fittings that also improve the aesthetics while facilitating and simplifying installation.

The Trim-Box system offers a number of advantages:

- All fittings dedicated for Finnish pool borders have same thickness and therefore do not require the concrete to come in special shapes.
- Each reference is available in the half-size in order to facilitate the lay-out of curved pool borders.
- All elements are available with and without ceramic support for the grid.

The Trim-Box system is particularly suitable for pools in the context of sports facilities and its use is recommended for indoor pools only.

La construction de piscines et d'installations sportives exige le recours à plusieurs pièces céramiques spéciales pour le revêtement de certains profils et leur adaptation aux formes des éléments architecturaux.

En plus de la production de pièces spéciales traditionnelles, la division Swimming Pool de Casalgrande Padana a conçu le système exclusif Trim Box, un ensemble de pièces spéciales avant-gardistes qui tout en améliorant le niveau esthétique de l'ouvrage facilite et simplifie le travail de pose.

Le système Trim Box offre plusieurs avantages :

- Les pièces dédiées à la réalisation des têtes des bassins finlandaises ont la même épaisseur et n'exigent donc aucun façonnage dans le béton.
- Pour chaque référence est disponible la version en demi-pièce pour faciliter la réalisation des têtes de bassin arrondies.
- Toutes les références sont disponibles dans la version sans ou avec talon céramique pour le support de la grille.

Le système Trim-Box est particulièrement adapté pour piscines de centres nautiques et son utilisation est recommandée uniquement pour les piscines à l'intérieur.

Die Konstruktion von Schwimmbädern und Wassersportanlagen macht die Verwendung einer großen Anzahl von Keramikformstücken erforderlich, die die Verkleidung von außergewöhnlichen Profilen sowie die Anpassung an die Bauteile und an die architektonischen Elemente ermöglichen.

Nebst der Herstellung von traditionellen Formstücken hat die Abteilung Swimming Pool von Casalgrande Padana auch das exklusive System Trim Box entwickelt. Hierbei handelt es sich um ein Sortiment neu konzipierter Formteile, die nicht nur eine hochwertige Ästhetik und Spitzenqualität gewährleisten, sondern auch die Verlegungsarbeiten erleichtern und beschleunigen.

Die Verwendung des Systems Trim Box bietet verschiedene Vorteile:

- Die für die Konstruktion der finnischen Rinnen bestimmten Formteile haben dieselbe Stärke, und die Kreation besonderer Profile im Stahlbeton ist daher nicht erforderlich.
- Zur Vereinfachung der Verlegung von Beckenrändern mit Kurvenabschnitten ist für alle Formteile auch das halbierte Formteil verfügbar.
- Ein jedes Teil ist in doppelter Ausführung mit und ohne Keramiksockel für die Rostaufgabe erhältlich.

Das Trim-Box-System eignet sich besonders für Schwimmbecken in Schwimmanlagen und wird nur für Innenpools empfohlen.

Pezzi tradizionali
Traditional fittings
Pièces traditionnelles
Traditionelle Formstücke

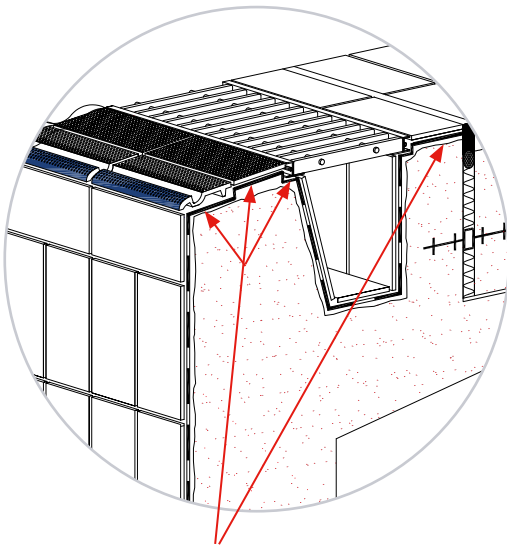

sagoma supporto irregolare
irregular shape of concrete
forme du beton irreguliere
unregelmässige stahlbeton

Sistema Trim-Box
Trim-Box system
Système Trim-Box
System Trim-Box

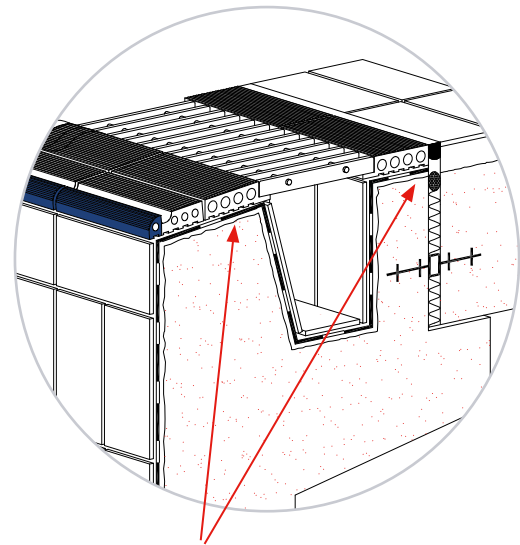

sagoma supporto lineare
linear shape of concrete
forme du beton lineaire
regelmässige stahlbeton



art. 7300



art. 7500

Polyfill

sistema di tamponamento dei pezzi Trim-Box

PLUGGING SYSTEM FOR TRIM-BOX FITTINGS
SYSTEME DE REMPLISSAGE DES PIÈCES TRIM-BOX
SYSTEM ZUM AUSFÜLLEN DER FORMTEILE TRIM BOX

Per migliorare l'ancoraggio del materiale utilizzato per le fughe e per contenere il peso dei pezzi, gli articoli del sistema Trim-Box sono stati progettati con uno o più fori passanti, all'interno dei quali è sempre consigliato alloggiare i profili Polyfill ad essi dedicati, consentendo inoltre di ridurre lo spreco di materiale fugante che altrimenti andrebbe a perdersi dentro i fori.



To improve the anchoring of the material used for the joints and to contain the weight of the pieces, the articles of the Trim-Box system have been designed with one or more through-holes, inside which it is always recommended to use the dedicated Polyfill profiles, also allowing to reduce the waste of joint material that would otherwise be lost inside the holes.

Pour améliorer l'ancrage du matériau utilisé pour les joints et contenir le poids des pièces, les articles du système Trim-Box ont été conçus avec un ou plusieurs trous traversants, à l'intérieur desquels il est toujours recommandé d'utiliser les profils Polyfill dédiés, permettant également de réduire le gaspillage des produits de Jointoiment qui seraient destinés, dans le cas contraire, à disparaître dans les trous.

Um die Verankerung des für die Fugen verwendeten Materials zu verbessern und das Gewicht der Teile zu halten, wurden die Artikel des Trim-Box-Systems mit einem oder mehreren Durchgangslöchern konzipiert, in denen es immer empfohlen wird, die dedizierten Polyfill-Profile zu verwenden, was auch dazu beiträgt, den Abfall von Fugendichtungsmaterial zu reduzieren, der sonst in den Löchern verloren gehen würde.

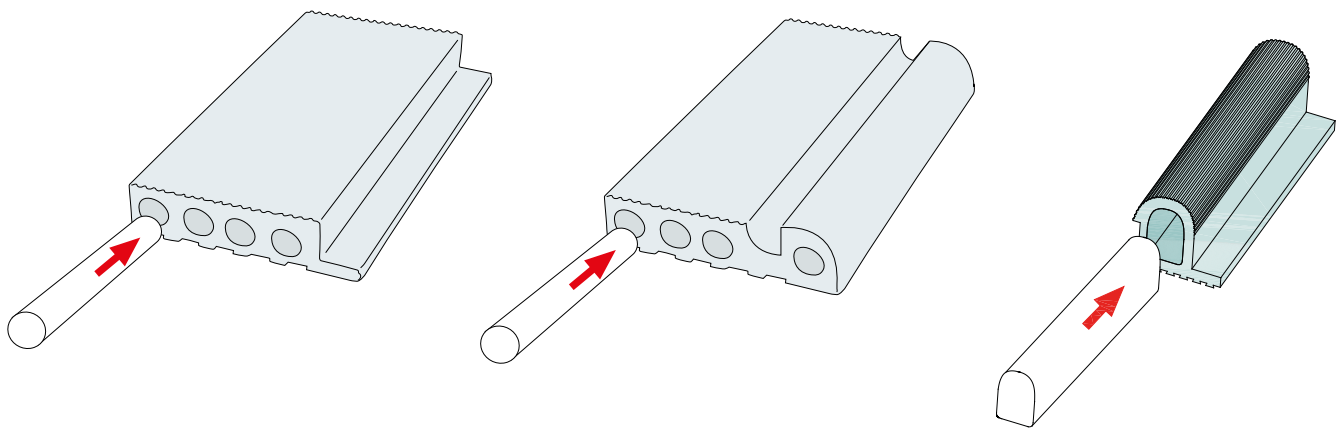

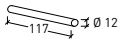
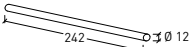
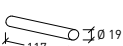

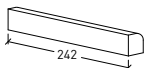
	Codice Code Code Code	Descrizione Description Description Beschreibung	Dimensioni Sizes Dimensions Format	Per articoli For items Pour articles Für artiklen	
	P107-0117	Polyfill cilindro Polyfill cylinder Polyfill cylindre Polyfill Zylinder	12x117 mm	7520 (4 pcs) - 7820 (4 pcs)	
	P106-0242		12x242 mm	7500 (4 pcs) - 7800 (4 pcs)	
	P103-0117		19x117 mm	8120 (4 pcs) - 8620 (4 pcs) - 8820 (4 pcs) 9042 (4 pcs) - 9542 (4 pcs)	
	P102-0242		19x242 mm	8100 (4 pcs) - 8600 (4 pcs) - 8800 (4 pcs) 9046 (4 pcs) - 9546 (4 pcs)	
	P105-0117		Polyfill profilo Polyfill profil Polyfill profile Polyfill Profil	117 mm	6020 (1 pcs) - 6520 (1 pcs)
	P104-0242			242 mm	6050 (1 pcs) - 6550 (1 pcs)

SUPPORTO GRIGLIA GRID SUPPORT CORNIERE SUPPORT DE GRILLE ROSTAUFLAGEWINKEL

Vedi pagina: See page: Voir page: Siehe Seite: **57**

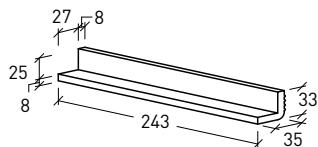

0500

Padana-Grid 36 pc/box 0,25 kg/pc 4 pc/ml

LANDSCAPE - Satin



100 Tundra

FORMATI M6,25x25 CM / M12,5x12,5 CM SIZES M6,25x25 CM / M12,5x12,5 CM FORMATS M6,25x25 CM / M12,5x12,5 CM FORMATEN M6,25x25 CM / M12,5x12,5 CM

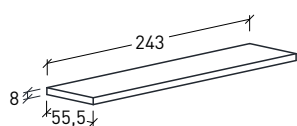

2200 Δ

64 pc/box 0,26 kg/pc

LANDSCAPE - Satin



100 Tundra 200 Bay 202 Ocean

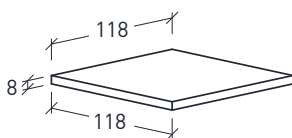

1130 Δ

64 pc/box 0,26 kg/pc

LANDSCAPE - Satin



100 Tundra 200 Bay 202 Ocean

LANDSCAPE - Grip



100 Tundra 200 Bay 202 Ocean

ELEMENTI - Matt



010 Talco 011 Avorio 021 Mare

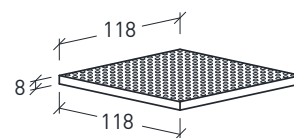

1130 PINHEAD Δ

60 pc/box 0,26 kg/pc

ELEMENTI - Pinhead



010 Talco 011 Avorio 021 Mare

BATTISCOPA E ANTISCIVOLO CON BORDO ARROTONDATO BULLNOSE AND NON SLIP WITH ROUNDED EDGE BORD ARRONDI ET ANTIDERAPANT AVEC BORD ARRONDI STEHSOCKEL UND NON- SLIP MIT GERUNDETE KANTE

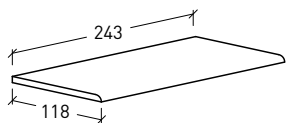

1106

32 pc/box 0,50 kg/pc 4 pc/ml (Satin)

26 pc/box 0,50 kg/pc 4 pc/ml (Matt)

LANDSCAPE - Satin



100 Tundra 200 Bay 202 Ocean

LANDSCAPE - Grip



100 Tundra 200 Bay 202 Ocean 700 Lava

ELEMENTI - Matt



010 Talco 011 Avorio 021 Mare



060 Cemento 061 Basalto 070 Ebano

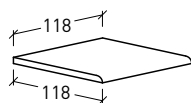

1126

64 pc/box 0,25 kg/pc 8 pc/ml

LANDSCAPE - Satin



100 Tundra 200 Bay 202 Ocean

LANDSCAPE - Grip



100 Tundra 200 Bay 202 Ocean

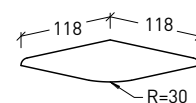

1109

10 pc/box 0,25 kg/pc

LANDSCAPE - Satin



100 Tundra 200 Bay 202 Ocean

LANDSCAPE - Grip



100 Tundra 200 Bay 202 Ocean 700 Lava

ELEMENTI - Matt



010 Talco 011 Avorio 021 Mare



060 Cemento 061 Basalto 070 Ebano

Δ Pezzo speciale ottenuto da taglio del formato M12,5x25 cm, con tre lati non rettificati ed uno leggermente bisellato Special fitting obtained by cutting size M12,5x25 cm with three not/rectified edges and one slightly bevelled Pièce spéciale obtenue par découpe à partir du format M12,5x25 cm, avec trois cotes non rectifiées et un légèrement biseauté Formstücke erhalten durch Zuschneiden der Größe M12,5x25 cm, wobei drei Seiten nicht begrädigt und eine leicht abgeschragt ist

PINHEAD CON BORDO ARROTONDATO PINHEAD WITH ROUNDED EDGE PINHEAD AVEC BORD ARRONDI PINHEAD MIT GERUNDETE KANTE

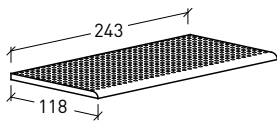
**1106**

26 pc/box 0,50 kg/pc 4 pc/ml

ELEMENTI - Pinhead

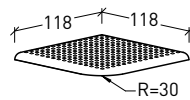
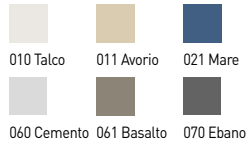
**1109**

10 pc/box 0,25 kg/pc

ELEMENTI - Pinhead

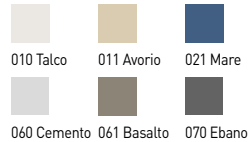

PIASTRELLA RIGATA RIBBED TILE CARREAU STRIE RILLENPLATTE

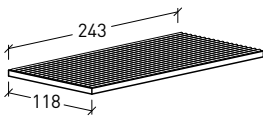
**3200**

28 pc/box 0,50 kg/pc 4 pc/ml

LANDSCAPE - Rigata*



ELEMENTI - Rigata**

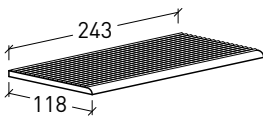

RIGATA CON BORDO ARROTONDATO RIBBED TILE WITH ROUNDED EDGE CARREAU STRIE AVEC BORD ARRONDI RILLENPLATTE MIT GERUNDETE KANTE

**3206**

28 pc/box 0,50 kg/pc 4 pc/ml

LANDSCAPE - Rigata*

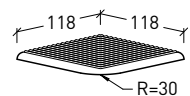

ELEMENTI - Rigata

**3209**

10 pc/box 0,25kg/pc

LANDSCAPE - Rigata



ELEMENTI - Rigata



* Colore 200 Bay su richiesta Colour 200 Bay on request Coloris 200 Bay sur demande Farbe 200 Bay auf Anfrage

** Colore 021 Mare su richiesta Colour 021 Mare on request Coloris 021 Mare sur demande Farbe 021 Mare auf Anfrage

RIGATA CON BORDO ARROTONDATO E MARCATURA DI SICUREZZA RIBBED TILE WITH ROUNDED EDGE AND SECURITY MARKING
 CARREAU STRIE AVEC BORD ARRONDI ET MARQUAGE DE SECURITE RILLENPLATTE MIT GERUNDETE KANTE UND SICHERHEITSMARKIERUNG

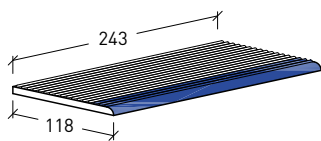

3346 Banda Blu

26 pc/box 0,50 kg/pc 4 pc/ml

LANDSCAPE - Rigata



100 Tundra

ELEMENTI - Rigata



010 Talco

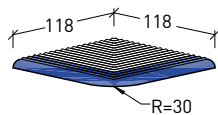

3349 Banda Blu

10 pc/box 0,25kg/pc

LANDSCAPE - Rigata



100 Tundra

ELEMENTI - Rigata



010 Talco

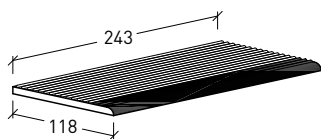

3346 Banda Nera

26 pc/box 0,50 kg/pc 4 pc/ml

LANDSCAPE - Rigata



100 Tundra

ELEMENTI - Rigata



010 Talco

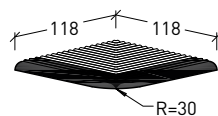

3349 Banda Nera

10 pc/box 0,25 kg/pc

LANDSCAPE - Rigata



100 Tundra

ELEMENTI - Rigata



010 Talco

PINHEAD CON BORDO ARROTONDATO E MARCATURA DI SICUREZZA PINHEAD WITH ROUNDED EDGE AND SECURITY MARKING
 PINHEAD AVEC BORD ARRONDI ET MARQUAGE DE SECURITE PINHEAD MIT GERUNDETE KANTE UND SICHERHEITSMARKIERUNG

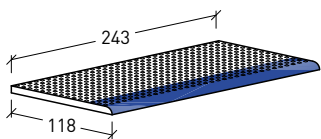

3356 Banda Blu

26 pc/box 0,50 kg/pc 4 pc/ml

ELEMENTI - Pinhead



010 Talco 011 Avorio

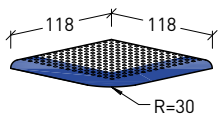

3359 Banda Blu

10 pc/box 0,25 kg/pc

ELEMENTI - Pinhead



010 Talco 011 Avorio

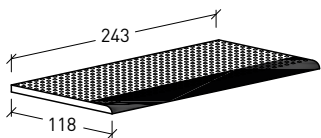

3356 Banda Nera

26 pc/box 0,50 kg/pc 4 pc/ml

ELEMENTI - Pinhead



010 Talco 060 Cemento

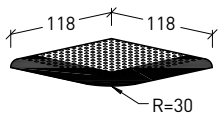

3359 Banda Nera

10 pc/box 0,25kg/pc

ELEMENTI - Pinhead



010 Talco 060 Cemento

ZOCOLO A RACCORDO SMUSSATO BEVELLED COVE BASE PLINTHE A GORGE CHANFREINE KEHLSOCKEL MIT SCHIEFER KANTE

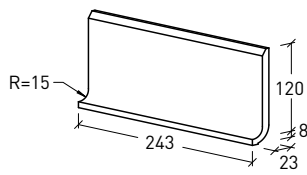
**4100**

26 pc/box 0,60 kg/pc 4 pc/ml

LANDSCAPE - Satin



100 Tundra

ELEMENTI - Matt*



010 Talco

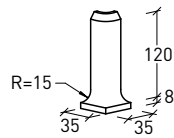

060 Cemento

**4127**

10 pc/box 0,10 kg/pc

LANDSCAPE - Satin



100 Tundra

ELEMENTI - Matt*



010 Talco

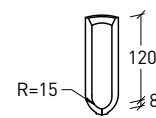

060 Cemento

**4128**

10 pc/box 0,10 kg/pc

LANDSCAPE - Satin



100 Tundra

ELEMENTI - Matt*



010 Talco



060 Cemento

ZOCOLO A RACCORDO TAGLIO RETTO COVE BASE STRAIGHT TOP PLINTHE A GORGE BORD DROIT KEHLSOCKEL SCHARFKANTIG

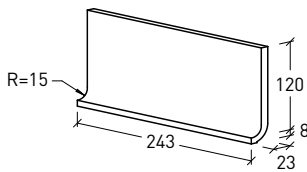
**4200**

26 pc/box 0,60 kg/pc 4 pc/ml

LANDSCAPE - Satin

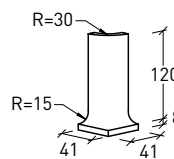

100 Tundra

**4227**

10 pc/box 0,10 kg/pc

LANDSCAPE - Satin

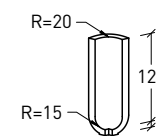

100 Tundra

**4228**

10 pc/box 0,10 kg/pc

LANDSCAPE - Satin



100 Tundra

* Colore 070 Ebano su richiesta Colour 070 Ebano on request Coloris 070 Ebano sur demande Farbe 070 Ebano auf Anfrage



CANALETTA PIANA CP001 E SCARICO A QUATTRO PENDENZE ANTISCIVOLO NON-SLIP FLAT CHANNEL CP001 AND INDEPENDENT WATER OUTLET CANIVEAU PLAT CP001 ET CUNETTE DE'ECOULEMENT ANTIDERAPANTS NON-SLIP FLACHRINNE CP001 UND FREIES WASSERABLAUF

Vedi pagina: See page: Voir page: Siehe Seite: **61**

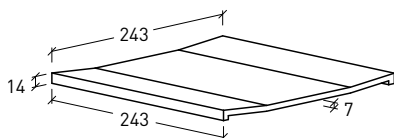

4500

Padana-Deck 8 pc/box 1,10 kg/pc 4 pc/ml

ELEMENTI - Grip*



010 Talco



060 Cemento

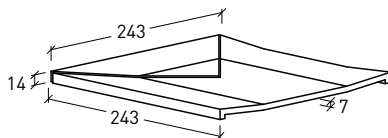

4503

Padana-Deck 8+8 pc/box 1,10 kg/pc

ELEMENTI - Grip*



010 Talco



060 Cemento

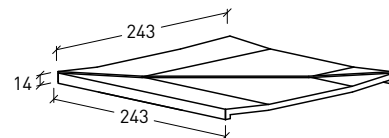

4508

Padana-Deck 2 pc 45° 8+8 pc/box 1,10 kg/pc

ELEMENTI - Grip*



010 Talco



060 Cemento

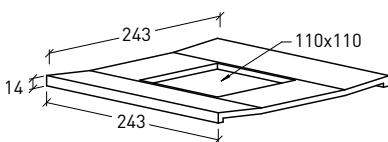

4509

Padana-Deck 8 pc/box 1,00 kg/pc

ELEMENTI - Grip*



010 Talco



060 Cemento

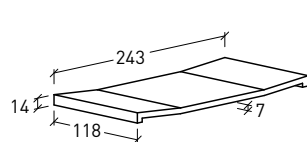

4520

Padana-Deck 16 pc/box 0,60 kg/pc 8 pc/ml

ELEMENTI - Grip*



010 Talco



060 Cemento

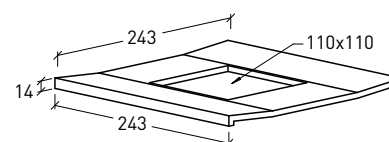

4609

Padana-Deck 8 pc/box 1,00 kg/pc

ELEMENTI - Grip*



010 Talco



060 Cemento

* Colori 021 Mare e 070 Ebano solo su richiesta
Colours 021 Mare and 070 Ebano on request only
Coloris 021 Mare et 070 Ebano uniquement sur demande
Farben 021 Mare und 070 Ebano nur Auf Anfrage

CANALETTE CON GRIGLIE DI COPERTURA CP002 CHANNELS WITH GRATINGS CP002 CANIVEAUX AVEC GRILLES CP002 RINNEN MIT ABDECKROSTE CP002

Vedi pagina: See page: Voir page: Siehe Seite: **62**

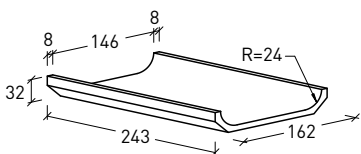

4700

Padana-Deck 10 pc/box 0,80 kg/pc 4 pc/ml

LANDSCAPE - Satin



100 Tundra

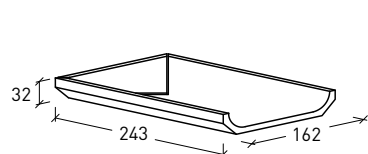

4703

Padana-Deck 5+5 pc/box 0,80 kg/pc

LANDSCAPE - Satin



100 Tundra

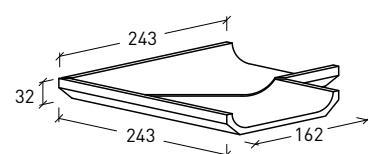

4708

Padana-Deck 2 pc 45° 5+5 pc/box 1,40 kg/pc

LANDSCAPE - Satin



100 Tundra

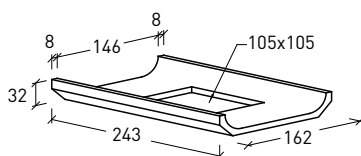

4709

Padana-Deck 10 pc/box 0,70 kg/pc

LANDSCAPE - Satin



100 Tundra

COPRI SPIGOLI QUARTER ROUNDS QUARTS DE ROND RADIALLEISTEN

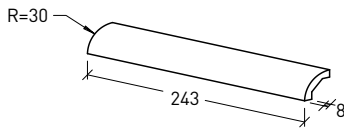
**5630**

48 pc/box 0,20 kg/pc 4 pc/ml

LANDSCAPE - Satin



100 Tundra 200 Bay 202 Ocean



700 Lava

LANDSCAPE - Grip



100 Tundra 202 Ocean 700 Lava

ELEMENTI - Matt



010 Talco 011 Avorio 060 Cemento

**5607**

10 pc/box 0,05 kg/pc

LANDSCAPE - Satin



100 Tundra 202 Ocean 700 Lava

LANDSCAPE - Grip



100 Tundra 202 Ocean 700 Lava

ELEMENTI - Matt

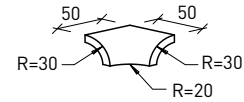

010 Talco 011 Avorio 060 Cemento

**5608**

10 pc/box 0,06 kg/pc

LANDSCAPE - Satin



100 Tundra 202 Ocean 700 Lava

ELEMENTI - Matt



010 Talco 011 Avorio 060 Cemento

SGUSCIETTE COVES GORGES HOHLKEHLEN

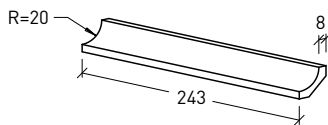
**5730**

48 pc/box 0,20 kg/pc 4 pc/ml

LANDSCAPE - Satin



100 Tundra 200 Bay 202 Ocean



700 Lava

ELEMENTI - Matt



010 Talco 011 Avorio 060 Cemento

**5603**

10 pc/box 0,05 kg/pc

LANDSCAPE - Satin



100 Tundra 202 Ocean 700 Lava

ELEMENTI - Matt

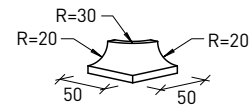

010 Talco 011 Avorio 060 Cemento

**5604**

10 pc/box 0,06 kg/pc

LANDSCAPE - Satin



100 Tundra 202 Ocean 700 Lava

ELEMENTI - Matt



010 Talco 011 Avorio 060 Cemento

BORDO WIESBADEN A PARETE E BORDO SKIMMER WIESBADEN LOW-LEVEL AND SKIMMER
PIÈCE DE BORDURE WIESBADEN EN PAROI ET SKIMMER BECKENRANDSTEIN WIESBADEN TIEFLIEGEND UND SKIMMER

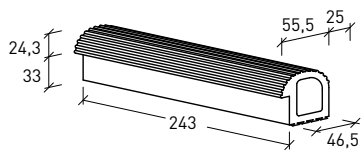

6050

Trim-Box 8 pc/box 0,80 kg/pc 4 pc/ml

LANDSCAPE - Rigata**



202 Ocean

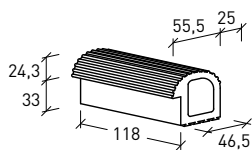

6020

Trim-Box 16 pc/box 0,40 kg/pc 8 pc/ml

LANDSCAPE - Rigata**



202 Ocean

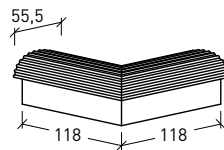

6057

Trim-Box 2 pc 45° 4+4 pc/box 0,80 kg/pc

LANDSCAPE - Rigata**



202 Ocean

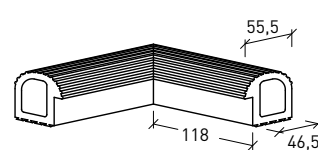

6058

Trim-Box 2 pc 45° 4+4 pc/box 0,80 kg/pc

LANDSCAPE - Rigata**



202 Ocean

P104-0242

Polyfill profilo / profile / profil / Profil

(1 pc)*

P105-0117

Polyfill profilo / profile / profil / Profil

(1 pc)*

* Vedi pagina: See page: Voir page: Siehe Seite: 36

** Colore 010 Talco su richiesta Colour 010 Talco on request Coloris 010 Talco sur demande Farbe 010 Talco auf Anfrage

SUPPORTO BETONBUILD PER WIESBADEN A PARETE CEMENTITIOUS SUPPORT BETONBUILD FOR WIESBADEN LOW-LEVEL
SUPPORT EN BETON BETONBUILD POUR WIESBADEN EN PAROI TRÄGERELEMENT BETONBUILD FÜR WIESBADEN TIEFLIEGEND

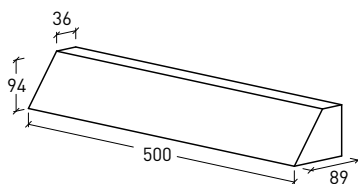

6315

Betonbuild 12,00 kg/pc 2 pc/ml

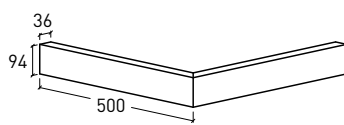

6317

Betonbuild 2 pc 45° 24,00 kg/pc

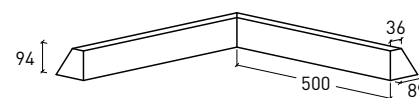

6318

Betonbuild 2 pc 45° 24,00 kg/pc

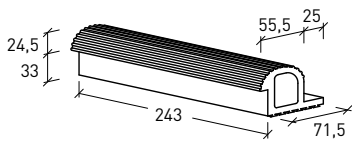

BORDO WIESBADEN A PAVIMENTO POOL BORDER WIESBADEN HIGH-LEVEL PIÈCE DE BORDURE WIESBADEN SURFLTOT
BECKENRANDSTEIN WIESBADEN HOCHLIEGEND

**6550**

Trim-Box 8 pc/box 0,80 kg/pc 4 pc/ml

LANDSCAPE - Rigata**

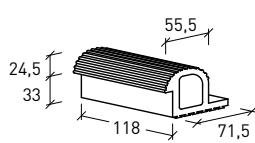

202 Ocean

**6520**

Trim-Box 16 pc/box 0,40 kg/pc 8 pc/ml

LANDSCAPE - Rigata**

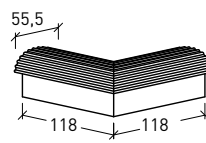

202 Ocean

**6557**

Trim-Box 2 pc 45° 4+4 pc/box 0,80 kg/pc

LANDSCAPE - Rigata**

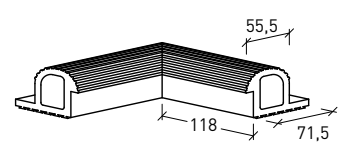

202 Ocean

**6558**

Trim-Box 2 pc 45° 4+4 pc/box 0,80 kg/pc

LANDSCAPE - Rigata**



202 Ocean

P104-0242

Polyfill profilo / profile / profil / Profil

(1 pc)*

P105-0117

Polyfill profilo / profile / profil / Profil

(1 pc)*

* Vedi pagina: See page: Voir page: Siehe Seite: 36

** Colore 010 Talco su richiesta Colour 010 Talco on request Coloris 010 Talco sur demande Farbe 010 Talco auf Anfrage

SUPPORTO BETONBUILD PER WIESBADEN A PAVIMENTO CEMENTITIOUS SUPPORT BETONBUILD FOR WIESBADEN HIGH-LEVEL
SUPPORT EN BETON BETONBUILD POUR WIESBADEN SURFLTOT TRÄGERELEMENT BETONBUILD FÜR WIESBADEN HOCHLIEGEND

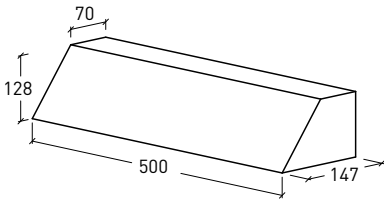
**6415**

Betonbuild 16,00 kg/pc 2 pc/ml

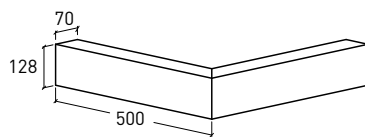
**6417**

Betonbuild 2 pc 45° 32,00 kg/pc

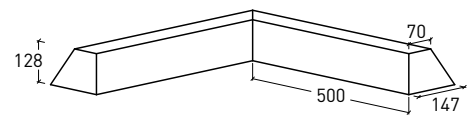
**6418**

Betonbuild 2 pc 45° 32,00 kg/pc



BORDO FINLANDESE RIGATA FINNISH POOL BORDER RIBBED TETE DE BASSIN FINLANDAISE STRIEE BECKENKOPF FINNLAND MIT RILLEN

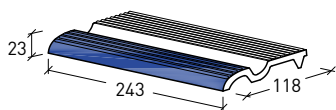

7200 Banda Blu

10 pc/box 0,90 kg/pc 4 pc/ml

LANDSCAPE - Rigata



100 Tundra

ELEMENTI - Rigata



010 Talco

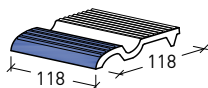

7220 Banda Blu

20 pc/box 0,45 kg/pc 8 pc/ml

LANDSCAPE - Rigata



100 Tundra

ELEMENTI - Rigata



010 Talco

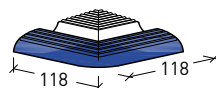

7207 Banda Blu

2 pc 45° 4+4 pc/box 0,40 kg/pc

LANDSCAPE - Rigata



100 Tundra

ELEMENTI - Rigata



010 Talco

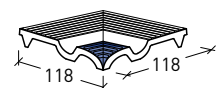

7208 Banda Blu

2 pc 45° 4+4 pc/box 0,40 kg/pc

LANDSCAPE - Rigata



100 Tundra

ELEMENTI - Rigata



010 Talco

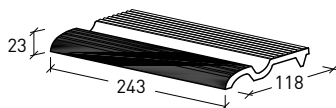

7200 Banda Nera

10 pc/box 0,90 kg/pc 4 pc/ml

LANDSCAPE - Rigata



100 Tundra

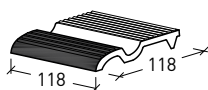

7220 Banda Nera

20 pc/box 0,45 kg/pc 8 pc/ml

LANDSCAPE - Rigata



100 Tundra

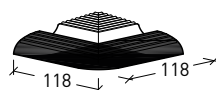

7207 Banda Nera

2 pc 45° 4+4 pc/box 0,40 kg/pc

LANDSCAPE - Rigata



100 Tundra

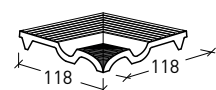

7208 Banda Nera

2 pc 45° 4+4 pc/box 0,40 kg/pc

LANDSCAPE - Rigata



100 Tundra

BORDO FINLANDESE PINHEAD FINNISH POOL BORDER PINHEAD TETE DE BASSIN FINLANDAISE PINHEAD BECKENKOPF FINNLAND PINHEAD

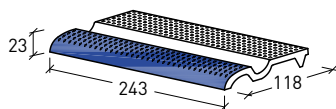

7300 Banda Blu

10 pc/box 0,90 kg/pc 4 pc/ml

ELEMENTI - Pinhead



010 Talco



011 Avorio

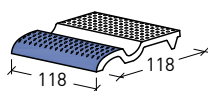

7320 Banda Blu

20 pc/box 0,45 kg/pc 8 pc/ml

ELEMENTI - Pinhead



010 Talco



011 Avorio

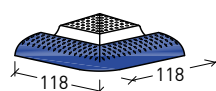

7307 Banda Blu

2 pc 45° 4+4 pc/box 0,40 kg/pc

ELEMENTI - Pinhead



010 Talco



011 Avorio

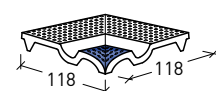

7308 Banda Blu

2 pc 45° 4+4 pc/box 0,40 kg/pc

ELEMENTI - Pinhead



010 Talco



011 Avorio

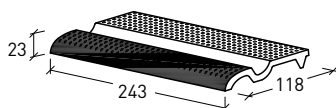

7300 Banda Nera

10 pc/box 0,90 kg/pc 4 pc/ml

ELEMENTI - Pinhead



010 Talco



060 Cemento

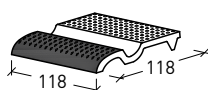

7320 Banda Nera

20 pc/box 0,45 kg/pc 8 pc/ml

ELEMENTI - Pinhead



010 Talco



060 Cemento

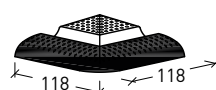

7307 Banda Nera

2 pc 45° 4+4 pc/box 0,40 kg/pc

ELEMENTI - Pinhead



010 Talco



060 Cemento



7308 Banda Nera

2 pc 45° 4+4 pc/box 0,40 kg/pc

ELEMENTI - Pinhead



010 Talco



060 Cemento

BORDO FINLANDESE TRIM-BOX CON AGGRAPPO E BANDA DI SICUREZZA FINNISH POOL BORDER TRIM-BOX WITH FINGER GRIP AND SECURITY MARKING
PIÈCE DE BORDURE FINLANDAISE TRIM-BOX AVEC ACCROCHE DOIGTS ET BANDE DE SÉCURITÉ BECKENRANDSTEIN FINNLAND TRIM-BOX MIT HANDFASS UND SICHERHEITSMARKIERUNG

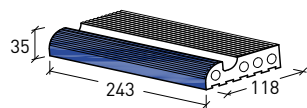
**7500 Banda Blu**

Trim-Box 6 pc/box 1,60 kg/pc 4 pc/ml

LANDSCAPE - Rigata**

100 Tundra

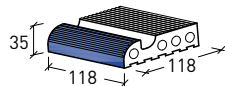
**7520 Banda Blu**

Trim-Box 12 pc/box 0,80 kg/pc 8 pc/ml

LANDSCAPE - Rigata**

100 Tundra

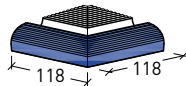
**7507 Banda Blu**

Trim-Box 2 pc 45° 6+6 pc/box 0,80 kg/pc

LANDSCAPE - Rigata**

100 Tundra

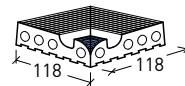
**7508 Banda Blu**

Trim-Box 2 pc 45° 6+6 pc/box 0,80 kg/pc

LANDSCAPE - Rigata**

100 Tundra

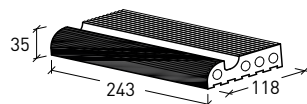
P106-0242Polyfill cilindro / cylinder / cilindre / Zylinder
(4 pcs)***P107-0117**Polyfill cilindro / cylinder / cilindre / Zylinder
(4 pcs)***7500 Banda Nera**

Trim-Box 6 pc/box 1,60 kg/pc 4 pc/ml

LANDSCAPE - Rigata**

100 Tundra

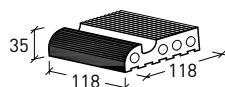
**7520 Banda Nera**

Trim-Box 12 pc/box 0,80 kg/pc 8 pc/ml

LANDSCAPE - Rigata**

100 Tundra

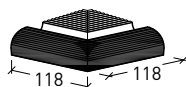
**7507 Banda Nera**

Trim-Box 2 pc 45° 6+6 pc/box 0,80 kg/pc

LANDSCAPE - Rigata**

100 Tundra

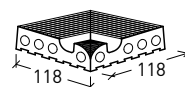
**7508 Banda Nera**

Trim-Box 2 pc 45° 6+6 pc/box 0,80 kg/pc

LANDSCAPE - Rigata**

100 Tundra

P106-0242Polyfill cilindro / cylinder / cilindre / Zylinder
(4 pcs)***P107-0117**Polyfill cilindro / cylinder / cilindre / Zylinder
(4 pcs)*

BORDO FINLANDESE TRIM-BOX CON AGGRAPPO, BANDA DI SICUREZZA E SUPPORTO GRIGLIA FINNISH POOL BORDER TRIM-BOX WITH FINGER GRIP, SECURITY MARKING AND SUPPORT FOR GRATING PIÈCE DE BORDURE FINLANDAISE TRIM-BOX AVEC ACCROCHE DOIGTS, BANDE DE SÉCURITÉ ET SUPPORT DE GRILLE BECKENRANDSTEIN FINNLAND TRIM-BOX MIT HANDFASS, SICHERHEITSMARKIERUNG UND ROSTTRÄGER

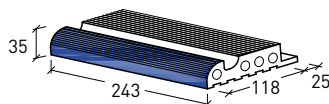
**7800 Banda Blu**

Trim-Box 7 pc/box 1,80kg/pc 4 pc/ml

LANDSCAPE - Rigata**

100 Tundra

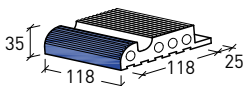
**7820 Banda Blu**

Trim-Box 14 pc/box 0,90 kg/pc 8 pc/ml

LANDSCAPE - Rigata**

100 Tundra

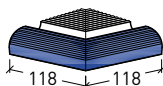
**7807 Banda Blu**

Trim-Box 2 pc 45° 7+7 pc/box 0,90kg/pc

LANDSCAPE - Rigata**

100 Tundra

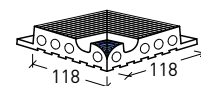
**7808 Banda Blu**

Trim-Box 2 pc 45° 7+7 pc/box 0,90kg/pc

LANDSCAPE - Rigata**

100 Tundra

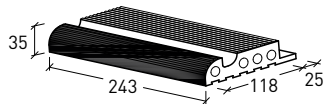
P106-0242Polyfill cilindro / cylinder / cilindre / Zylinder
(4 pcs)***P107-0117**Polyfill cilindro / cylinder / cilindre / Zylinder
(4 pcs)***7800 Banda Nera**

Trim-Box 7 pc/box 1,80kg/pc 4 pc/ml

LANDSCAPE - Rigata**

100 Tundra

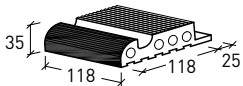
**7820 Banda Nera**

Trim-Box 14 pc/box 0,90 kg/pc 8 pc/ml

LANDSCAPE - Rigata**

100 Tundra

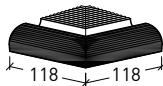
**7807 Banda Nera**

Trim-Box 2 pc 45° 7+7 pc/box 0,90kg/pc

LANDSCAPE - Rigata**

100 Tundra

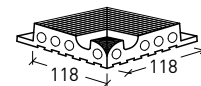
**7808 Banda Nera**

Trim-Box 2 pc 45° 7+7 pc/box 0,90kg/pc

LANDSCAPE - Rigata**

100 Tundra

P106-0242Polyfill cilindro / cylinder / cilindre / Zylinder
(4 pcs)***P107-0117**Polyfill cilindro / cylinder / cilindre / Zylinder
(4 pcs)*

* Vedi pagina: See page: Voir page: Siehe Seite: 36

** Colore 010 Talco su richiesta Colour 010 Talco on request Coloris 010 Talco sur demande Farbe 010 Talco auf Anfrage

BORDO FINLANDESE TRIM-BOX: PEZZO DI RACCORDO FINNISH POOL BORDER TRIM-BOX: CONNECTION PIECE TETE DE BASSIN FINLANDAISE TRIM-BOX: PIÈCE DE RACCORD BECKENKOPF FINNLAND TRIM-BOX: FORTFUEHRUNGSTUECK

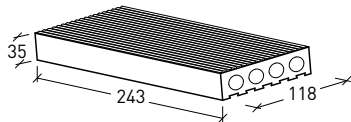

8100

Trim-Box 6 pc/box 1,60 kg/pc 4 pc/ml

LANDSCAPE - Rigata**



100 Tundra

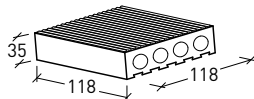

8120

Trim-Box 12 pc/box 0,80 kg/pc 8 pc/ml

LANDSCAPE - Rigata**



100 Tundra

P102-0242

Polyfill cilindro / cylinder / cilindre / Zylinder

(4 pcs)*

P103-0117

Polyfill cilindro / cylinder / cilindre / Zylinder

(4 pcs)*

BORDO FINLANDESE TRIM-BOX: PEZZO DI RACCORDO CON SUPPORTO GRIGLIA FINNISH POOL BORDER TRIM-BOX: CONNECTION PIECE WITH GRID SUPPORT TETE DE BASSIN FINLANDAISE TRIM-BOX: PIÈCE DE RACCORD AVEC SUPPORT DE GRILLE BECKENKOPF FINNLAND TRIM-BOX: FORTFUEHRUNGSTUECK MIT ROSTAUFLAGEWINKEL

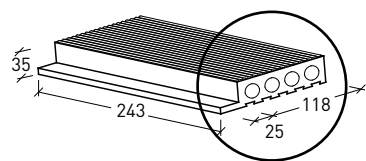

8600

Trim-Box 7 pc/box 1,80 kg/pc 4 pc/ml

LANDSCAPE - Rigata**



100 Tundra

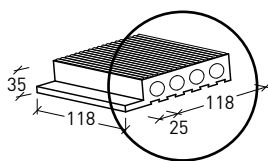

8620

Trim-Box 14 pc/box 0,90 kg/pc 8 pc/ml

LANDSCAPE - Rigata**



100 Tundra

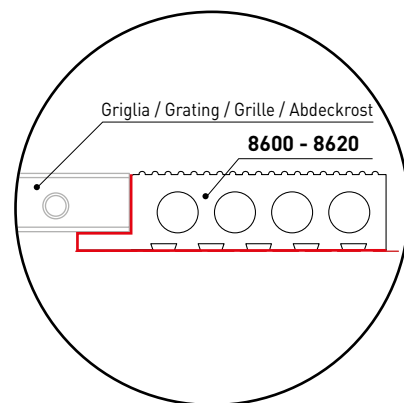

P102-0242

Polyfill cilindro / cylinder / cilindre / Zylinder

(4 pcs)*

P103-0117

Polyfill cilindro / cylinder / cilindre / Zylinder

(4 pcs)*

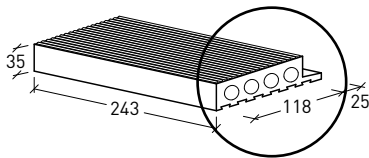

8800

Trim-Box 7 pc/box 1,80 kg/pc 4 pc/ml

LANDSCAPE - Rigata**



100 Tundra

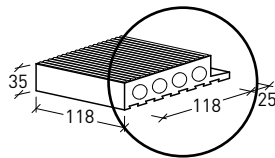

8820

Trim-Box 14 pc/box 0,90 kg/pc 8 pc/ml

LANDSCAPE - Rigata**



100 Tundra

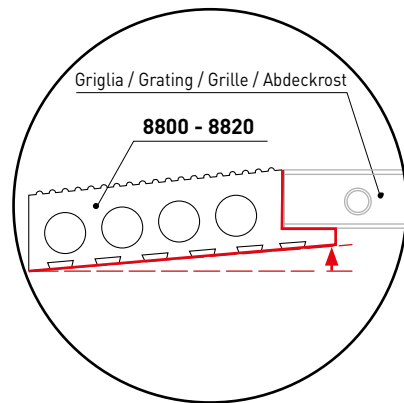

P102-0242

Polyfill cilindro / cylinder / cilindre / Zylinder

(4 pcs)*

P103-0117

Polyfill cilindro / cylinder / cilindre / Zylinder

(4 pcs)*

* Vedi pagina: See page: Voir page: Siehe Seite: 36

** Colore 010 Talco su richiesta Colour 010 Talco on request Coloris 010 Talco sur demande Farbe 010 Talco auf Anfrage

BORDO FINLANDESE TRIM-BOX: PEZZO ARROTONDATO "CON E SENZA SUPPORTO GRIGLIA" E "CON E SENZA MARCATURA DI SICUREZZA" FINNISH POOL BORDER TRIM-BOX: ROUNDED PIECE "WITH AND WITHOUT GRID SUPPORT" AND "WITH AND WITHOUT SECURITY MARKING" TETE DE BASSIN FINLANDAISE TRIM-BOX: PIÈCE ARRONDIE "AVEC ET SANS SUPPORT DE GRILLE" ET "AVEC ET SANS MARQUAGE DE SECURITÉ" BECKENKOPF FINNLAND TRIM-BOX: GERUNDETE STUECK "MIT UND OHNE ROSTAUFLAGEWINKEL" UND "MIT UND OHNE SICHEREITSMARKIERUNG"

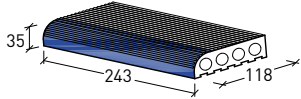
**9046 Banda Blu**

Trim-Box 6 pc/box 1,50 kg/pc 4 pc/ml

LANDSCAPE - Rigata**

100 Tundra

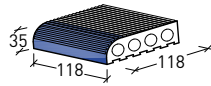
**9042 Banda Blu**

Trim-Box 12 pc/box 0,75 kg/pc 8 pc/ml

LANDSCAPE - Rigata**

100 Tundra

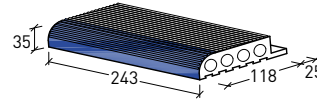
**9546 Banda Blu**

Trim-Box 7 pc/box 1,60 kg/pc 4 pc/ml

LANDSCAPE - Rigata**

100 Tundra

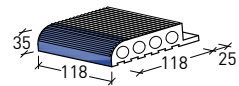
**9542 Banda Blu**

Trim-Box 14 pc/box 0,80 kg/pc 8 pc/ml

LANDSCAPE - Rigata**

100 Tundra

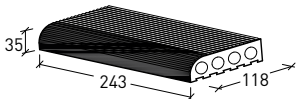
P102-0242Polyfill cilindro / cylinder / cilindre / Zylinder
(4 pcs)***P103-0117**Polyfill cilindro / cylinder / cilindre / Zylinder
(4 pcs)***P102-0242**Polyfill cilindro / cylinder / cilindre / Zylinder
(4 pcs)***P103-0117**Polyfill cilindro / cylinder / cilindre / Zylinder
(4 pcs)***9046 Banda Nera**

Trim-Box 6 pc/box 1,50 kg/pc 4 pc/ml

LANDSCAPE - Rigata**

100 Tundra

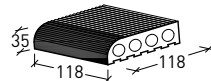
**9042 Banda Nera**

Trim-Box 12 pc/box 0,75 kg/pc 8 pc/ml

LANDSCAPE - Rigata**

100 Tundra

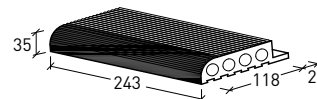
**9546 Banda Nera**

Trim-Box 7 pc/box 1,60 kg/pc 4 pc/ml

LANDSCAPE - Rigata**

100 Tundra

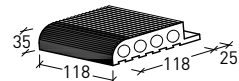
**9542 Banda Nera**

Trim-Box 14 pc/box 0,80 kg/pc 8 pc/ml

LANDSCAPE - Rigata**

100 Tundra

P102-0242Polyfill cilindro / cylinder / cilindre / Zylinder
(4 pcs)***P103-0117**Polyfill cilindro / cylinder / cilindre / Zylinder
(4 pcs)***P102-0242**Polyfill cilindro / cylinder / cilindre / Zylinder
(4 pcs)***P103-0117**Polyfill cilindro / cylinder / cilindre / Zylinder
(4 pcs)*

* Vedi pagina: See page: Voir page: Siehe Seite: 36

** Colore 010 Talco su richiesta Colour 010 Talco on request Coloris 010 Talco sur demande Farbe 010 Talco auf Anfrage



PIASTRELLE DI INDICAZIONE MARKING TILES CARREAUX NUMEROTES ANZEIGEFLEISEN

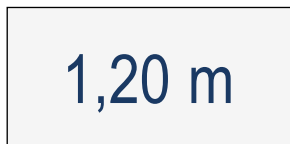

D400 100S
M12,5x25 cm
Tundra Satin - Ocean Satin



D400 200S
M12,5x25 cm
Bay Satin - Ocean Satin



D440 100S (2 pz)
M12,5x25 cm
Tundra Satin - Ocean Satin

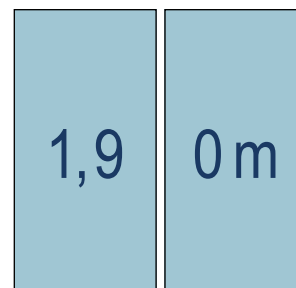

D440 200S (2 pz)
M12,5x25 cm
Bay Satin - Ocean Satin

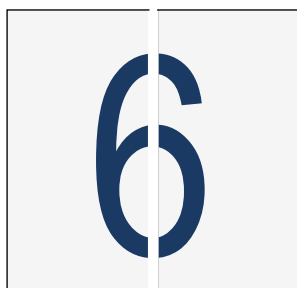

D480 100S (2 pz)
M12,5x25 cm
Tundra Satin - Ocean Satin

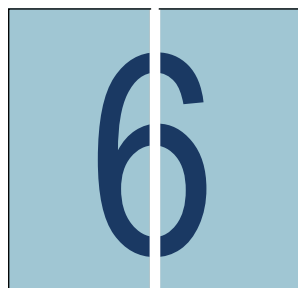

D480 200S (2 pz)
M12,5x25 cm
Bay Satin - Ocean Satin

DETTAGLI DETAILS DÉTAILS DETAILS

Carattere Arial Narrow

Font Arial Narrow - Caractère Arial Narrow - Schrifttyp Arial Narrow

Altezza carattere 7 cm

Font height 7 cm - Hauteur du caractère 7 cm - Schrifthöhe 7 cm

Spessore carattere 7 mm

Font width 7 mm - Dimension du caractère 7 mm - Schriftdicke 7 mm

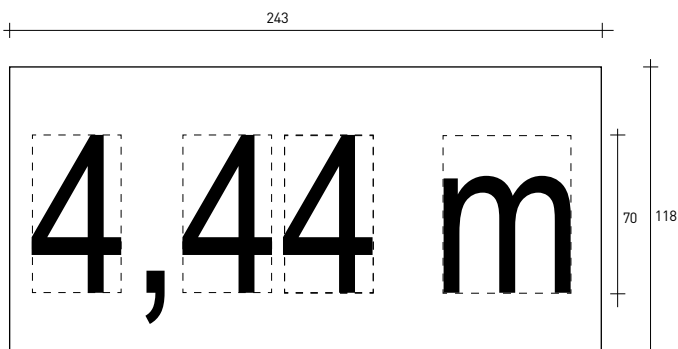

D400

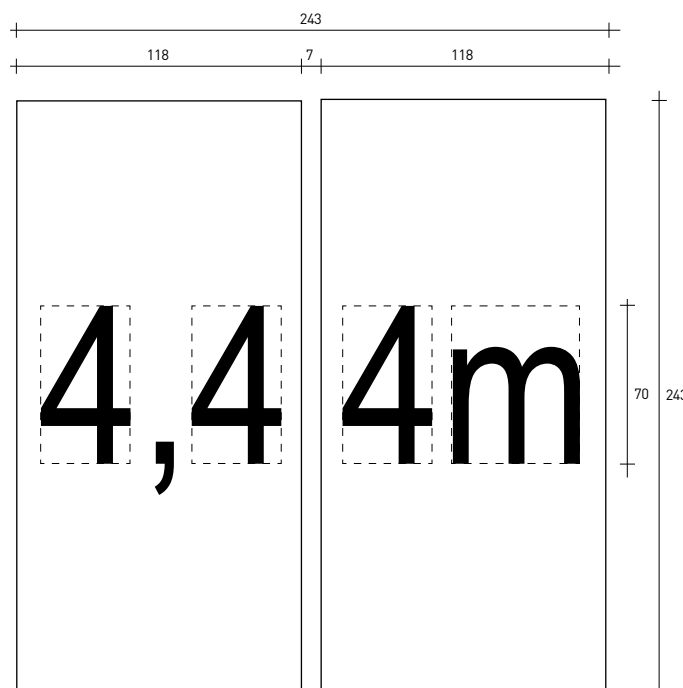

D440



Padana Grid griglie e accessori

GRATINGS AND ACCESSORIES
GRILLES ET ACCESSOIRES
ROSTE UND ZUBEHÖR

Il progetto di una piscina o impianto natatorio è estremamente complesso e la sua realizzazione vede spesso, accanto ai materiali ceramici, anche accessori di natura diversa che però devono essere installati contemporaneamente alla posa delle ceramiche.

E' proprio per dare un servizio completo e consentire la realizzazione integrale di taluni elementi costruttivi che è stata realizzata questa sezione dedicata agli accessori più standard utilizzati solitamente nelle piscine.

Designing a pool or swimming facility is a very complex activity and will most often include, next to ceramic materials, the use of other accessories of various nature, which might be installed simultaneously with the tiles.

This section has been specially dedicated to standard pool accessories in this respect and in order to provide a complete service while carrying out all the architectural elements.

Le projet d'une piscine ou d'une installation de natation est très complexe et sa réalisation prévoit très souvent le recours à des accessoires divers, à installer normalement lors de la pose de l'habillage céramique.

A cet égard et dans le but de fournir un service complet en mesure de réaliser l'ensemble des éléments architecturaux, la présente section a été spécialement conçue et dédiée aux accessoires standards pour piscines.

Das Projekt eines Schwimmbeckens oder einer Schwimmanlage ist äußerst komplex und seine Umsetzung erfordert oft, nebst den Keramikmaterialien, Zuberhörteile verschiedener Art, die jedoch gleichzeitig zur Verlegung der Keramik installiert werden müssen.

Zugunsten einer umfassenden Dienstleistung und für eine komplette Ausführung dieser Bauteile wurde dieser Bereich eingerichtet, der dem normalerweise in den Schwimmbädern verwendeten standardmäßigen Zubehör gewidmet ist.





GRIGLIE PER PISCINE GRATINGS FOR SWIMMING POOL GRILLES POUR PISCINES GRILLES POUR PISCINES

Sono realizzate in materiale plastico di prima qualità, non assorbenti, resistenti all'attacco degli agenti chimici, alla luce e ai raggi UV, con il necessario grado di antiscivolosità a piedi nudi e una distanza massima fra le singole stecche di 8 mm, come richiesto dalla norma EN 13451/3.

They are made with high-quality plastic, they are non-absorbent, chemical, light and UV resistant, with the necessary barefoot anti-slip grade and maximum distance between the rods equal to 8 mm, as defined in EN 13451/3.

Sont réalisées en matière plastique haut de gamme, non absorbantes, résistantes aux agents chimiques, à la lumière et aux rayons UV, avec classement antidérapant pieds nus et distance maximum entre les baguettes égale à 8 mm, au sens de la norme EN 13451/3.

Sie sind aus erstklassigem Kunststoffmaterial hergestellt, sind nicht saugfähig, sind beständig gegen Chemikalien, Licht und UV-Strahlen, weisen den erforderlichen Rutschfestigkeitskoeffizienten bei barfüßigem Betreten auf und haben einen Höchstabstand zwischen den einzelnen Stäben von 8 mm, entsprechend den Vorgaben der Norm EN 13451/3.

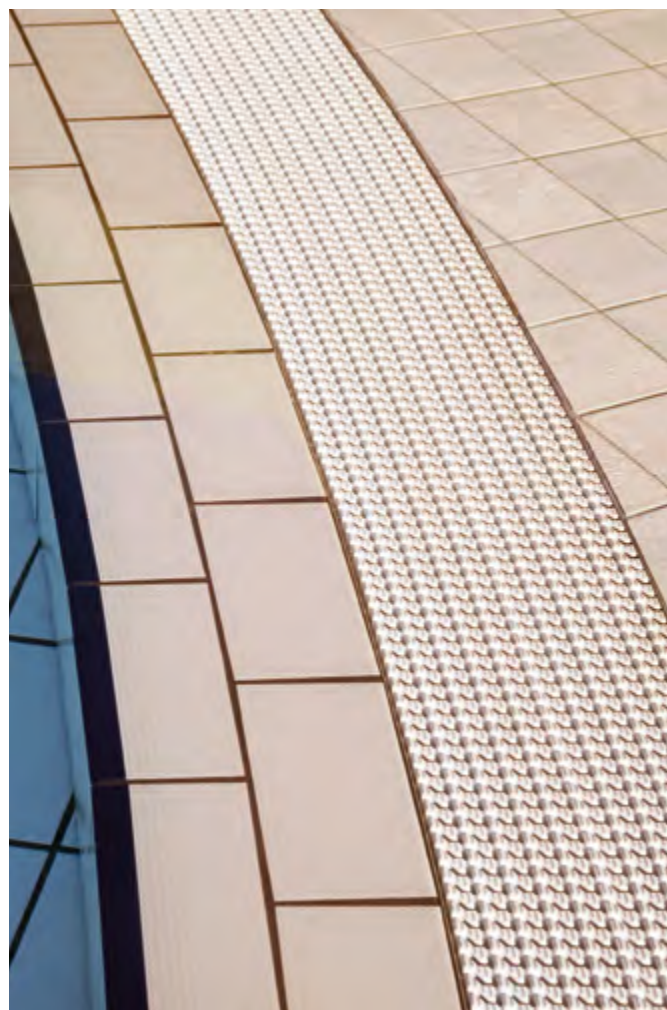
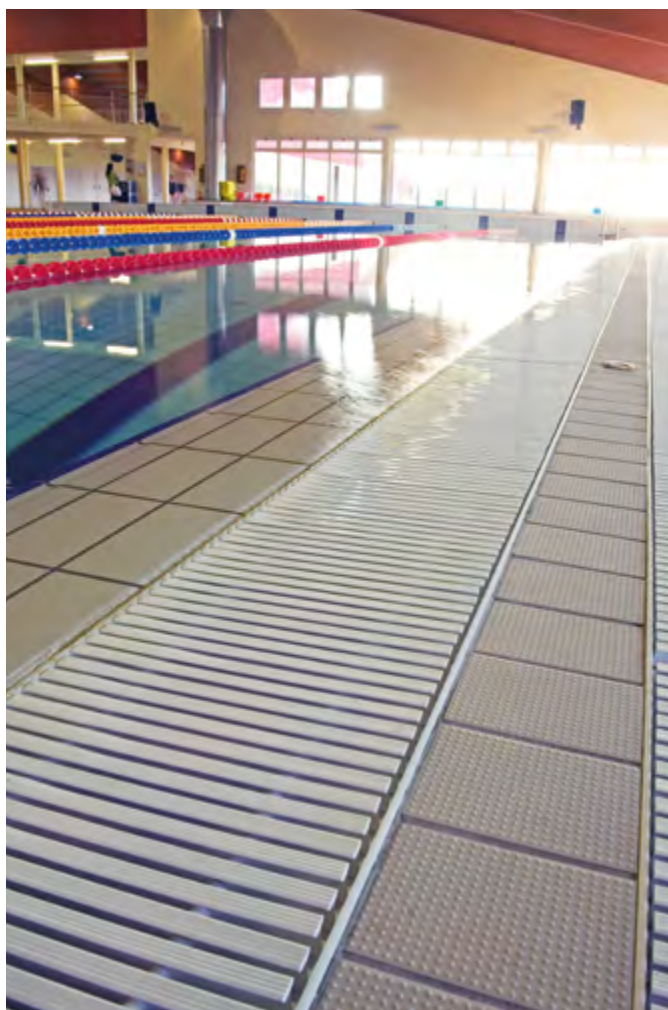

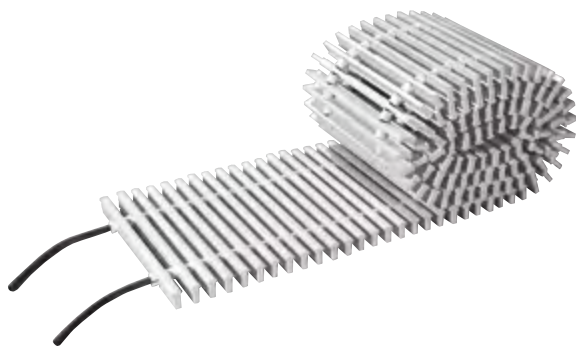

Mod. GPAL

Padana-Grid

Griglia perpendicolare, arrotolabile, lineare

Perpendicular roll-up linear gratings

Grille perpendiculaire, enroulable, linéaire

Rechtwinkliges, aufrollbares, lineares Abdeckrost

Codice griglia Item code Code grille Rostcode	Larghezza Width Largeur Rostbreite	Peso Weight Poids Gewicht	Spessore Thickness Epaisseur Stärke	Colore Colour Couleur Farbe
GPAL-180B	180 mm	3 kg	25 mm	Bianco (B) White (B) Blanc (B) Weiß (B)
GPAL-200B	200 mm	3,3 kg		
GPAL-250B	250 mm	4,1 kg		
GPAL-330B	330 mm	5,4 kg		

Larghezza minima 180 mm. Elementi standard 2,50 metri. Altri colori e larghezze a richiesta. A richiesta può essere fornita curvata a disegno. Minimum width 180 mm. Standard elements 2,50 meters. Other colours and widths on demand. On demand we can supply this model curved. Largeur minimale 180 mm. Elements standard 2,50 mètres. Autres largeurs et couleurs sur demande. Sur demande ce modèle est disponible curvée sur mesure. Minimale Breite 180 mm. Geliefert in Stücke von 2,50 Metern. Andere Breite und Farben auf Anfrage. Auf Anfrage dieses Modell kann gerundet geliefert sein.



Mod. GAPP

Padana-Grid

Angolo a 90° per griglie perpendicolari

Corner at 90° for perpendicular gratings

Angle à 90° pour grilles perpendiculaires

Ecke 90° für Rechtwinklige Abdeckroste

Codice griglia Item code Code grille Rostcode	Larghezza Width Largeur Rostbreite	Spessore Thickness Epaisseur Stärke	Colore Colour Couleur Farbe
GAPP-180B	180 mm	25 mm	Bianco (B) White (B) Blanc (B) Weiß (B)
GAPP-200B	200 mm		
GAPP-250B	250 mm		
GAPP-330B	330 mm		

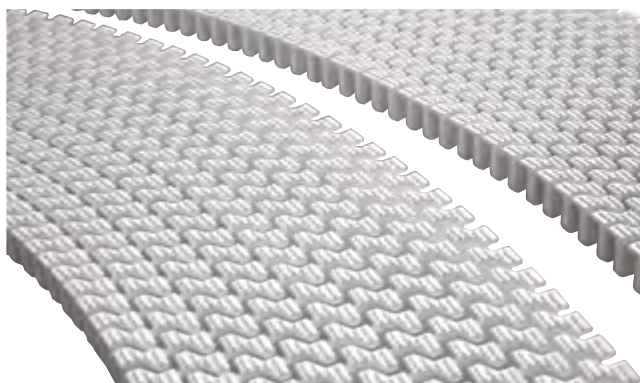

Mod. GPCB

Padana-Grid

Griglia perpendicolare, curvabile in polipropilene con barre ad incastro

Perpendicular bendable grating made of polypropylene with set-in bars

Grille perpendiculaire adaptable en polypropylène avec barreaux encastrés

Rechtwinkliges, biegbares Abdeckrost aus Polypropylen mit einklemmenden Elementen

Codice griglia Item code Code grille Rostcode	Larghezza Width Largeur Rostbreite	Peso ML Weight LM Poids ML Gewicht LM	Spessore Thickness Epaisseur Stärke	Colore Colour Couleur Farbe
GPCB-180B	180 mm	2,3 kg	25 mm	Bianco (B) White (B) Blanc (B) Weiß (B)
GPCB-200B	198 mm	2,4 kg		
GPCB-250B	248 mm	3,2 kg		
GPCB-300B	300 mm	4,0 kg		

Elementi standard 1,00 metro Standard elements 1,00 meter Elements standard 1,00 mètre
Geliefert in Stücke von 1,00 Meter

Altri colori a richiesta Other colours on demand Autres couleurs sur demande Andere Farben auf Anfrage

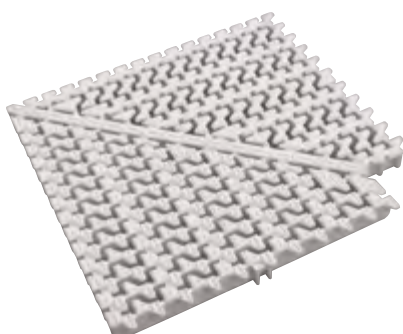

Mod. GACB

Padana-Grid

Angolo a 90° per griglia perpendicolare curvabile

Corner at 90° for perpendicular bendable grating

Angle a 90° pour grille perpendiculaire adaptable

Ecke 90° für rechtwinklige biegbare Abdeckrost

Codice griglia Item code Code grille Rostcode	Larghezza Width Largeur Rostbreite	Spessore Thickness Epaisseur Stärke	Colore Colour Couleur Farbe
GACB-180B	180 mm	25mm	Bianco (B) White (B) Blanc (B) Weiß (B)
GACB-250B	248 mm		



Mod. **GPRP**

Padana-Grid

Griglia parallela rigida stampata

Moulded parallel rigid grating

Grille parallèle rigide moulée

Gepresster paralleler steifer Abdeckrost

Codice griglia Item code Code grille Rostcode	Larghezza Width Largeur Rostbreite	Peso ML Weight LM Poids ML Gewicht LM	Spessore Thickness Epaisseur Stärke	Colore Colour Couleur Farbe
GPRP-182B	181 mm	1,8 kg	25 mm	Bianco (B) White (B) Blanc (B) Weiß (B)
GPRP-250B	245 mm	2,5 kg		
GPRP-330B	330 mm	3,3 kg		

Elementi standard 33,3 cm Standard elements 33,3 cm Elements standard 33,3 cm
Geliefert in Stücke von 33,3 cm

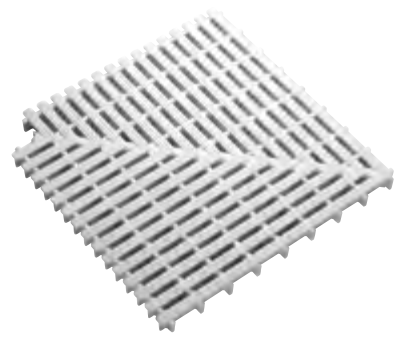

Mod. **GARS**

Padana-Grid

Angolo a 90° per griglia parallela stampata

Corner at 90° for moulded parallel grating

Angle a 90° pour grille parallèle moulée

Ecke 90° für gepresste parallele Abdeckrost

Codice griglia Item code Code grille Rostcode	Larghezza Width Largeur Rostbreite	Spessore Thickness Epaisseur Stärke	Colore Colour Couleur Farbe
GARS-182B	181 mm	25 mm	Bianco (B) White (B) Blanc (B) Weiß (B)
GARS-250B	245 mm		
GARS-330B	330 mm		



Mod. **GPAP**

Padana-Grid

Griglia parallela rigida assemblata

Assembled parallel rigid linear grating

Grille parallèle, rigide assemblée

Paralleles, zusammengefügt Abdeckrost

Codice griglia Item code Code grille Rostcode	Larghezza Width Largeur Rostbreite	Peso Weight Poids Gewicht	Spessore Thickness Epaisseur Stärke	Colore Colour Couleur Farbe
GPAP-150B	150 mm	2,5 kg	25 mm	Bianco (B) White (B) Blanc (B) Weiß (B)
GPAP-180B	180 mm	3,0 kg		
GPAP-200B	200 mm	3,3 kg		
GPAP-250B	250 mm	4,1 kg		
GPAP-330B	330 mm	5,4 kg		

Larghezza minima 150 mm. Elementi standard 1,00 metro Minimum width 150 mm. Standard elements 1,00 meter Largeur minimale 150 mm. Elements standard 1,00 mètre Minimale Breite 150 mm. Geliefert in Stücke von 1,00 Meter

Altri colori a richiesta Other colours on demand Autres couleurs sur demande Andere Farben auf Anfrage

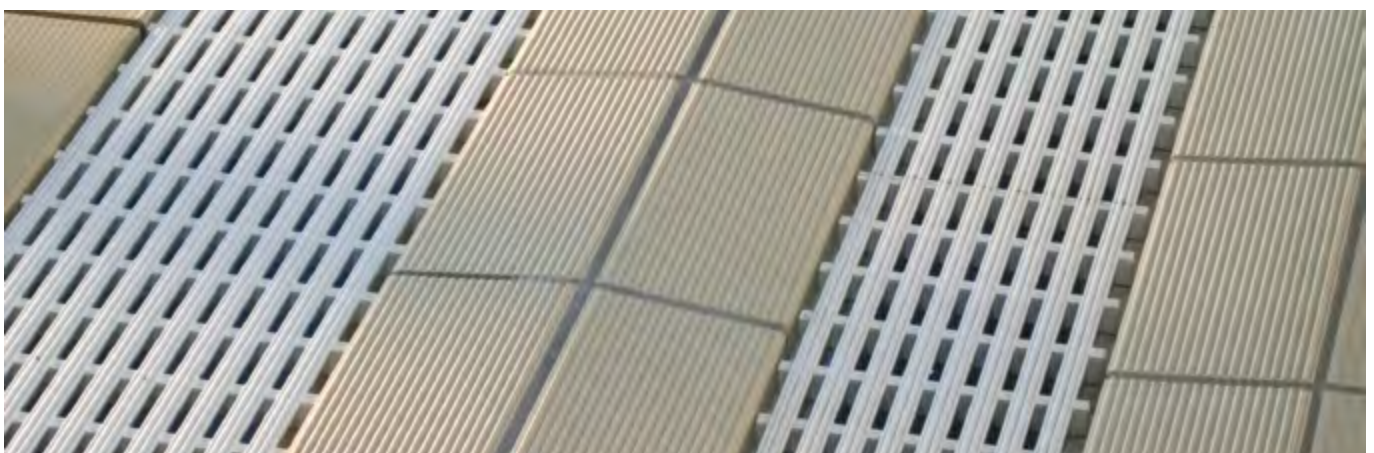

SUPPORTI GRIGLIA GRATING SUPPORTS SUPPORTS DE GRILLE ROSTTRÄGER

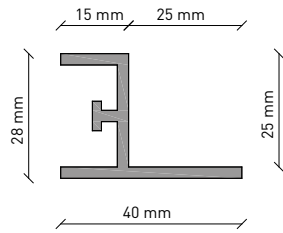
**SL25 PVCB***

Padana-Grid

Codice articolo Item code Code piece Artikel	Materiale Material Matériel Material	Colore Colour Couleur Farbe	Lunghezza Length Longueur Länge	Pezzi per fascio Pcs per bundle Piece par faisceau Stücke je Bündel	Peso ML Weight LM Poids ML Gewicht LM
SL25 PVCB	PVC	Bianco (B) White (B) Blanc (B) Weiß (B)	2,5 m	20 pcs	0,35 kg

* Conservare al riparo dalla luce solare ed a temperature <40°C Keep away from sunlight and store at temperatures <40°C
 Conserver à l'abri du rayonnement solaire et à des températures <40 °C Vor Sonnenlicht geschützt und bei Temperaturen <40°C lagern

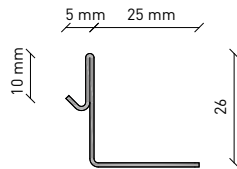
**SL25 IR16**

Padana-Grid

Codice articolo Item code Code piece Artikel	Materiale Material Matériel Material	Colore Colour Couleur Farbe	Lunghezza Length Longueur Länge	Pezzi per fascio Pcs per bundle Piece par faisceau Stücke je Bündel	Peso ML Weight LM Poids ML Gewicht LM
SL25 IR16	Acciaio inox * Stainless Steel * Acier inox * Edelstahl *	Lucido Polished Poli Glanzend	1,48 m	1 pc	1,0 kg

* AISI 316L – BA EN 1.4404

Classe di corrosività C4 Corrosion Class C4 Catégorie de corrosivité C4 Korrosionsklasse C4

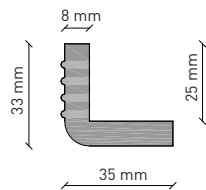
**0500 100S**

Padana-Grid

Codice articolo Item code Code piece Artikel	Materiale Material Matériel Material	Colore Colour Couleur Farbe	Lunghezza Length Longueur Länge	Pezzi per scatola Pcs per bundle Piece par faisceau Stücke je Bündel	Peso pezzo Weight PC Poids PC Gewicht PC
0500 100S	Ceramica Ceramic Céramique Keramik	Bianco 100 Tundra (smaltato) White 100 Tundra (glazed) Blanc 100 Tundra (émaillé) Weiß 100 Tundra (glasierte)	0,243 m	36 pcs	0,25 kg

ANCORAGGI IN ACCIAIO INOX PER CORSIE GALLEGGIANTI STAINLESS STEEL ANCHORS FOR FLOATING LANES
ANCRAGES EN ACIER INOX POUR COULOIRS FLOTTANTS VERANKERUNGEN AUS ROSTFREIEM STAHL FÜR SCHWIMMBAHNLEINEN

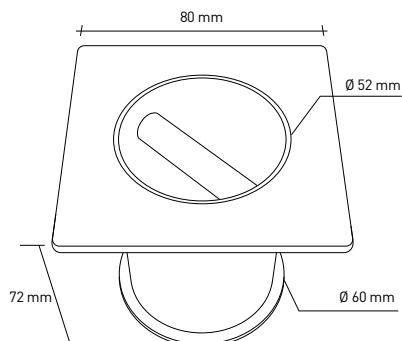

AANC 041A

Padana-Grid

Ancoraggio da parete (per cemento armato) realizzato in acciaio inossidabile AISI-316 da incassare sulle testate della vasca per il posizionamento delle corsie galleggianti.

Wall anchorage (for concrete) made of stainless steel AISI-316 to be set on headwalls of pool to fix floating lanes.

Ancrage de paroi (pour béton) en acier inoxydable AISI-316 à positionner sur le quai de départ pour fixer les couloirs flottants.

Wandverankerung (für Beton) aus rostfreiem Edelstahl AISI-316 zum einbetten in die Stirnwände für die Schwimmbahnleinen.

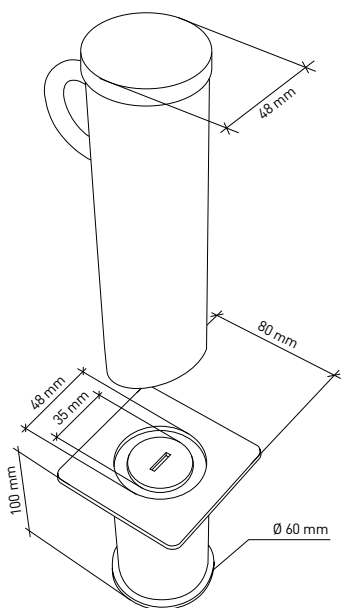

APAL 055A

Padana-Grid



AANC 051A

Padana-Grid

Ancoraggio da pavimento (per cemento armato) e paletto estraibile (art. APAL-055A) realizzati in acciaio inossidabile AISI-316 da incassare sul bordo vasca per il posizionamento delle corsie galleggianti.

La base di questo ancoraggio serve anche per fissare placche di virata, indicatori di virata e falsa partenza e scalette amovibili.

Pool deck anchor (for concrete) and removable post (Item APAL-055A) made of stainless steel AISI-316 to be set on pool deck to fix floating lanes. The same anchorage can be used to fix turning panels, false start and backstroke warning indicators as well as removable ladders.

Ancrage au sol (pour béton) et piquet amovible (Art. APAL-055A) en acier inoxydable AISI-316 à positionner sur la tête de bassin pour fixer les couloirs flottants. Le même ancrage peut être utilisé pour fixer les plaques de retour, les lignes de virage et faux départ et les échelles amovibles.

Bodenverankerung (für Beton) und ausziehbare Riegel (Art. APAL-055A) aus rostfreiem Edelstahl AISI-316 zum einbetten in dem Beckenumgang für die Schwimmbahnleinen. Die gleiche Verankerung kann man für Befestigung von Wendepfannen, Rückenwende und Fehlstartleinen sowie Beckensteigleitern verwenden.

**BOCCHETTE DI SCARICO PER CANALETTA DI VASCA WATER OUTLETS FOR SCUM CHANNEL
EVACUATIONS EAUX DE BASSIN WASSERABLAUF FÜR ÜBERFLUTUNGSRINNE**

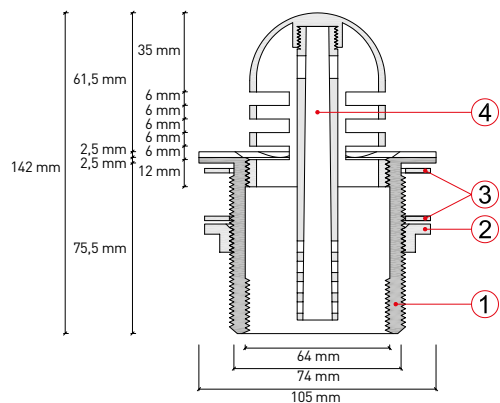

- 1 Base bocchetta Base of water outlet Base du siphon Basis Wasserablauf
- 2 Ghiera di bloccaggio Tightening screw Vis de serrage Spannschraube
- 3 Guarnizioni in plastica Plastic gaskets Joints en plastique Kunststoffdichtungen
- 4 Griglia di pre-filtraggio silenziosa Silent pre-filtering grating Grille de pre-filtrage silencieuse Geräuscharmes Vorfiltergitter

Bocchetta in materiale plastico ABS da 2,5" con scarico diametro 64 mm (capacità 120 litri/minuto), griglia di pre-filtraggio e sistema antigorgoglio.

Siphon en matériel plastique ABS de 2,5" avec évacuation de 64 mm de diamètre (débit 120 litres/minute), grille de pre-filtrage et système anti-bruit.



ASSV ABSG

Padana-Grid

ABS Plastic water outlets of 2,5" with drain pipe of 64 mm diameter (capacity 120 litres/minute), pre-filtering grid and anti-noise system.

Wasserabläufe aus Kuhnstoff ABS von 2,5" mit Ablauf von 64 mm (120 Liter/Minute), Vorfilter und Belüfter.

Padana Deck_Sport&Fun canalette per esterni vasca

CHANNELS FOR POOL DECKS
CANIVEAUX DE PLAGE
BECKENUMGANGSRINNEN

Le canalette sono necessarie in tutti gli ambienti piscina e servono a raccogliere l'acqua nelle aree intorno alle vasche; sia quella dispersa dall'attività natatoria degli utenti che quella necessaria al lavaggio dei pavimenti.

Un insieme di pezzi speciali e sistemi dedicati a questo tipo di finiture permette di recuperare l'acqua sia con sistemi puntuali sia creando canalizzazioni complete con e senza griglie di copertura.

The use of channels is necessary in all pools to collect water on pool deck; both the water scattered by the swimming activities and the one needed to wash the floors.

A line of fittings and systems designed specifically for this type of finish can be used to recover water through a system of channels with or without covering grating.

Le recours à des systèmes de caniveaux s'impose dans toutes les piscines pour récupérer l'eau que les baigneurs amènent sur les plages mais aussi les eaux de lavage des sols.

Une ligne de pièces spéciales et systèmes spécialement conçues pour ce type de finitions permet de récupérer l'eau moyennant un système de caniveaux sans ou avec grille de recouvrement.

Die Rinnen sind in allen Schwimmbadbereichen erforderlich und dienen der Sammlung des Wassers in den umgebenden Beckenumgängen; dabei wird sowohl das beim Schwimmen von den Badegästen verspritzte Wasser als auch das zur Fußbodenreinigung verwendete Wasser aufgesammelt.

Ein dieser Art der Endbearbeitungen gewidmeter Formteilsatz ermöglicht die Rückgewinnung des Wassers, sowohl mittels punktueller Systeme als auch anhand der Verlegung kompletter Kanalisierungen mit und ohne Abdeckroste.

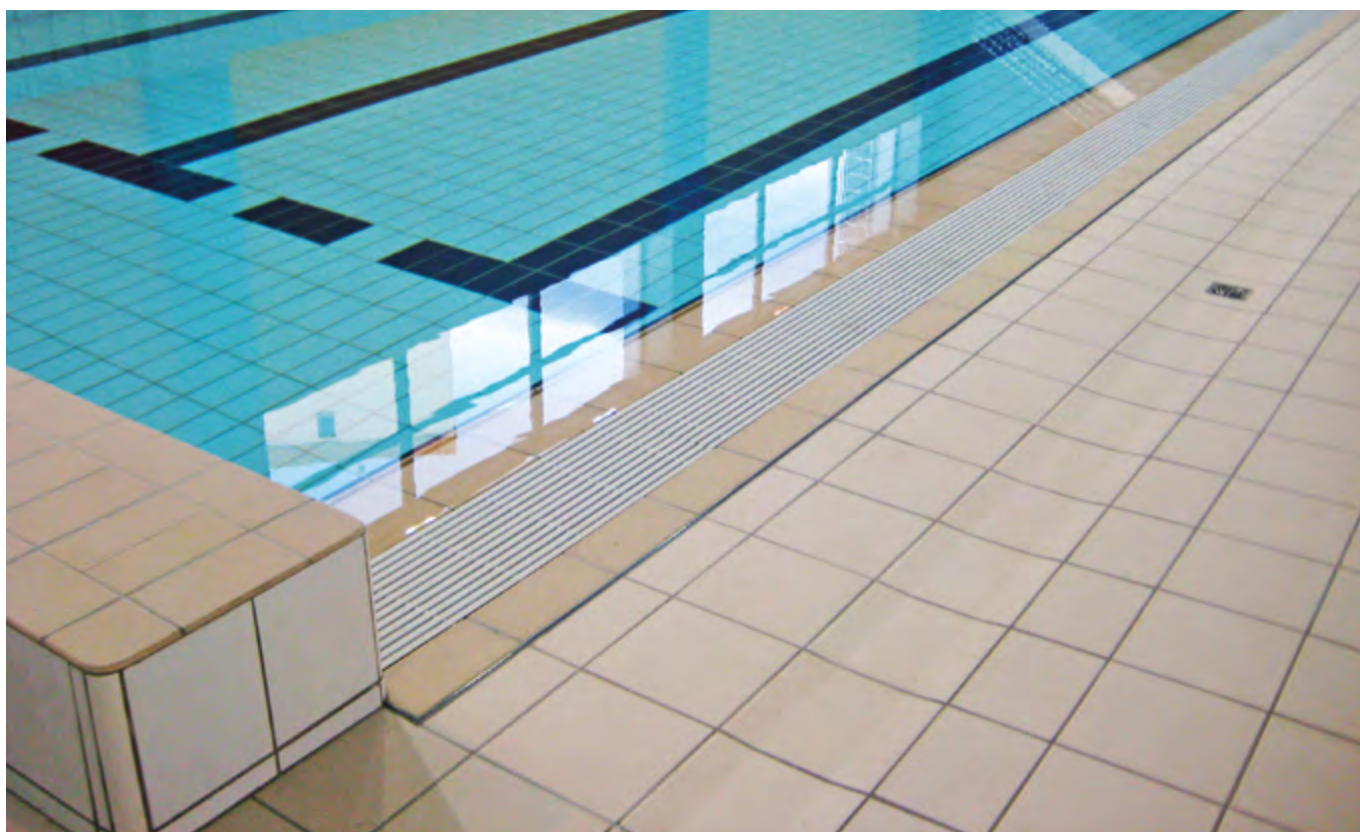

Mod.CP 001

CANALETTA PIANA E SCARICO A QUATTRO PENDENZE ANTISCIVOLO NON-SLIP FLAT CHANNEL AND INDEPENDENT WATER OUTLET
CANIVEAU PLAT ET CUNETTE DE'ECOLEMENT ANTIDERAPANTS NON-SLIP FLACHRINNE UND FREIES WASSERABLAUF

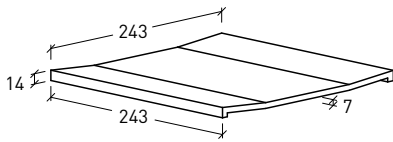
**4500**

Padana-Deck 8 pc/box 1,10 kg/pc 4 pc/ml

ELEMENTI - Grip*

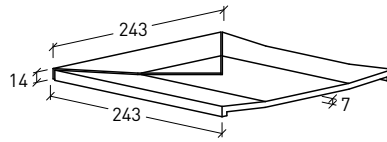

010 Talco 060 Cemento

**4503**

Padana-Deck 8+8 pc/box 01,10 kg/pc

ELEMENTI - Grip*

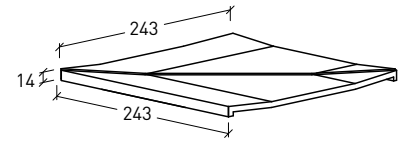

010 Talco 060 Cemento

**4508**

Padana-Deck 2 pc 45° 8+8 pc/box 1,10 kg/pc

ELEMENTI - Grip*

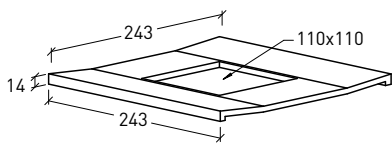

010 Talco 060 Cemento

**4509**

Padana-Deck 8 pc/box 1,00 kg/pc

ELEMENTI - Grip*

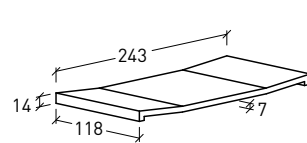

010 Talco 060 Cemento

**4520**

Padana-Deck 16 pc/box 0,60 kg/pc 8 pc/ml

ELEMENTI - Grip*

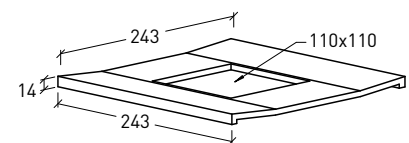

010 Talco 060 Cemento

**4609**

Padana-Deck 8 pc/box 1,00 kg/pc

ELEMENTI - Grip*



010 Talco 060 Cemento

* Colori 021 Mare e 070 Ebano solo su richiesta
 Colours 021 Mare and 070 Ebano on request only
 Coloris 021 Mare et 070 Ebano uniquement sur demande
 Farben 021 Mare und 070 Ebano nur Auf Anfrage

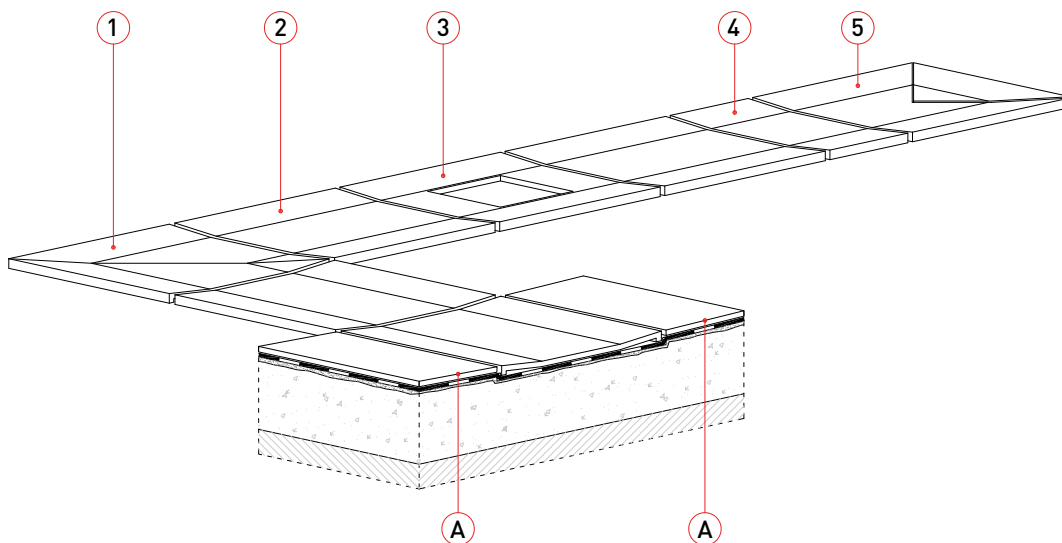

A piastrella spiaggia pool deck tile carreau de plage beckenumgang-fliese

Per le bocchette di scarico da applicare a questo sistema vedi pag. 65
 For the water outlets suitable to this system see pages 65
 Pour les siphons de ce système voir pages 65
 Für die Wasserabläufe dieses Systems siehe Seiten 65

Mod.CP 002

CANALETTE CON GRIGLIE DI COPERTURA CHANNELS WITH GRATINGS CANIVEAUX AVEC GRILLES RINNEN MIT ABDECKROSTE

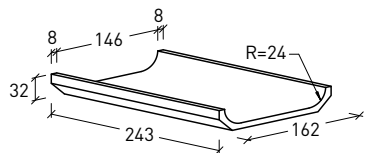

4700

Padana-Deck 10 pc/box 0,80 kg/pc 4 pc/ml

LANDSCAPE - Satin



100 Tundra

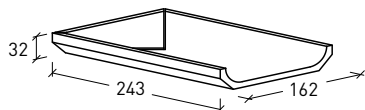

4703

Padana-Deck 5+5 pc/box 0,80 kg/pc

LANDSCAPE - Satin



100 Tundra

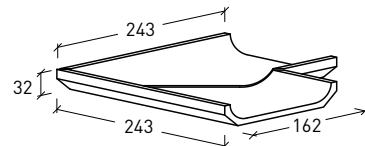

4708

Padana-Deck 2 pc 45° 5+5 pc/box 1,00 kg/pc

LANDSCAPE - Satin



100 Tundra

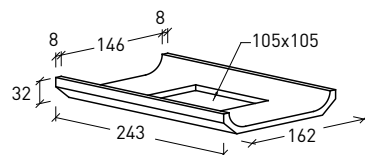

4709

Padana-Deck 10 pc/box 0,70 kg/pc

LANDSCAPE - Satin



100 Tundra

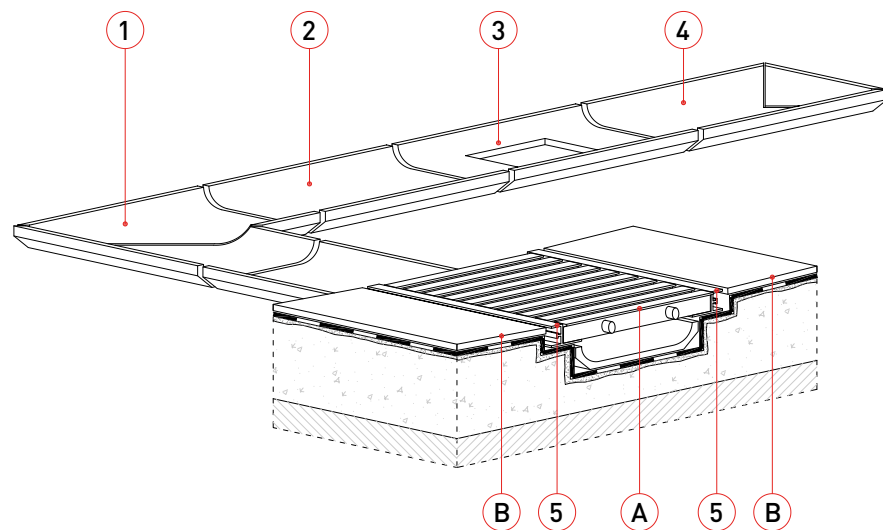

A griglia in pvc grating in pvc grille en pvc pvc rost

B piastrella spiaggia pool deck tile carreau de plage beckenumgang-fliese

Per le bocchette di scarico da applicare a questo sistema vedi pag. 65

For the water outlets suitable to this system see pages 65

Pour les siphons de ce système voir pages 65

Für die Wasserabläufe dieses Systems siehe Seiten 65



Mod.CP003-PVC

CANALETTE CON GRIGLIE DI COPERTURA CHANNELS WITH GRATINGS CANIVEAUX AVEC GRILLES RINNEN MIT ABDECKKROSTE

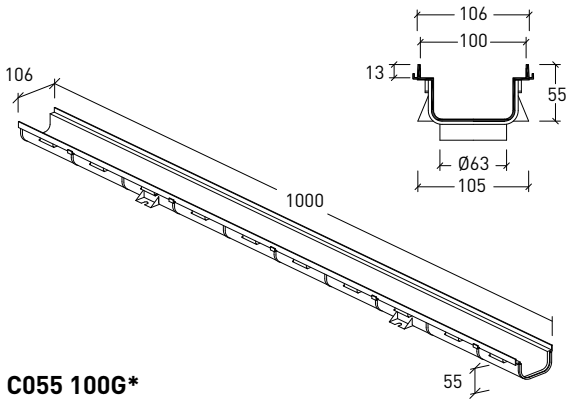

C055 100G*

Padana-Grid 12 pc/box 0,9 kg/pc

Canaletta in PVC con scarico verticale Ø 40 mm o Ø 63 mm **
 PVC channel with vertical outlet Ø 40 mm or Ø 63 mm
 Caniveau en PVC avec évacuation verticale Ø 40 mm ou Ø 63 mm
 PVC Rinne mit vertikalem Wasserablauf Ø 40 mm oder Ø 63 mm

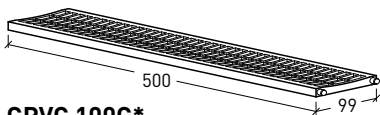

GPVC 100G*

Padana-Grid 1 pc/box 0,4 kg/pc

Griglia in Pvc / Pvc grating / Grille en Pvc / Rost aus Pvc

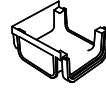

A055 100G*

Padana-Grid 10 pc/box 0,12 kg/pc

Angolo/incrocio a 3 o 4 vie in PVC con scarico verticale Ø 40 mm o Ø 80 mm **
 PVC corner/ T or X junction with vertical outlet Ø 40 mm o Ø 80 mm
 Angle/jonction en T ou en X en PVC avec évacuation verticale Ø 40 mm o Ø 80 mm
 PVC Ecke T oder X förmige Kreuzung Ø 40 mm o Ø 80 mm



T055 100G*

Padana-Grid 25 pc/box 0,05 kg/pc

Testata in PVC con scarico orizzontale Ø 50 mm **
 PVC stop-end with horizontal outlet Ø 50 mm
 About en PVC avec évacuation horizontale Ø 50 mm
 Endstück aus PVC mit horizontalem Wasserablauf Ø 50 mm

* Conservare al riparo dalla luce solare ed a temperature < 40°C
 Keep away from sunlight and store at temperatures <40°C
 Conserver à l'abri du rayonnement solaire et à des températures <40 °C
 Vor Sonnenlicht geschützt und bei Temperaturen <40°C lagern

** Scarico da forare in cantiere (solo se necessario)
 outlet to be drilled on the job site (only when necessary)
 Évacuation à percer en chantier (uniquement si nécessaire)
 Wasserablauf auf der Baustelle zu schneiden (erforderlichenfalls)

Mod.CP003-PVC

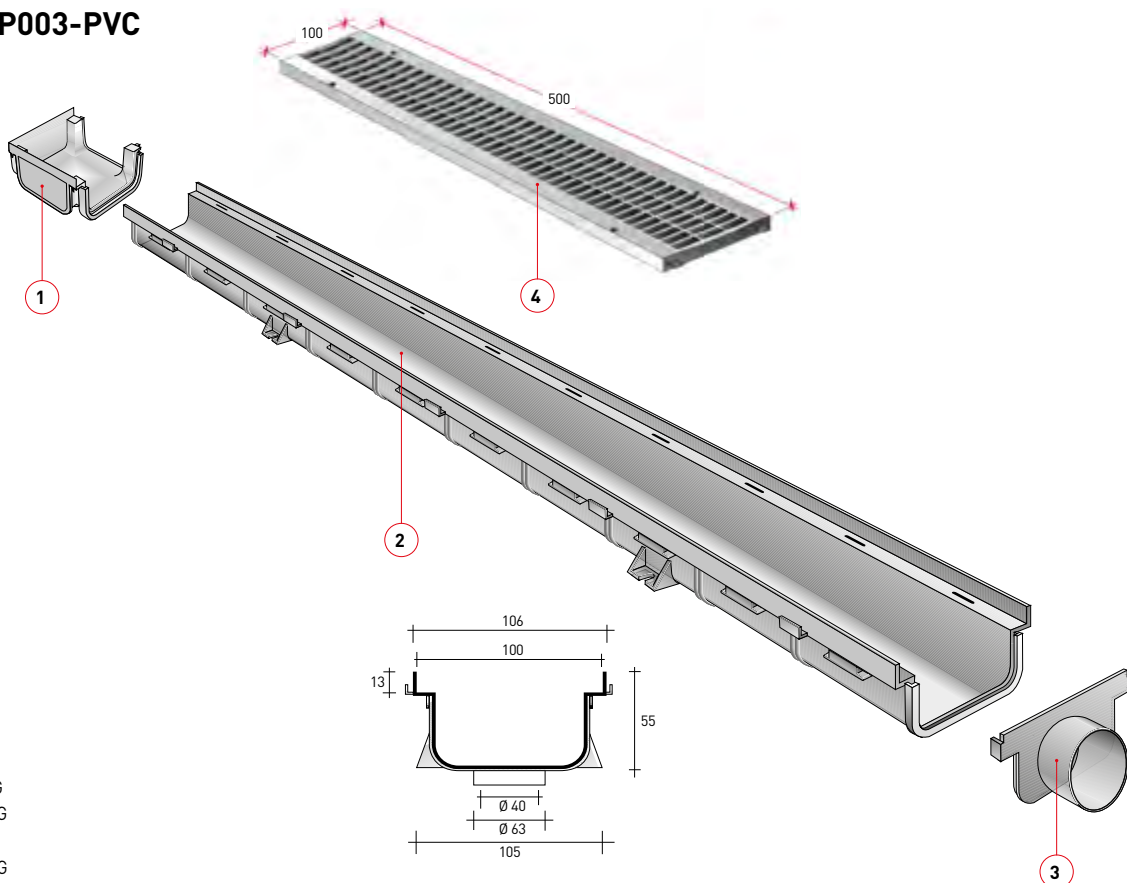

- 1 A055 100G
- 2 C055 100G
- 3 T055 00G
- 4 GPVC 100G

**BOCCHETTE DI SCARICO IMPERMEABILIZZATE PER CANALLETTE DI ESTERNO VASCA WATERPROOFING WATER OUTLETS FOR DECK CHANNELS
EVACUATIONS ETANCHES POUR CANIVEAUX DE PLAGE ABGEDICHTETE WASSERABLÄUFE FÜR BECKENUMGANGSRINNEN**

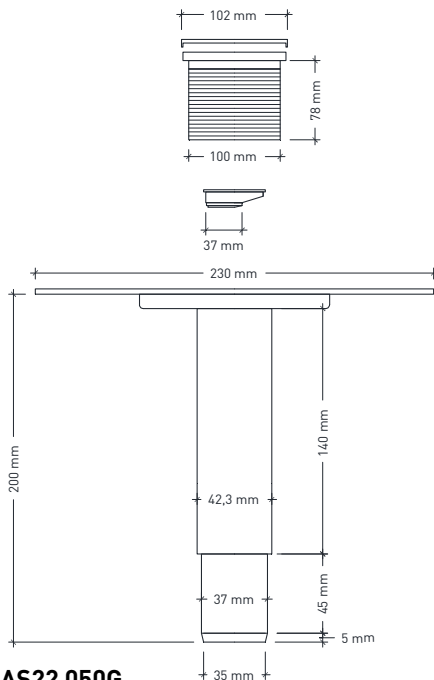
**AS22 050G**

Padana-Deck

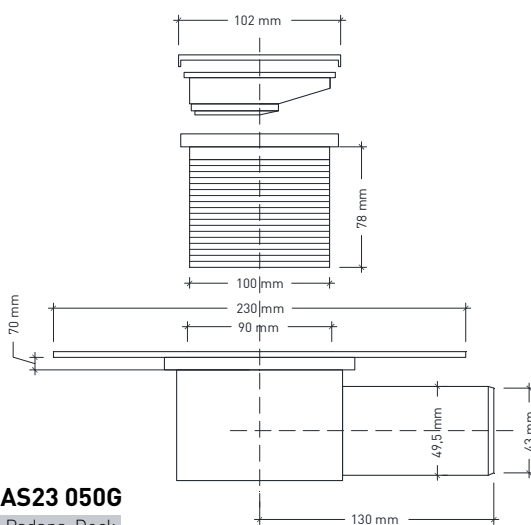
**AS23 050G**

Padana-Deck



Le bocchette di scarico AS22 050G (scarico verticale) e AS23 050G (scarico orizzontale) sono capaci di assicurare la continuità con l'impermeabilizzazione del pavimento circostante grazie al processo di termo fusione che unisce il telo impermeabile con la flangia della bocchetta. Entrambi i modelli sono dotati di scarico con diametro di 35 mm, della prolunga intagliabile per la gestione degli spessori, del tappo antiodore e della elegante griglia in acciaio inox AISI 304 100x100 mm.

The water outlets AS22 050G (vertical) and AS23 050G (horizontal) are able to ensure continuity of waterproofing on pool decks thanks to the waterproofing membrane duly connected with lower part of the outlets. Both models have are equipped with 35 mm drain pipe, with an adjustable extension to manage different thicknesses of concrete, with anti-odour -cap and with an elegant stainless steel grid AISI 304 100x100 mm.

Les siphons AS22 050G (vertical) et AS23 050G (horizontal), garantissent la continuité de l'étanchéité de la plage grâce à la membrane soudé à la partie inférieure des siphons. Les deux modèles sont équipés d'une sortie de 35 mm, d'un rallonge à couper par rapport à l'épaisseur de la chape, d'un coupe-odeurs et d'une élégante grille en acier inox AISI 304 100x100 mm.

Die Wasserabläufe AS22 050G (vertikal) und AS23 050G (horizontal) gewährleisten die Kontinuität mit der Abdichtung des umliegenden Bodens und dies der wasserdichten Membran dankend. Beide Typen sind ausgestattet mit Düse zu 35 mm Durchmesser, einstellbarer Verlängerung um unterschiedlichen Höhen zu regeln, Geruchskappe und eleganter Gitter aus Edelstahl AISI 304 100x100 mm.

Bordi vasca

POOL BORDERS
TETES DE BASSIN
BECKENKÖPFE

La piscina è una costruzione ad elevato contenuto tecnico prestazionale che richiede un approccio progettuale ed una esecuzione cantieristica estremamente accurata: dai sistemi per il recupero acqua al rivestimento in sicurezza degli elementi architettonici.

Quelle che seguono sono alcune proposte dei principali sistemi di bordo vasca completi di pezzi speciali ed accessori ma l'ufficio tecnico della divisione Swimming Pool di Casalgrande Padana è disponibile a sviluppare soluzioni diverse e personalizzate.

Pools are highly technical and performance structures that require extremely accurate design planning and site execution to achieve a perfect final result.

Following is a summary range of different types of pool borders equipped with fittings and accessories, although Casalgrande Padana's Swimming Pool division is available to develop alternative and customized solutions.

La piscine est avant tout une construction très technique qui exige une programmation et une prescription précises afin de pouvoir réaliser un ouvrage parfait : des systèmes de récupération de l'eau aux revêtements sécurisés des éléments architecturaux.

Les suivants ne sont que des exemples des divers types de têtes de bassin équipées de pièces spéciales et accessoires, bien que la division technique Swimming Pool de Casalgrande Padana soit disponible à développer des solutions alternatives et personnalisées.

Ein Schwimmbad ist eine Konstruktion mit einem hohen technischen Gehalt, die einen planerischen Ansatz und eine extrem akkurate Baustellenausführung erforderlich macht: von den Wasseraufbereitungsanlagen bis hin zur sicheren Verkleidung der architektonischen Elemente.

Infolge einige Vorschläge zu den wesentlichen Beckenrandsystemen mit Formteilen und Zubehör. Das Ingenieurbüro der Abteilung Swimming Pool von Casalgrande Padana steht jedoch zur Entwicklung unterschiedlicher und individueller Lösungen zur Verfügung.



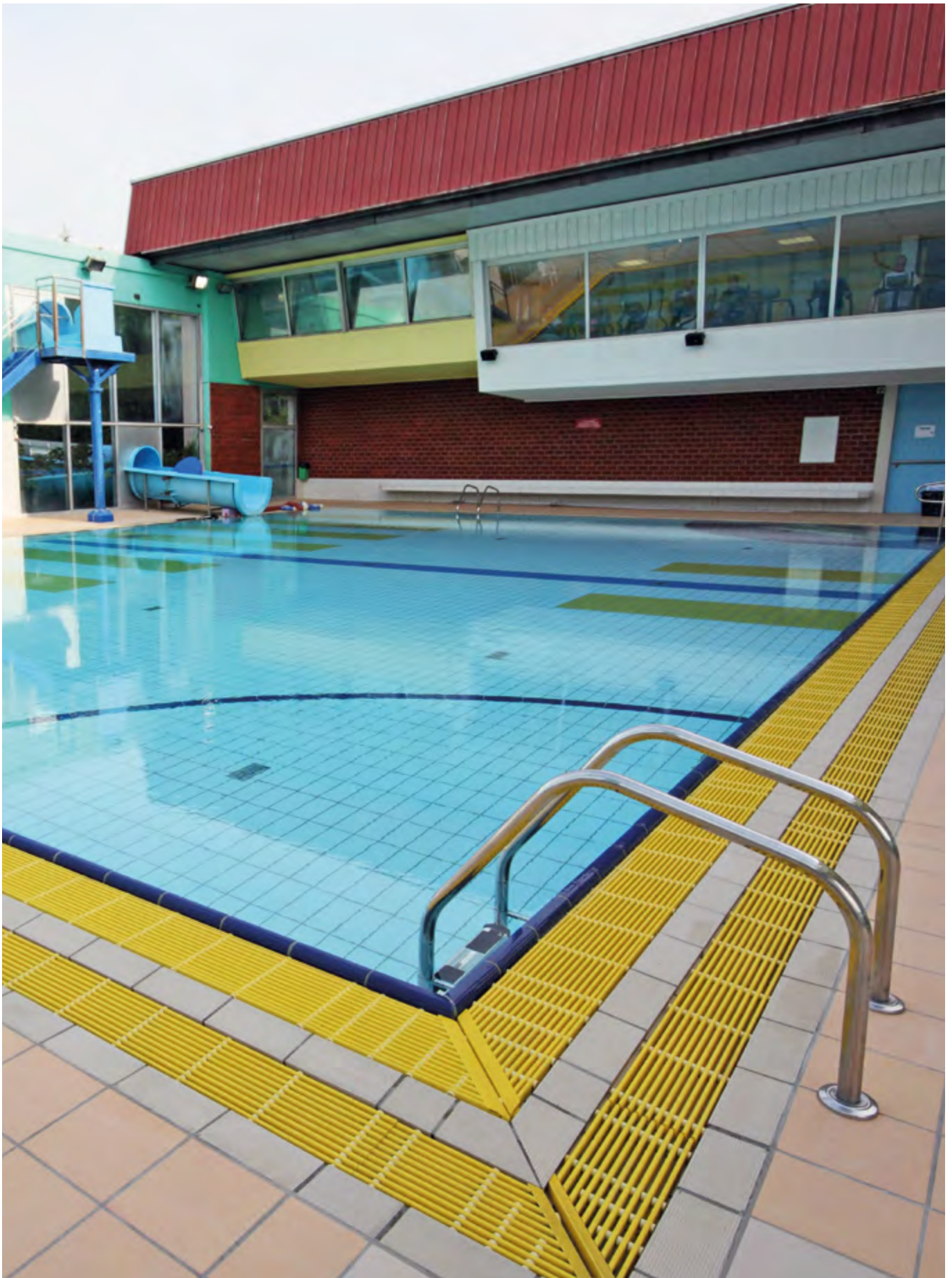

Sistema finlandese

FINNISH SYSTEM
SYSTEME FINLANDAIS
SYSTEM FINNLAND

Il bordo vasca Finlandese è un sistema a sfioro superficiale con prelievo continuo e canaletta di recupero dell'acqua per il ricircolo.

Questo bordo vasca può essere realizzato con pezzi speciali "tradizionali" che comportano una preparazione del sottofondo cementizio adeguatamente sagomato. In questo caso il minor costo dei pezzi utilizzati deve però tener conto di maggiori oneri per la preparazione del supporto in cemento, della impermeabilizzazione e della posa.

Più semplice e rapida è invece la soluzione con gli esclusivi pezzi speciali Trim-Box dove tutti i pezzi del sistema hanno lo stesso spessore e una perfetta modularità. Questo permette di realizzare sagome in c.a. più semplici e facilita la posa dei pezzi speciali.

The Finnish pool border is an overflow system with continuous water collection and a channel to bring water to the re-circulation system.

This type of pool border may be designed with traditional fittings that imply a suitably shaped concrete screed to be installed. The lower cost of the fittings is however, generally offset by additional costs for preparing, concrete, waterproofing and for installation of fittings.

Conversely, the exclusive Trim-Box fittings account for a much easier and quick solution, as they all feature the same thickness and are perfectly modular. As such they allow simpler concrete structures and make easier the installation of fittings.

La tête de bassin finlandaise est un système à débordement par surverse et goulotte de récupération de l'eau pour son recyclage.

Ce type de tête de bassin est réalisé par des pièces spéciales « traditionnelles » qui entraînent la préparation du béton correctement modelé.

Le cout inférieur des pièces utilisées est toutefois compensé par des frais supplémentaires de préparation du béton, d'exécution de l'étanchéité et de la pose.

D'ailleurs, les pièces spéciales Trim-Box à épaisseur égale offrent une solution plus simple et rapide grâce à leur parfaite modularité, ce qui permet de simplifier la réalisation des supports en béton et la pose de ces pièces.

Die Finnische Rinne ist ein Überlaufsystem mit Schwallwasserkanal für die Wasseraufbereitung.

Dieser Beckenrand kann mit "traditionellen" Formteilen verlegt werden, die eine Vorbereitung des Zementuntergrundes mittels angemessener Formung erforderlich machen.

In diesem Fall müssen jedoch obgleich der geringeren Kosten der verwendeten Teile der Mehraufwand bei der Vorbereitung des Zementträgers, bei der Abdichtung sowie beim Verlegen berücksichtigt werden.

Einfacher und schneller ist hingegen eine Verwendung der exklusiven Formteile Trim-Box. Alle Teile dieses Systems haben die gleiche Stärke sowie eine perfekte Modularbauweise. Das gestattet die Konstruktion von einfacheren Profilen aus Stahlbeton und vereinfacht das Verlegen der Formteile.

sistema finlandese / finnish system / système finlandais / system finland



BORDO FINLANDESE TRADIZIONALE SENZA AGGRAPPO – SUPERFICIE PINHEAD FINNISH POOL BORDER WITHOUT FINGER GRIP – SURFACE PINHEAD
TÊTE FINLANDAISE TRADITIONNELLE SANS ACCROCHE DOIGTS – FINITION PINHEAD BECKENKOPFEN FINNLAND OHNE HANDFASS – OBERFLÄCHE PINHEAD

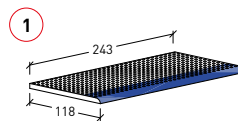
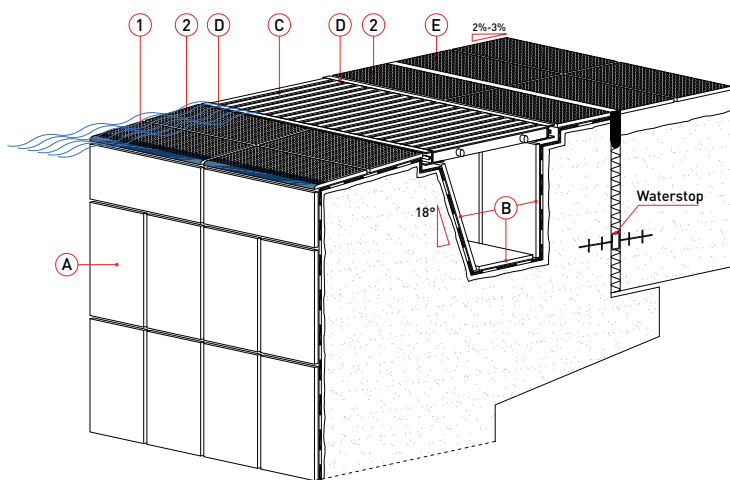

3356 Banda blu

ELEMENTI - Pinhead

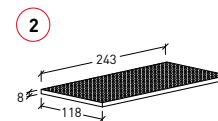

1100

ELEMENTI - Pinhead

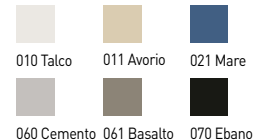

mod. FEP 1100.0

- A** LANDSCAPE - Satin_interno vasca / pool tank / interieur bassin / becken
- B** LANDSCAPE - Satin_canaletta di ricircolo / overflow channel / caniveau eau bassin / rinne
- C** PADANA GRID_griglia in pvc / grating in pvc / grille en pvc / pvc rost
- D** PADANA GRID_angolare in pvc / pvc grating support / corniere en pvc / pvc rost traeger
- E** ELEMENTI - Pinhead_esterno vasca / pool surround / plage / beckenumgang

BORDO FINLANDESE TRADIZIONALE CON AGGRAPPO – SUPERFICIE PINHEAD FINNISH POOL BORDER WITH FINGER GRIP – SURFACE PINHEAD
TÊTE FINLANDAISE TRADITIONNELLE AVEC ACCROCHE DOIGTS – FINITION PINHEAD BECKENKOPF FINNLAND MIT HANDFASS – OBERFLÄCHE PINHEAD

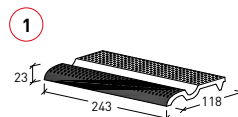
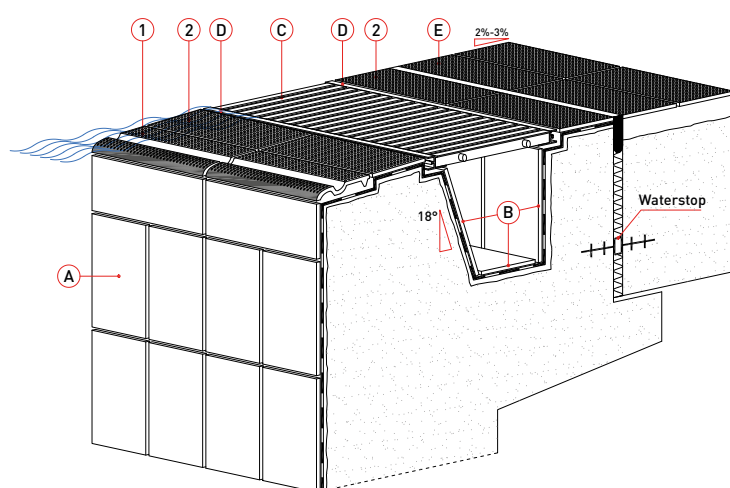

7300 Banda Nera

ELEMENTI - Pinhead

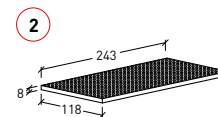

1100

ELEMENTI - Pinhead

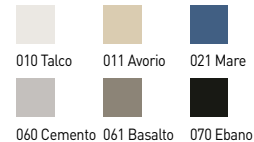

mod. FCP 1101.0

- A** LANDSCAPE - Satin_interno vasca / pool tank / interieur bassin / becken
- B** LANDSCAPE - Satin_canaletta di ricircolo / overflow channel / caniveau eau bassin / rinne
- C** PADANA GRID_griglia in pvc / grating in pvc / grille en pvc / pvc rost
- D** PADANA GRID_angolare in pvc / pvc grating support / corniere en pvc / pvc rost traeger
- E** ELEMENTI - Pinhead_esterno vasca / pool surround / plage / beckenumgang

BORDO FINLANDESE TRADIZIONALE CON AGGRAPPO – SUPERFICIE RIGATA FINNISH POOL BORDER WITH FINGER GRIP – SURFACE RIGATA / TÊTE FINLANDEISE TRADITIONNELLE AVEC ACCROCHE DOIGTS – FINITION RIGATA BECKENKOPF FINNLAND MIT HANDFASS – OBERFLÄCHE RIGATA

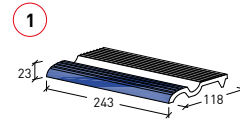
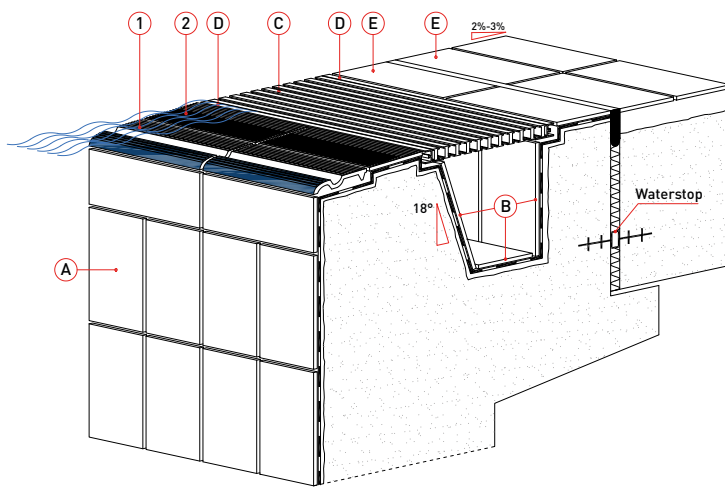
**7200 Banda Blu**

LANDSCAPE - Rigata



100 Tundra

ELEMENTI - Rigata

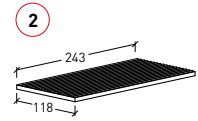

010 Talco

**3200**

LANDSCAPE - Rigata



100 Tundra

ELEMENTI - Rigata



010 Talco

011 Avorio

mod. FCC 1101.0

- A** LANDSCAPE - Satin_interno vasca / pool tank / interieur bassin / becken
- B** LANDSCAPE - Satin_canaletta di ricircolo / overflow channel / caniveau eau bassin / rinne
- C** PADANA GRID_griglia in pvc / grating in pvc / grille en pvc / pvc rost
- D** PADANA GRID_angolare in pvc / pvc grating support / corniere en pvc / pvc rost traeger
- E** ELEMENTI - Matt_esterno vasca / pool surround / plage / beckenumgang

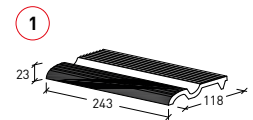
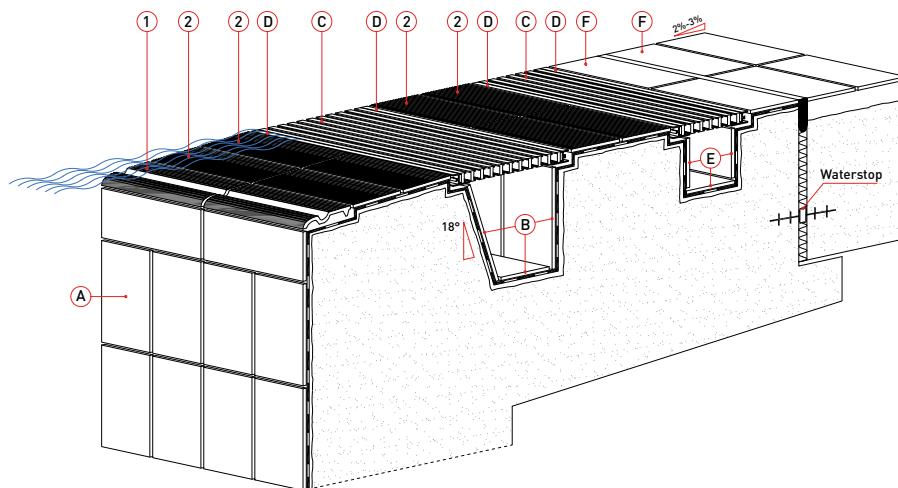
**7200 Banda Nera**

LANDSCAPE - Rigata

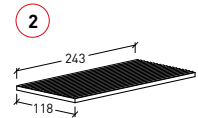

100 Tundra

**3200**

LANDSCAPE - Rigata



100 Tundra

mod. FCC 2200.0

- A** LANDSCAPE - Satin_interno vasca / pool tank / interieur bassin / becken
- B** LANDSCAPE - Satin_canaletta di ricircolo / overflow channel / caniveau eau bassin / rinne
- C** PADANA GRID_griglia in pvc / grating in pvc / grille en pvc / pvc rost
- D** PADANA GRID_angolare in pvc / pvc grating support / corniere en pvc / pvc rost traeger
- E** LANDSCAPE - Satin_canaletta esterna / external channel / caniveau extérieur / aussenrinne
- F** ELEMENTI - Matt_esterno vasca / pool surround / plage / beckenumgang

BORDO FINLANDESE TRIM-BOX – SUPERFICIE RIGATA FINNISH POOL BORDER WITH FINGER GRIP – SURFACE RIGATA
TÊTE FINLANDAISE TRADITIONNELLE AVEC ACCROCHE DOIGTS – FINITION RIGATA BECKENKOPF FINNLAND MIT HANDFASS – OBERFLÄCHE RIGATA

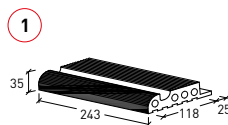
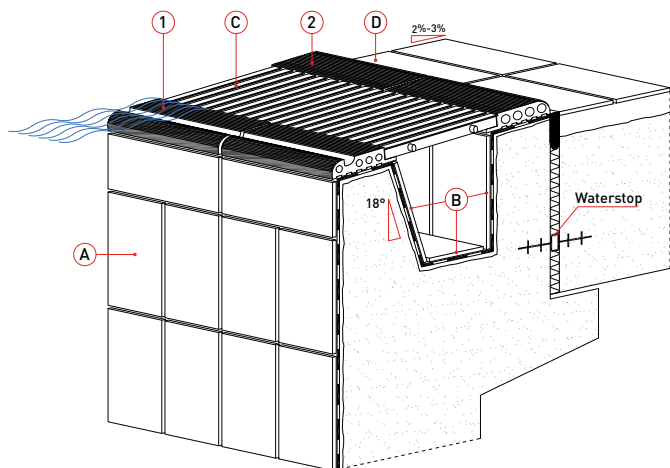

7800 Banda Nera

Trim-Box

LANDSCAPE - Rigata

100 Tundra

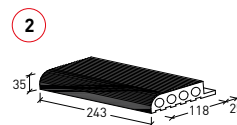

9546 Banda Nera

Trim-Box

LANDSCAPE - Rigata

100 Tundra

P106-0242

Polyfill cilindro / cylinder / cilindre / Zylinder
 (4 pcs)*

P102-0242

Polyfill cilindro / cylinder / cilindre / Zylinder
 (4 pcs)*

* Vedi pagina: See page: Voir page: Siehe Seite: 36

mod. FTR 0121.2

TRIM BOX

- A** LANDSCAPE - Satin_interno vasca / pool tank / interieur bassin / becken
- B** LANDSCAPE - Satin_canaletta di ricircolo / overflow channel / caniveau eau bassin / rinne
- C** PADANA GRID_griglia in pvc / grating in pvc / grille en pvc / pvc rost
- D** ELEMENTI - Matt_esterno vasca / pool surround / plage / beckenumgang

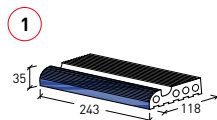
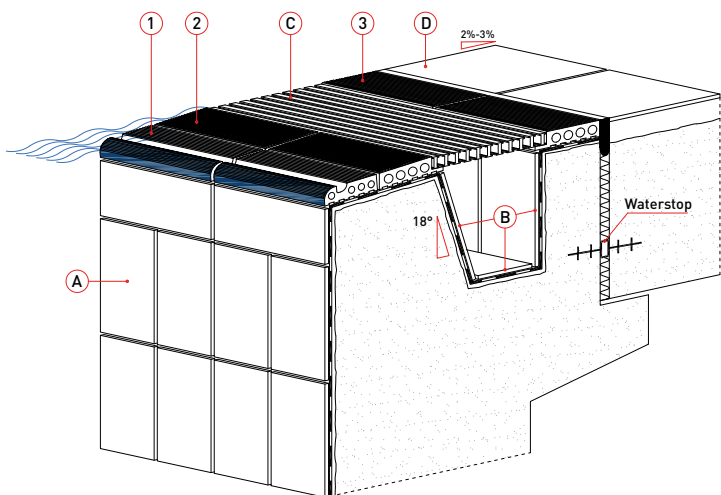

7500 Banda Blu

Trim-Box

LANDSCAPE - Rigata

100 Tundra

P106-0242

Polyfill cilindro / cylinder / cilindre / Zylinder
 (4 pcs)*

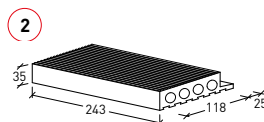

8800

Trim-Box

LANDSCAPE - Rigata

100 Tundra

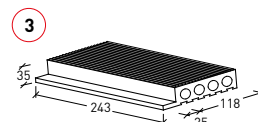

8600

Trim-Box

LANDSCAPE - Rigata

100 Tundra

mod. FTR 1121.0

TRIM BOX

- A** LANDSCAPE - Satin_interno vasca / pool tank / interieur bassin / becken
- B** LANDSCAPE - Satin_canaletta di ricircolo / overflow channel / caniveau eau bassin / rinne
- C** PADANA GRID_griglia in pvc / grating in pvc / grille en pvc / pvc rost
- D** ELEMENTI - Matt_esterno vasca / pool surround / plage / beckenumgang

P102-0242

Polyfill cilindro / cylinder / cilindre / Zylinder
 (4 pcs)*

P102-0242

Polyfill cilindro / cylinder / cilindre / Zylinder
 (4 pcs)*

* Vedi pagina: See page: Voir page: Siehe Seite: 36

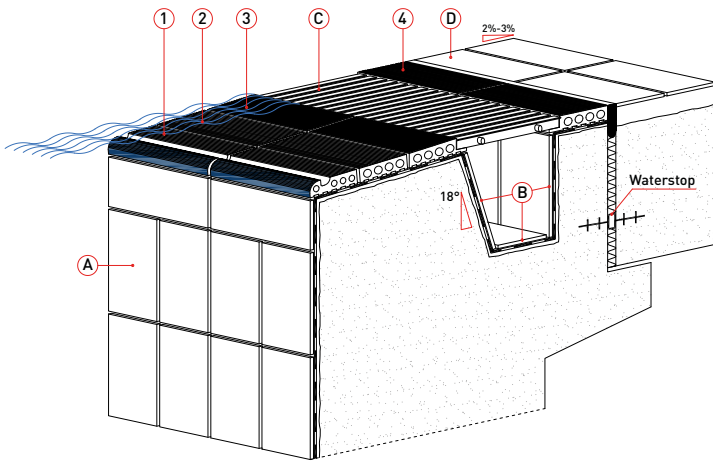

mod. FTR 2121.0
TRIM BOX

- A** LANDSCAPE - Satin_interno vasca / pool tank / interieur bassin / becken
B LANDSCAPE - Satin_canaletta di ricircolo / overflow channel / caniveau eau bassin / rinne
C PADANA GRID_griglia in pvc / grating in pvc / grille en pvc / pvc rost
D ELEMENTI - Matt_esterno vasca / pool surround / plage / beckenumgang

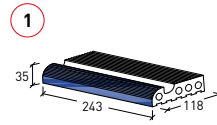

7500 Banda Blu

Trim-Box

LANDSCAPE - Rigata

100 Tundra

P106-0242

Polyfill cilindro / cylinder / cilindre / Zylinder

(4 pcs)*

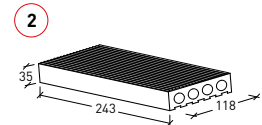

8100

Trim-Box

LANDSCAPE - Rigata

100 Tundra

P102-0242

Polyfill cilindro / cylinder / cilindre / Zylinder

(4 pcs)*

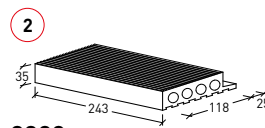

8800

Trim-Box

LANDSCAPE - Rigata

100 Tundra

P102-0242

Polyfill cilindro / cylinder / cilindre / Zylinder

(4 pcs)*

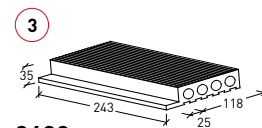

8600

Trim-Box

LANDSCAPE - Rigata

100 Tundra

P102-0242

Polyfill cilindro / cylinder / cilindre / Zylinder

(4 pcs)*

* Vedi pagina: See page: Voir page: Siehe Seite: 36



Sistema Wiesbaden a pavimento e a parete

WIESBADEN SYSTEM - HIGH LEVEL AND LOW LEVEL
SYSTEME WIESBADEN SURFLOT ET SYSTEME WIESBADEN EN PAROI
SYSTEM WIESBADEN HOCHLIEGEND UND SYSTEM WIESBADEN TIEFLIEGEND

Il bordo vasca Wiesbaden a pavimento viene utilizzato in genere per vasche indoor quando, per esigenze di spazio, si ha la necessità di contenere la larghezza complessiva del bordo vasca.

Decisamente interessante e flessibile risulta la soluzione con i pezzi speciali Trim-Box che consentono di dimensionare a piacere la larghezza della canaletta, di creare il lato inclinato per ridurre il rumore dell'acqua e di usare pezzi con colori diversi.

Il sistema Wiesbaden nella versione a parete lascia completamente libero il bordo superiore della vasca che quindi non necessita di particolari pezzi speciali di finitura.

E' un sistema di vecchia concezione che oggigiorno viene installato prevalentemente per vasche particolari come quelle terapeutiche o di arrivo scivoli.

The Wiesbaden high-level system is usually used for indoor pools where, for reasons of space, a reduction of the total width of the pool border is required.

The Trim-Box solution, is very interesting and flexible, since it allows any width of the channel, a sloping side to reduce the noise of water and use pieces of different colours.

The Wiesbaden low-level system, leaves the upper wall of the pool border completely free and do not require any particular fitting.

This is a old-fashioned system almost exclusively used for specific pools such as therapeutic or slide-equipped pools.

En général, le système Wiesbaden surfлот est utilisé pour bassins d'intérieur où une réduction de la largeur totale de la tête est exigée.

La solution avec pièces spéciales Trim-Box est très intéressante et flexible, vu qu'elle permet de créer une goulotte dimensionnée en largeur selon les exigences, en plus d'introduire un pan coupé réduisant le bruit de l'eau et d'habiller avec pièces en couleurs différentes.

Le système Wiesbaden en paroi laisse la partie supérieure du bassin libre, qui n'exige, par conséquent, aucune pièce spéciale de finition particulier.

Il s'agit d'un système aujourd'hui utilisé presque exclusivement pour des bassins particuliers tels que ceux thérapeutiques ou les bassins de réception toboggan.

Die Wiesbadener Rinne mit hochliegendem Wasserspiegel wird normalerweise bei Innenpools verwendet, besteht aus Patzgründen die Notwendigkeit, die Gesamtbreite des Beckenrandes zu beschränken.

Die Lösung mit den speziellen Trim-Box-Teilen ist sehr interessant und flexibel, da sie es ermöglicht, einen Kanal in der Breite entsprechend den Anforderungen zu erstellen, sowie eine abgeschrägte Ecke einzuführen, um das Wasserrauschen zu reduzieren und mit Teilen in verschiedenen Farben zu verschönern.

Die Wiesbadener Rinne mit tiefliegendem Wasserspiegel lässt den oberen Beckenrand vollkommen frei. Dieser benötigt daher keine besonderen Beckenrandteile.

Es handelt sich um ein veraltetes System, das heutzutage vorwiegend in besonderen Becken, wie Therapie- oder Rutschbecken, installiert wird.

sistema wiesbaden a pavimento e a parete / wiesbaden system - high level and low level /
systeme wiesbaden surflot et systeme wiesbaden en paroi /
system wiesbaden hochliegend und system wiesbaden tieflegend



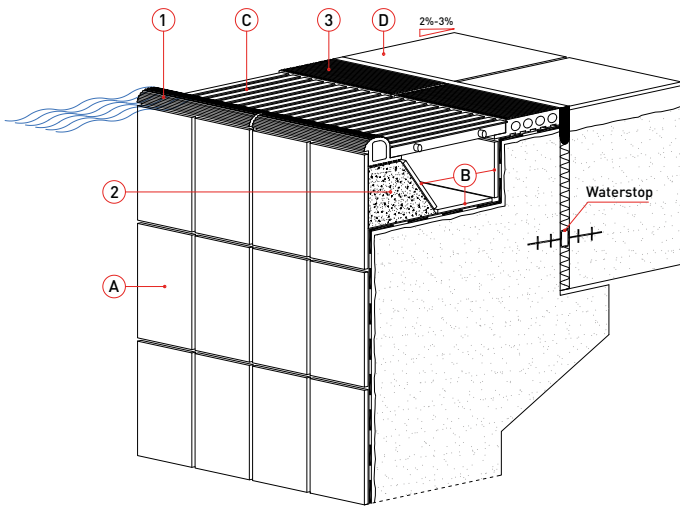

**mod. WSC CLS
TRIM-BOX**

- A** LANDSCAPE - Satin_interno vasca / pool tank / interieur bassin / becken
- B** LANDSCAPE - Satin_canaletta di ricircolo / overflow channel / caniveau eau bassin / rinne
- C** PADANA GRID_griglia in pvc / grating in pvc / grille en pvc / pvc rost
- D** ELEMENTI - Matt_esterno vasca / pool surround / plage / beckenumgang

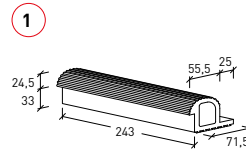

6550
Trim-Box
LANDSCAPE - Rigata
202 Ocean

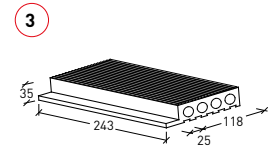

8600
Trim-Box
LANDSCAPE - Rigata
100 Tundra

P104-0242
Polyfill profilo / profile / profil / Profil
(1 pc)*

P102-0242
Polyfill cilindro / cylinder / cilindre / Zylinder
(4 pcs)*

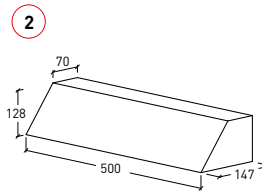

6415
Betonbuild

* Vedi pagina: See page: Voir page: Siehe Seite: 36

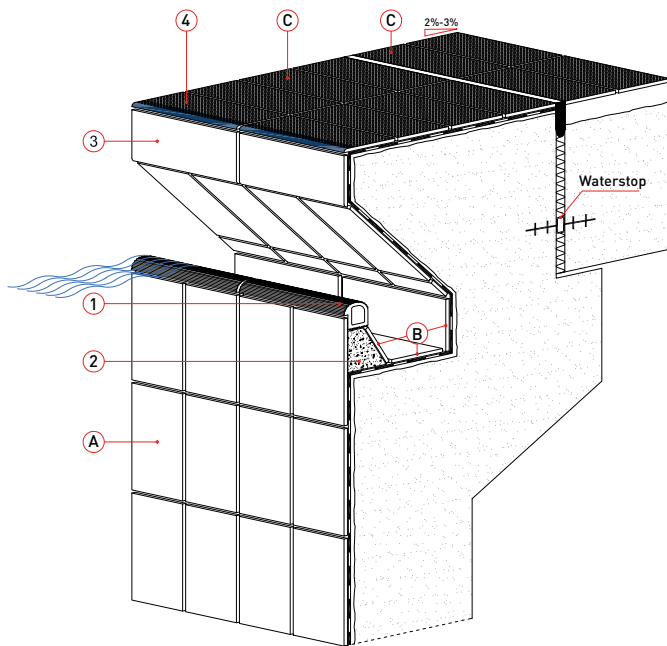

**mod. WSP 0131.17
TRIM-BOX**

- A** LANDSCAPE - Satin_interno vasca / pool tank / interieur bassin / becken
- B** LANDSCAPE - Satin_canaletta di ricircolo / overflow channel / caniveau eau bassin / rinne
- C** ELEMENTI - Pinhead_esterno vasca / pool surround / plage / beckenumgang

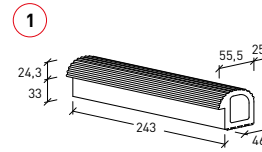

6050
Trim-Box
LANDSCAPE - Rigata
202 Ocean

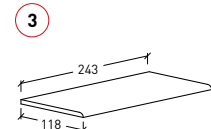

1106
LANDSCAPE - Satin
100 Tundra 200 Bay 202 Ocean

P104-0242
Polyfill profilo / profile / profil / Profil
(1 pc)*

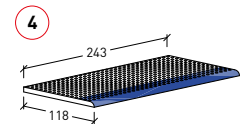

3356 Banda Blu
ELEMENTI - Pinhead
010 Talco 011 Avorio

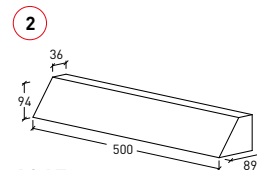

6315
Betonbuild

* Vedi pagina: See page: Voir page: Siehe Seite: 36

sistema wiesbaden a pavimento e a parete / wiesbaden system - high level and low level /
systeme wiesbaden surflot et systeme wiesbaden en paroi /
system wiesbaden hochliegend und system wiesbaden tieflegend

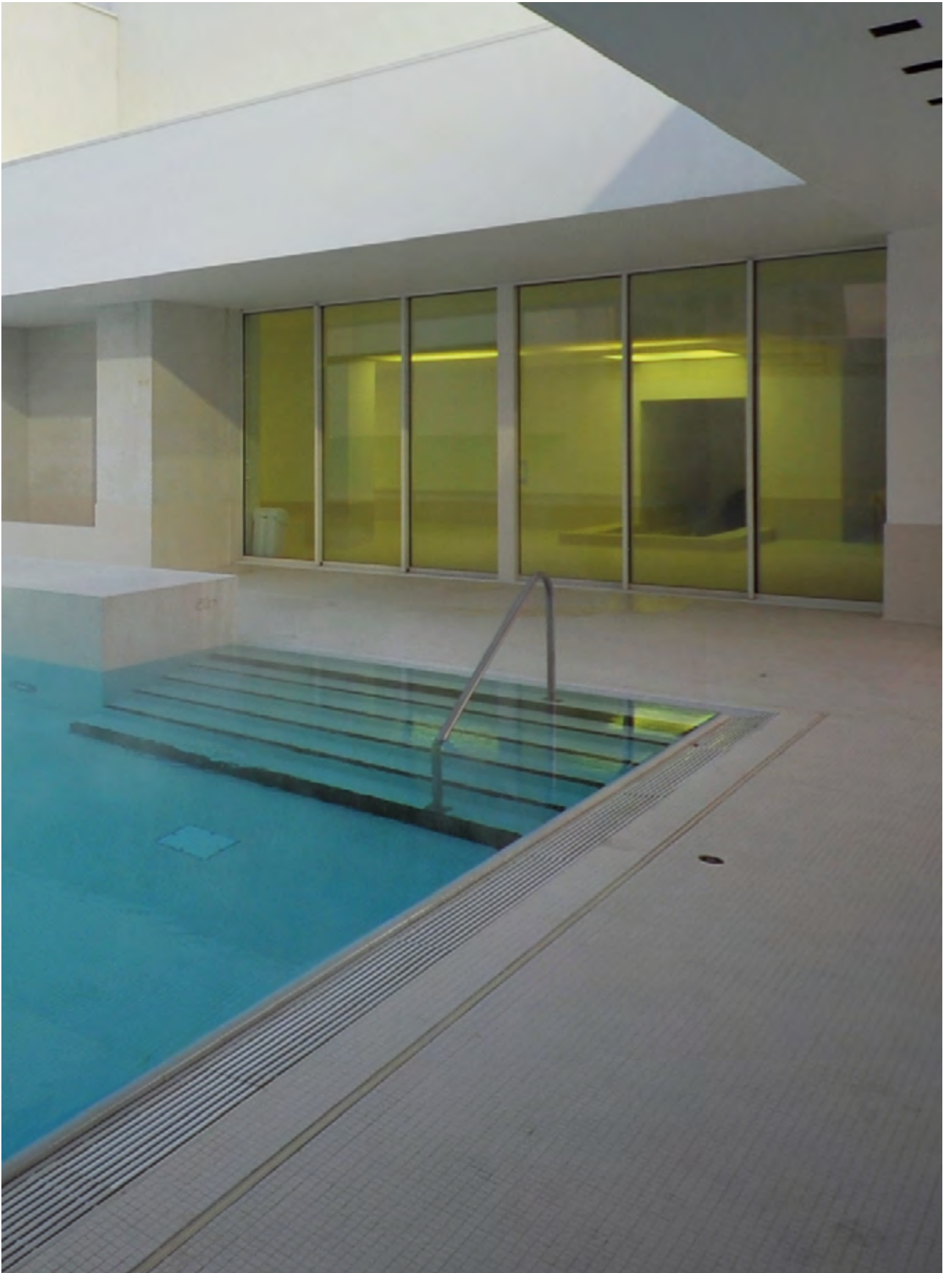

Sistema St. Moritz

ST. MORITZ SYSTEM
SYSTEME ST. MORITZ
SYSTEM ST. MORITZ

Il bordo vasca St. Moritz è in genere utilizzato per vasche terapeutiche oppure quando, per ragioni tecniche, è necessario avere una parte della vasca fuori terra.

Le sua funzionalità si presta inoltre a creare suggestivi effetti cascata anche in vasche ludiche e ricreative.

La canaletta di recupero dell'acqua sottostante allo sfioro può essere poi realizzata sia con pezzi tradizionali che con pezzi speciali del sistema Trim-Box.

The St. Moritz system is mainly used for therapeutic pools or when, due to technical requirements, a part of the pool must remain above ground level.

Its functionality is also perfect to fashion suggestive effects in leisure and recreational pools.

The channel underneath the overflow can be made both with traditional fittings or Trim-Box system pieces.

La tête de bassin St. Moritz est surtout utilisée pour les bassins thérapeutiques ou lors des exigences techniques imposent des piscines hors sol.

Sa fonctionnalité permet aussi de créer de suggestifs effets cascade pour les bassins ludiques.

La goulotte de récupération de l'eau au-dessous du débordement peut être réalisée avec des pièces traditionnelles ou des pièces spéciales du système Trim-Box.

Die St. Moritz-Rinne wird im Allgemeinen für Therapiebecken verwendet oder wenn es aus technischen Gründen erforderlich ist, dass ein Teil des Beckens aus dem Boden herausragt.

Dank ihrer Funktionsweise eignet sie sich außerdem in Spiel- und Freizeitbecken zur Erzeugung faszinierender Wasserfalleffekte.

Die unter dem Überlauftrand liegende Schwallwasserrinne kann sowohl mit traditionellen Teilen als auch mit Formteilen des Trim-Box-Systems verwirklicht werden.

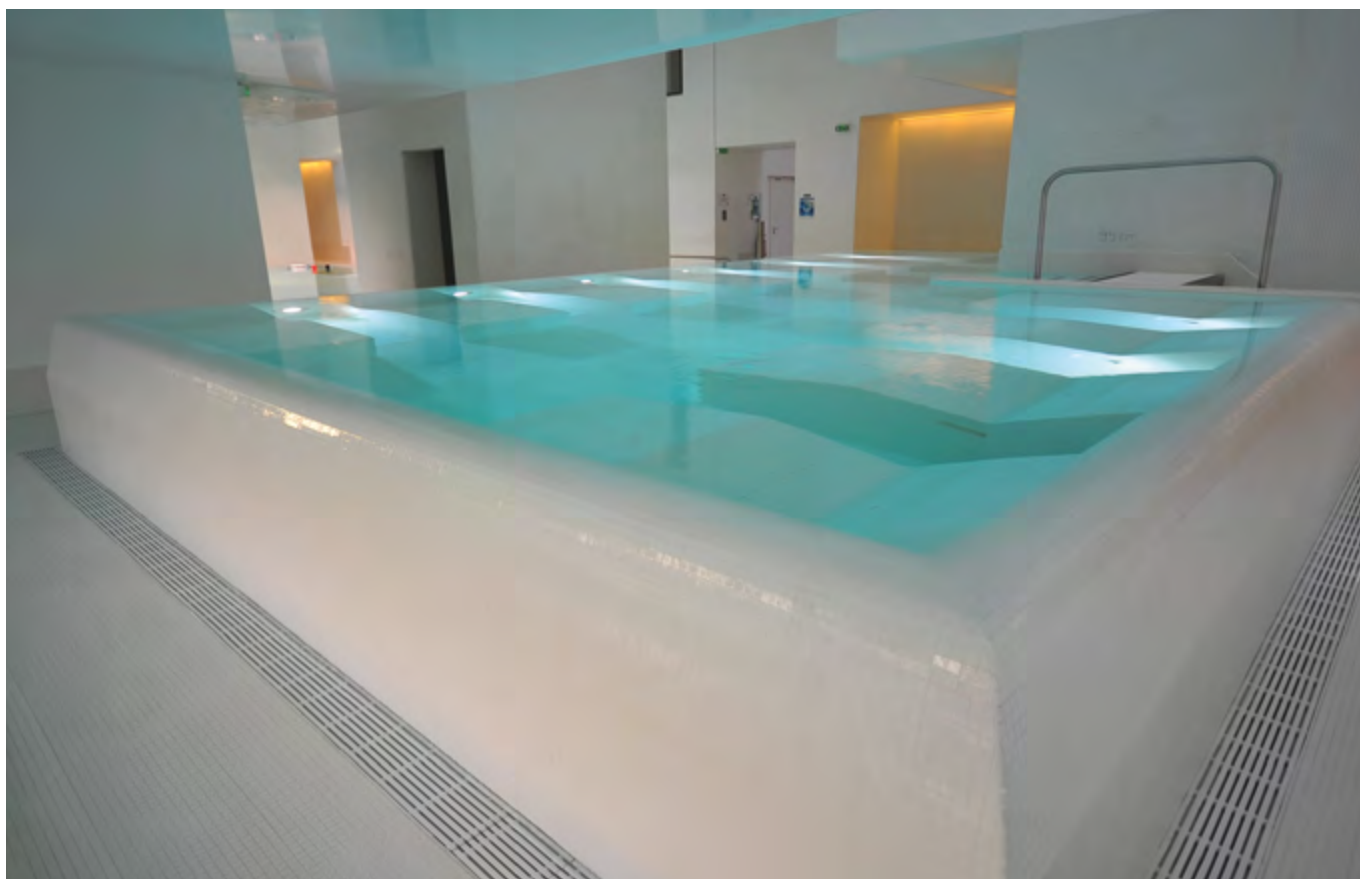

sistema St. Moritz / St. Moritz system /
système St. Moritz / system St. Moritz

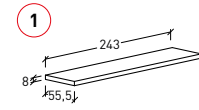
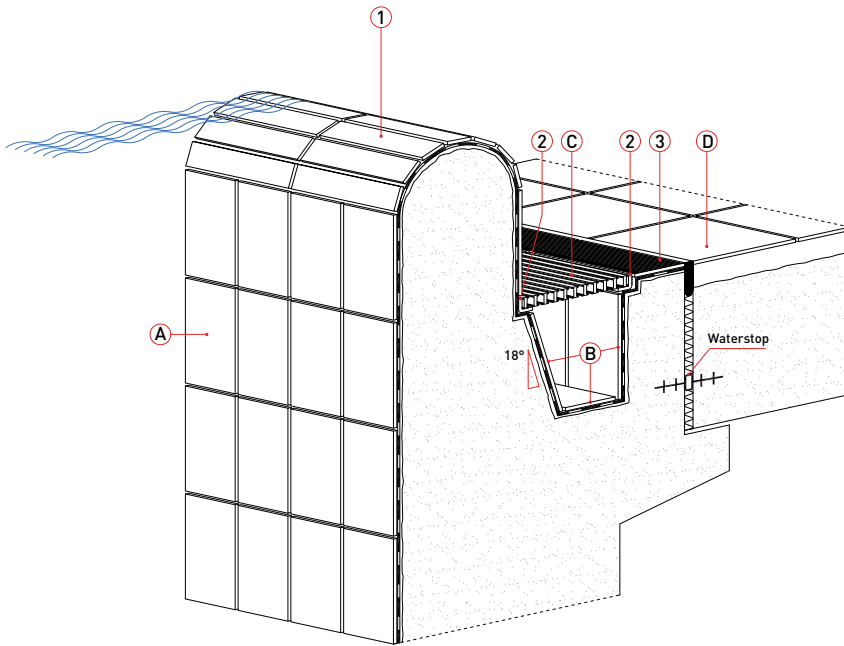

LANDSCAPE - Satin
 100 Tundra 200 Bay 202 Ocean

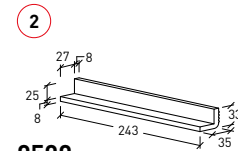

0500
 Padana-Grid

LANDSCAPE - Satin
 100 Tundra

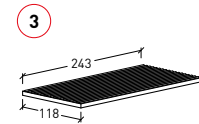

3200
LANDSCAPE - Rigata
 100 Tundra 202 Ocean

ELEMENTI - Rigata
 010 Talco 011 Avorio

mod. SM 0101.1

- A** LANDSCAPE - Satin_interno vasca / pool tank / interieur bassin / becken
- B** LANDSCAPE - Satin_canaletta di ricircolo / overflow channel / caniveau eau bassin / rinne
- C** PADANA GRID_griglia in pvc / grating in pvc / grille en pvc / pvc rost
- D** LANDSCAPE - Satin_esterno vasca / pool surround / plage / beckenumgang

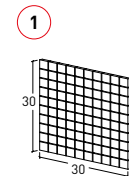
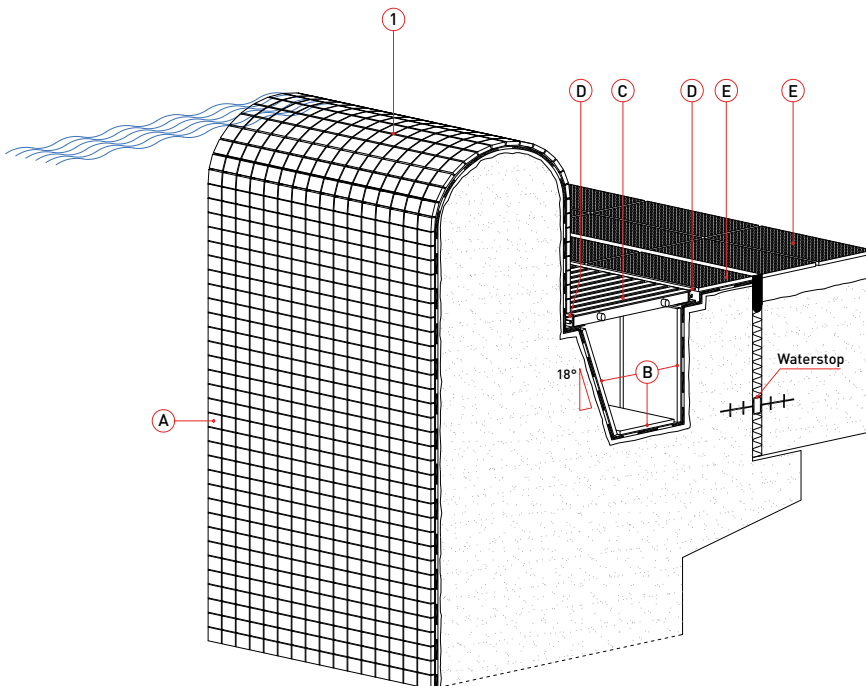

2700 - MOSAICI LS Uni

LANDSCAPE - Satin
 100 Tundra 200 Bay 202 Ocean

Vedi pagina: See page: Voir page: Siehe Seite: 26

mod. SM 0101.2

- A** LANDSCAPE - Satin_interno vasca / pool tank / interieur bassin / becken
- B** LANDSCAPE - Satin_canaletta di ricircolo / overflow channel / caniveau eau bassin / rinne
- C** PADANA GRID_griglia in pvc / grating in pvc / grille en pvc / pvc rost
- D** PADANA GRID_angolare in pvc / pvc grating support / corniere en pvc / pvc rost traeger
- E** ELEMENTI - Pinhead_esterno vasca / pool surround / plage / beckenumgang

Sistema Skimmer

SKIMMER SYSTEM
SYSTEME SKIMMERS
SYSTEM SKIMMER

Il sistema a Skimmer ha una funzionalità diversa da quella delle piscine con sfioro superficiale e viene in genere utilizzato per piscine private o comunque di piccole dimensioni.

Le funzioni del pezzo di bordo vasca sono essenzialmente quelle di evitare che l'acqua presente sul piano vasca entri nella piscina e di fornire un aggrappo agli utilizzatori.

The skimmer system has a different function from overflow systems and is normally used for private or reduced-size pools.

The edging pieces serve essentially as finger grip and to prevent water from the pool deck entering into the pool.

Le système à skimmer a une fonction différente par rapport à celle des piscines à débordement de surface et il est normalement utilisé pour les piscines privées ou, en tout cas, aux dimensions réduites.

La pièce de bordure sert essentiellement d'accroche-doigts et à empêcher à l'eau de plage de pénétrer dans la piscine.

Das Skimmer-System hat eine Funktionsweise, die sich von der Funktion der Schwimmbecken mit ständiger Abnahme des Oberflächenwassers unterscheidet, und wird im Allgemeinen in privaten oder kleinen Schwimmbecken verwendet.

Der Beckenkopf hat hauptsächlich die Funktion zu verhindern, dass das auf der Beckenplatte vorhandene Wasser in den Pool zurück läuft, sowie dem Badegast als Handfasse zu dienen.

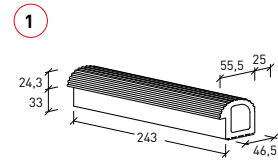
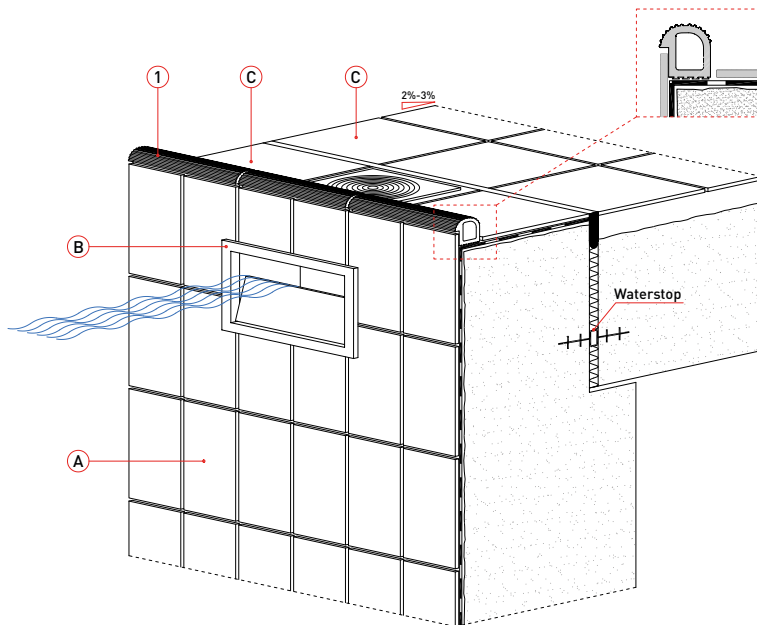

sistema skimmer / skimmer system /
système skimmers / system skimmer

**6050**

Trim-Box

LANDSCAPE - Rigata



202 Ocean

P104-0242

Polyfill profilo / profile / profil / Profil

(1 pc)*

* Vedi pagina: See page: Voir page: Siehe Seite: 36

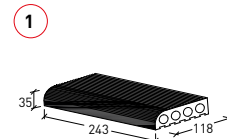
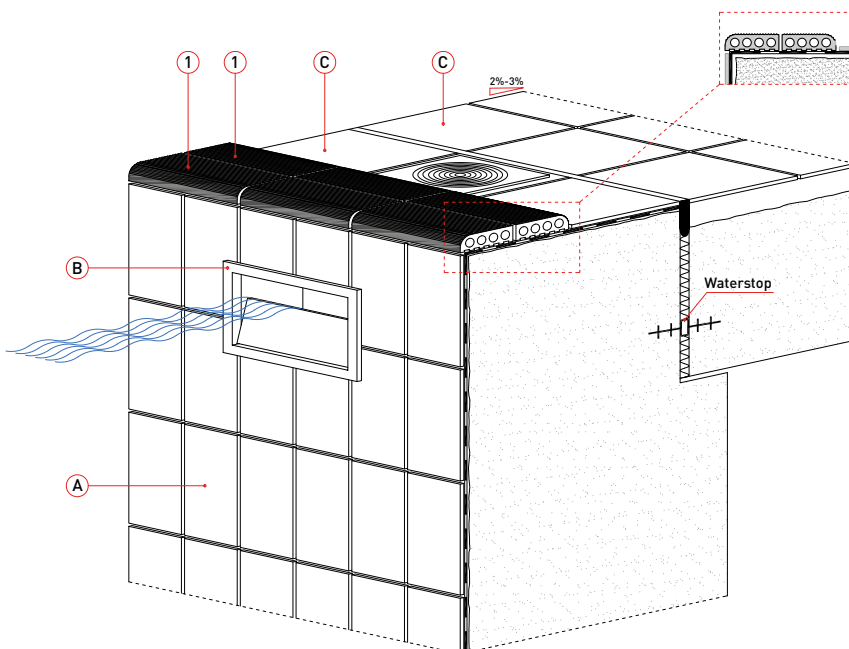
mod. SK 6050**TRIM-BOX****A** LANDSCAPE - Satin_interno vasca / pool tank / interieur bassin / becken**B** Skimmer**C** ELEMENTI - Matt_esterno vasca / pool surround / plage / beckenumgang**9046 Banda Nera**

Trim-Box 6 pc/box 1,8 kg/pc 4 pc/ml

LANDSCAPE - Rigata



100 Tundra

P102-0242

Polyfill cilindro / cylinder / cilindre / Zylinder

(4 pcs)*

* Vedi pagina: See page: Voir page: Siehe Seite: 36

mod. SK 9046**TRIM-BOX****A** LANDSCAPE - Satin_interno vasca / pool tank / interieur bassin / becken**B** Skimmer**C** ELEMENTI - Matt_esterno vasca / pool surround / plage / beckenumgang

Muretti di testata

STARTING HEADWALLS
QUAIS DE DEPART
STIRNWÄNDE

I muretti di testata, generalmente disposti sui lati corti delle vasche sportive, sono una modalità costruttiva spesso preferita in quanto più economici rispetto ai bordi a sfioro.

I muretti di testata hanno generalmente una larghezza di 50 cm, un'altezza dal livello dell'acqua di 30 cm ed una superficie con grado di antiscivolo a piedi nudi di gruppo C.

È consigliabile realizzare muretti di larghezza non inferiore a 35/40 cm per consentire la collocazione dei blocchi di partenza prefabbricati.

Per avere un miglior risultato estetico e per ottimizzare i tempi e i costi si suggerisce che larghezza e lunghezza dei muretti siano modulari a piastrelle e a pezzi speciali interi.

Starting headwalls arranged on the short sides of sports pools are generally used because they are cheaper compared to overflow.

Starting headwalls usually are 50-cm wide, with a height of about 30 cm on water level and a group C non-slip barefoot surface coefficient.

It is recommended to make sure the headwalls are no less than 35/40 cm wide in order to have the necessary space to install the prefabricated starting blocks.

To have a better aesthetic result and optimise times and costs, it is suggested that headwall width and length be modular to full tiles and fittings.

Les quais de départ, d'habitude disposés sur les cotés courts des bassins sportifs sont assez utilisés car ils sont normalement plus économiques par rapport à la majorité des têtes de bassin à débordement.

Les quais de départ ont d'habitude une largeur de 50 cm, une hauteur minimale de 30 cm sur le niveau d'eau et une surface horizontale avec un coefficient antidérapant pieds nus de group C.

On peut prévoir des largeurs inférieures mais on recommande au moins une largeur de 35/40 cm pour disposer de la place nécessaire à poser les plots de départ préfabriqués.

Pour les réaliser, il est préférable que largeur et longueur soient modulaires, à carreaux et/ou pièces spéciales entières, dans le but d'optimiser temps et couts de construction et d'obtenir un résultat esthétique supérieur.

Die Stirnwände, die sich normalerweise an den kurzen Seiten der Sportschwimmbecken befinden, stellen eine aufgrund der geringeren Kosten im Vergleich zu den Überlaufändern häufig bevorzugte Bauweise dar.

Die Stirnwände haben im Allgemeinen eine Breite von 50 cm, eine Höhe über dem Wasserspiegel von 30 cm und eine Oberfläche mit einem Rutschfestigkeitskoeffizienten der Gruppe C bei barfußigem Betreten.

Die Konstruktion von Stirnwänden mit einer Mindestbreite von 35/40 cm ist empfehlenswert, damit die vorgefertigten Startblöcke plaziert werden können.

Für ein besseres ästhetisches Ergebnis und zur Optimierung der Zeiten und der Kosten wird eine modulare Breite und Länge der Stirnwände aus Fliesen und ganzen Formteilen empfohlen.



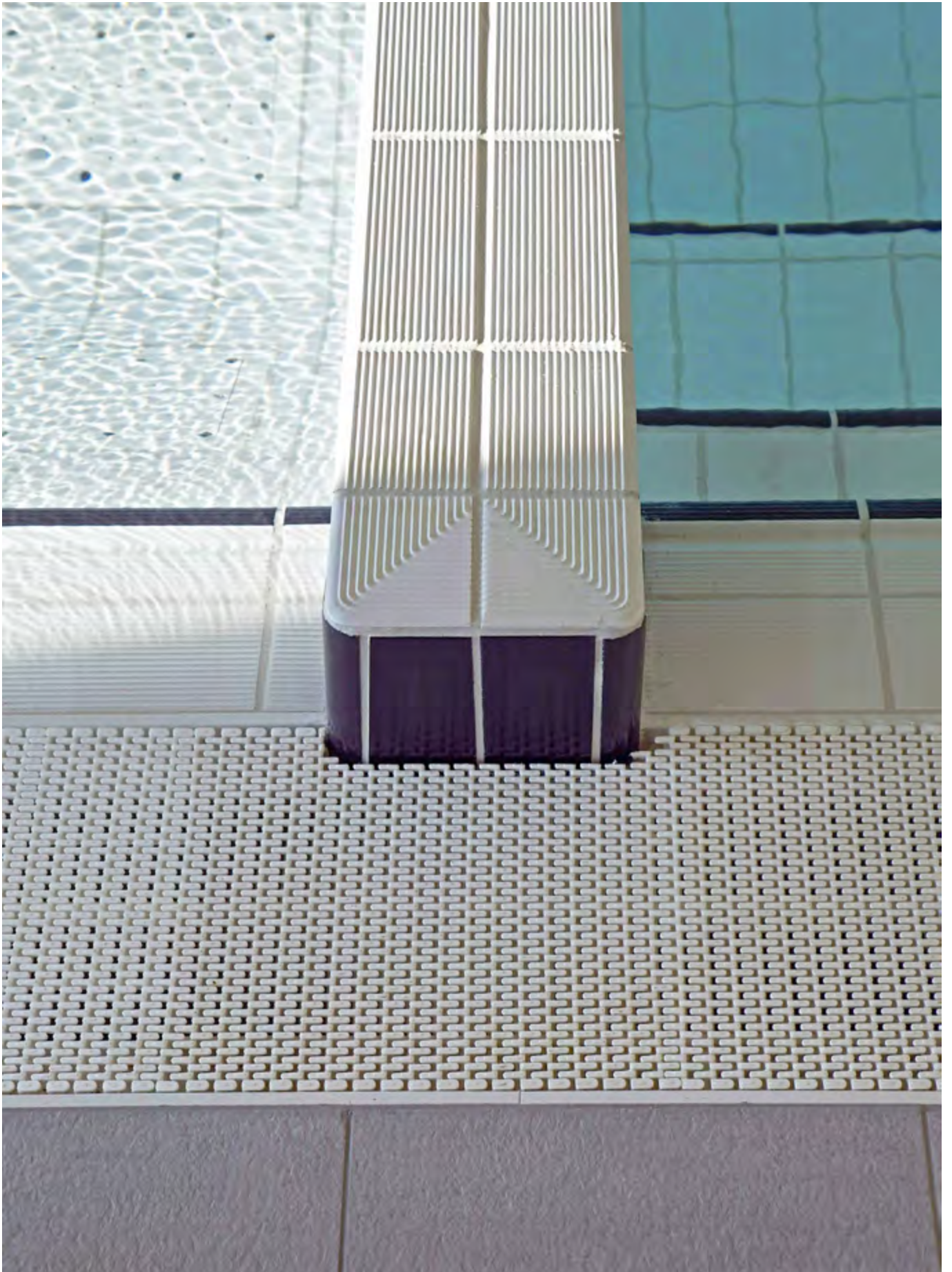

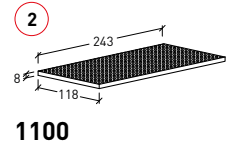
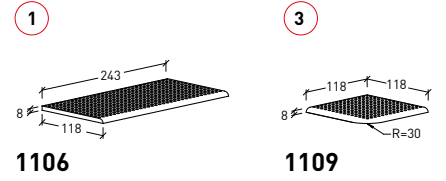
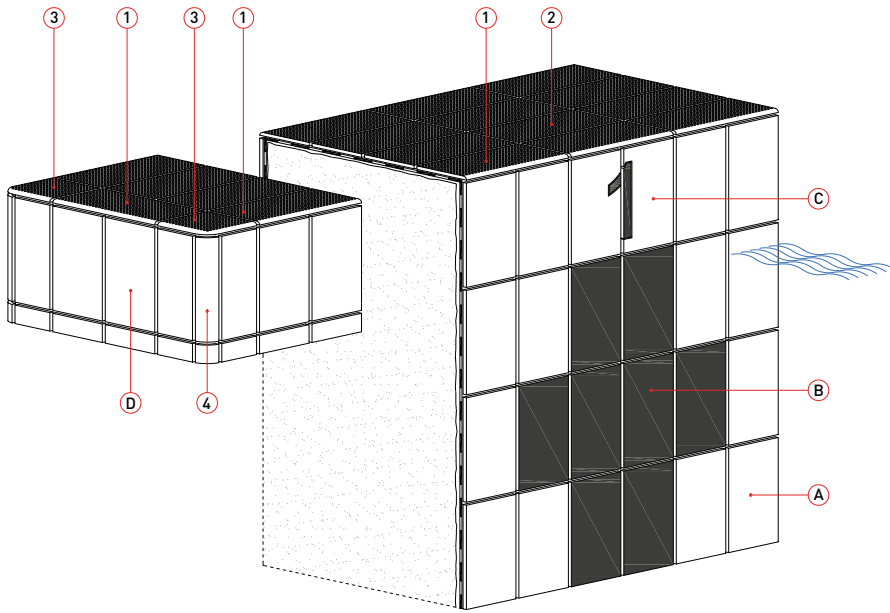

ELEMENTI - Pinhead

010 Talco	011 Avorio	021 Mare
060 Cemento	061 Basalto	070 Ebano

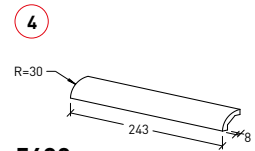

5630 LANDSCAPE - Satin

100 Tundra	200 Bay	202 Ocean
700 Lava		

mod. QD 50.4

- A** LANDSCAPE - Friction_fascia di virata / turning area / zone de virage / wendeflaeche
- B** LANDSCAPE - Friction_vie di corsa / marking lanes / ligne de nage / bahnmarkierungen
- C** LANDSCAPE_piastrelle numerate / numbered tiles / carreau numerote / nummerierte platte
- D** LANDSCAPE - Satin_rivestimento esterno / external wall / revetement exterieur / wandbekleidung

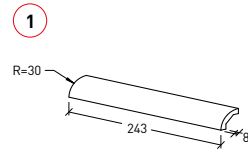
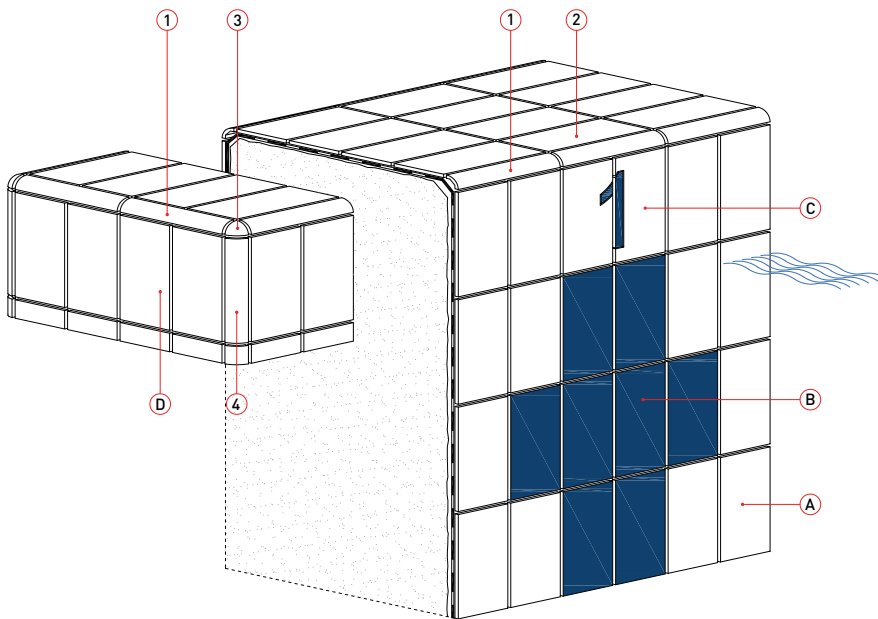

muretti di testata / starting headwalls / quais de départ / stirnwände

**5630**

LANDSCAPE - Grip

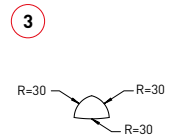
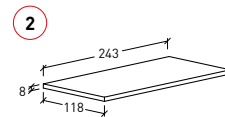
**5607****1100**

LANDSCAPE - Grip

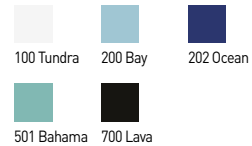
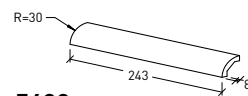
**4****5630**

LANDSCAPE - Satin

**mod. QD 56.0**

- A** LANDSCAPE - Friction_fascia di virata / turning area / zone de virage / wendeflaeche
B LANDSCAPE - Friction_vie di corsa / marking lanes / ligne de nage / bahnmarkierungen
C LANDSCAPE_piastrelle numerate / numbered tiles / carreau numerote / nummerierte platte
D LANDSCAPE - Satin_rivestimento esterno / external wall / revetement exterior / wandbekleidung



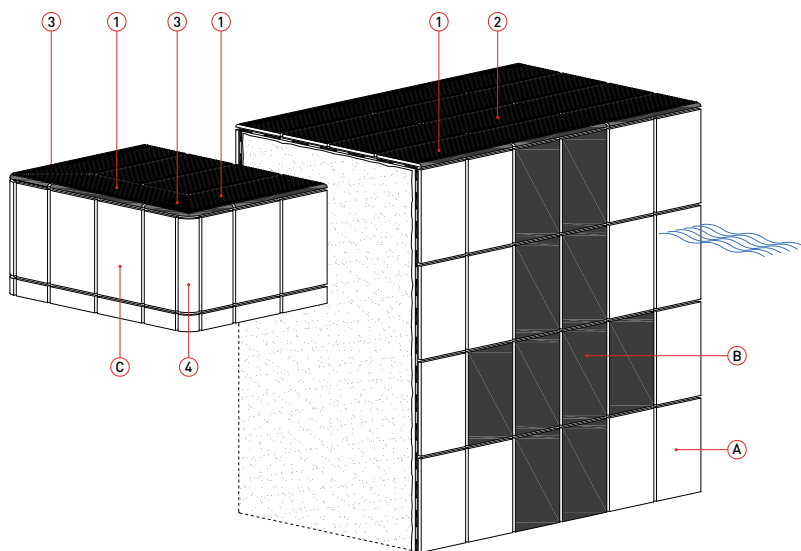

mod.QD 50.8

- A** LANDSCAPE - Friction_fascia di virata / turning area / zone de virage / wendeflaeche
- B** LANDSCAPE - Friction_vie di corsa / marking lanes / ligne de nage / bahnamarkierungen
- C** LANDSCAPE - Satin_rivestimento esterno / external wall / revetement exterieur / wandbekleidung

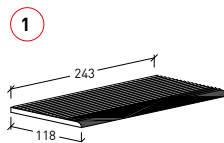

3346 Banda Nera

LANDSCAPE - Rigata



ELEMENTI - Rigata

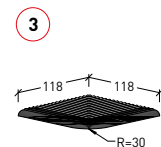

3349 Banda Nera

LANDSCAPE - Rigata



ELEMENTI - Rigata

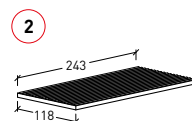

3200

LANDSCAPE - Rigata



ELEMENTI - Rigata

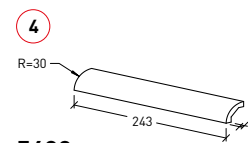

5630

LANDSCAPE - Satin



muretti di testata / starting headwalls / quais de départ / stirnwände

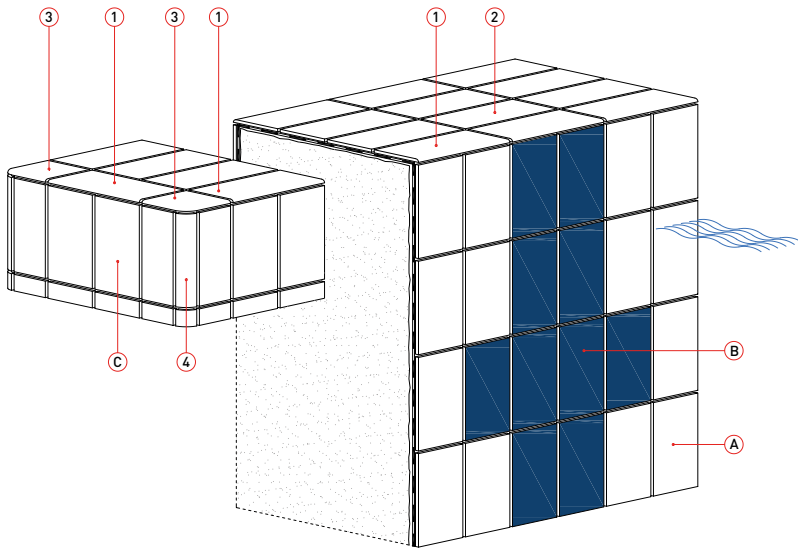

mod. QD 50.9

- A LANDSCAPE - Friction_fascia di virata / turning area / zone de virage / wendeflaeche
- B LANDSCAPE - Friction_vie di corsa / marking lanes / ligne de nage / bahnmkierungen
- C LANDSCAPE - Satin_rivestimento esterno / external wall / revetement exterieur / wandbekleidung

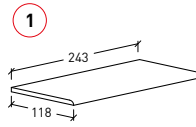

1106

LANDSCAPE - Grip

- 100 Tundra
- 200 Bay
- 202 Ocean
- 700 Lava

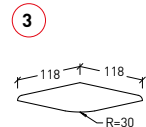

1109

LANDSCAPE - Grip

- 100 Tundra
- 200 Bay
- 202 Ocean
- 700 Lava

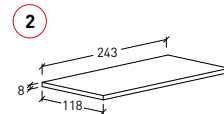

1100

LANDSCAPE - Grip

- 100 Tundra
- 200 Bay
- 202 Ocean
- 501 Bahama
- 700 Lava

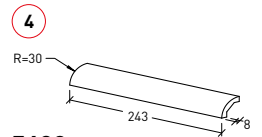

5630

LANDSCAPE - Satin

- 100 Tundra
- 200 Bay
- 202 Ocean
- 700 Lava



Scale e gradini

STAIRS AND STEPS
ESCALIERS ET MARCHES
TREPPEN UND STUFEN

La normativa esige che le scale e i gradini degli impianti natatori abbiano una superficie con un grado di antiscivolosità a piedi nudi di gruppo B quando sono esterni alle vasche e di gruppo C quando sono immersi in acqua.

Per ragioni di sicurezza si deve sempre evitare la presenza di spigoli vivi o taglienti e, per le scale immerse in acqua, è necessario sempre prevedere strisce di colore a contrasto sulla parte terminale delle pedate per evidenziare il cambio di profondità tra un gradino e l'altro.

L'ampia gamma di pezzi speciali e di tipologie di superfici permette di realizzare moduli con pedate di 25 cm, 27,5 cm, 30 cm, 37,5 cm e 50 cm senza necessità di operare nessun taglio.

In public pools, the regulation recommends that stairs and steps have a group B barefoot non-slip surface coefficient if they are located outside of water and group C when immersed into water.

For security reasons when it comes to submerged stairs, it is also very important to avoid sharp edges and to provide for contrasting colour stripes on the end-portion of the steps in order to signal the change of depth between one and the next.

The wide range of fittings and available surface types allows for steps of 25 cm, 27.5 cm, 30 cm, 37.5 cm and 50 cm without any cut.

Dans les piscines recevant du public, la norme prévoit que les escaliers et les marches aient une surface antidérapante pieds nus de group B s'ils sont situés hors d'eau et de group C quand immergés dans l'eau.

Pour des raisons de sécurité il est aussi très important d'éviter les arêtes vives et, en ce qui concerne les escaliers plongés dans l'eau, de réaliser les nez-de-marche avec marquage de sécurité pour mieux voir la différence de profondeur.

L'ample gamme des pièces spéciales et des surfaces disponibles permet de réaliser des marches de 25 cm, 27,5 cm, 30 cm, 37,5 cm et 50 cm sans aucune coupe.

Die Bestimmungen fordern, dass die sich außerhalb der Becken befindenden Treppen und Stufen der Schwimmanlagen eine Oberfläche mit einem Rutschfestigkeitskoeffizienten der Gruppe B bei barfüßigem Betreten haben müssen, während die unter Wasser liegenden Treppen und Stufen einen Rutschfestigkeitskoeffizienten der Gruppe C aufweisen müssen.

Aus Sicherheitsgründen sind scharfe oder schneidende Kanten stets zu vermeiden, und bei den Unterwassertreppen müssen die Enden der Trittstufen immer mit kontrastierenden Farbstreifen versehen sein, um die Tiefenänderung zwischen beiden Stufen hervorzuheben.

Das breite Sortiment an Formteilen und Oberflächenausführungen ermöglicht die Konstruktion von Teilen mit Trittstufen von 25 cm, 27,5 cm, 30 cm, 37,5 cm und 50 cm, ohne dabei Schnitte vornehmen zu müssen.

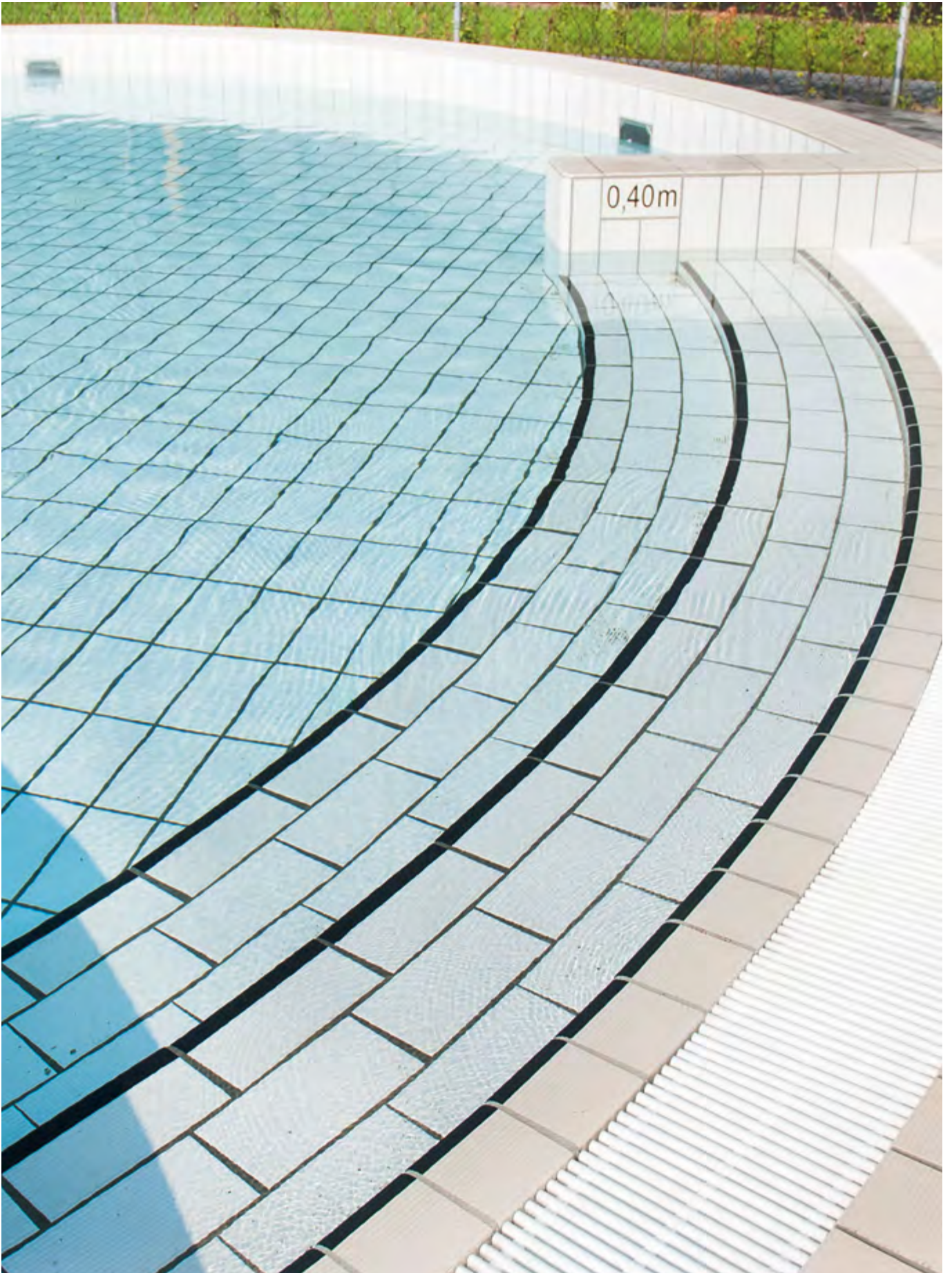

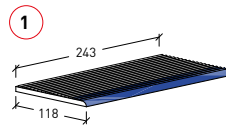
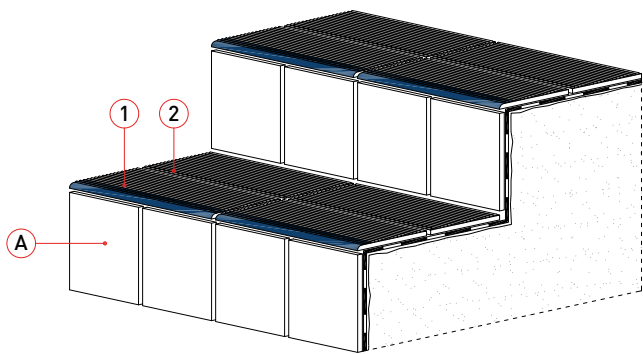

3346 Banda Blu

LANDSCAPE - Rigata

100 Tundra

ELEMENTI - Rigata

010 Talco

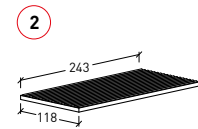

3200

LANDSCAPE - Rigata

100 Tundra 202 Ocean

ELEMENTI - Rigata

010 Talco 011 Avorio

mod. SC 25.0

A LANDSCAPE - Satin / ELEMENTI - Matt_alzata / riser / contremarche / setzstufe

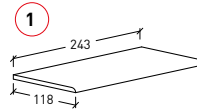
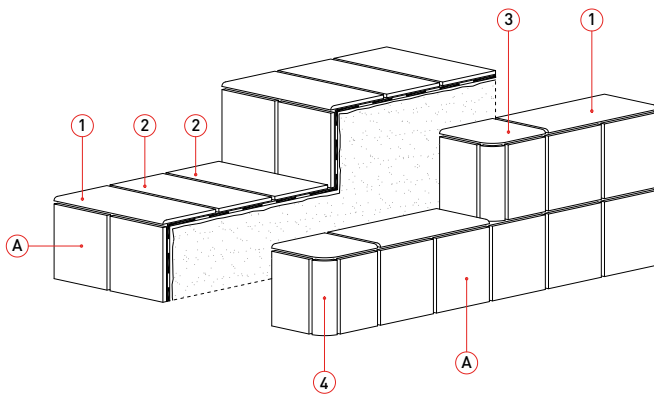

1106

LANDSCAPE - Grip

100 Tundra 200 Bay 202 Ocean

700 Lava

ELEMENTI - Matt

010 Talco 011 Avorio 021 Mare

060 Cemento 061 Basalto 070 Ebano

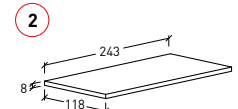

1100

LANDSCAPE - Grip

100 Tundra 200 Bay 202 Ocean

501 Bahama 700 Lava

ELEMENTI - Matt

010 Talco 011 Avorio 021 Mare

060 Cemento 061 Basalto 070 Ebano

mod. SC 37.0

A LANDSCAPE - Satin / ELEMENTI - Matt_alzata / riser / contremarche / setzstufe

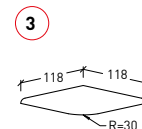

1109

LANDSCAPE - Grip

100 Tundra 200 Bay 202 Ocean

700 Lava

ELEMENTI - Matt

010 Talco 011 Avorio 021 Mare

060 Cemento 061 Basalto 070 Ebano

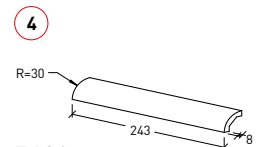

5630

LANDSCAPE - Satin

100 Tundra 200 Bay 202 Ocean

700 Lava

ELEMENTI - Matt

010 Talco 011 Avorio 060 Cemento

scale e gradini / stairs and steps / escaliers et marches / treppen und stufen

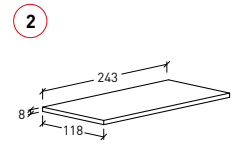
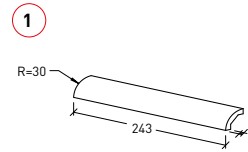
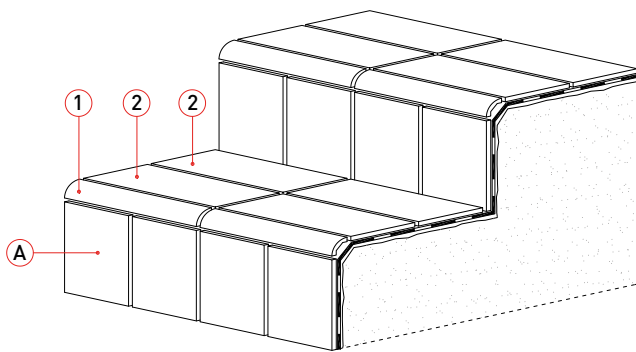

5630

LANDSCAPE - Grip





- 
 100 Tundra
- 
 202 Ocean
- 
 700 Lava

ELEMENTI - Matt







- 
 010 Talco
- 
 011 Avorio
- 
 060 Cemento

1100

LANDSCAPE - Grip

- 
 100 Tundra
 - 
 200 Bay
 - 
 202 Ocean
- 
 501 Bahama
 - 
 700 Lava

ELEMENTI - Matt

- 
 010 Talco
 - 
 011 Avorio
 - 
 021 Mare
- 
 060 Cemento
 - 
 061 Basalto
 - 
 070 Ebano

mod. SC 27.2

A LANDSCAPE - Satin / ELEMENTI - Matt_alzata / riser / contremarche / setzstufe

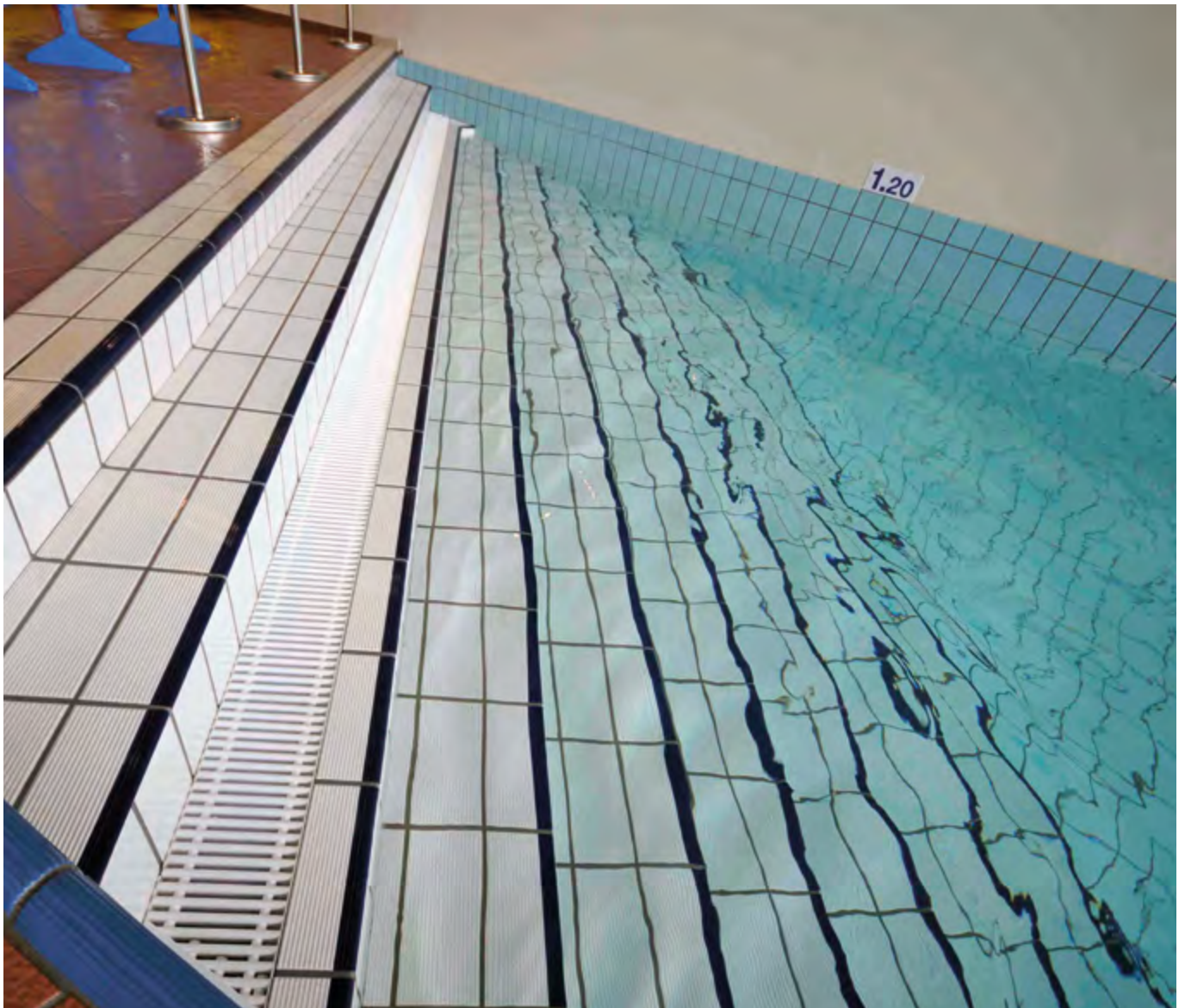

Gradini di riposo

RESTING STEPS
REPOSE PIEDS
RASTSTUFEN

La normativa FINA prevede la possibilità di avere superfici di appoggio (gradini di riposo) situati lungo una o più pareti della vasca ad un minimo di 1,20 m. sotto il livello dell'acqua e con una larghezza variabile fra 10 cm e 15 cm.

Per ragioni di sicurezza è consigliabile che i gradini di riposo abbiano una superficie antiscivolo, siano di un colore a contrasto ed abbiano il bordo arrotondato.

Nel caso di vasche dedicate alla pallanuoto è richiesto che il gradino di riposo sia incassato nella parete.

The FINA standard allows to build supporting structures (resting steps) on one or more walls of the pool at a minimum depth of 1.20 meters below water level, with a width from 10 cm to 15 cm.

For security reasons it is very important that the footrest have a non-slip surface, a contrasting colour from the walls of the pool and rounded edges.

For water polo pools, it is necessary that the footrests be recessed into the walls.

Les normes de la FINA autorisent la réalisation d'une marche pour s'appuyer (repose-pieds) sur une ou plusieurs parois du bassin à 1,20 mètres de profondeur minimum, avec une largeur de 10 cm à 15 cm.

Pour des raisons de sécurité il est très important que les repose-pieds aient une surface antidérapante, de groupe C avec bord arrondi et marquage de sécurité.

En cas de bassins de water-polo, il faut que les repose-pieds soient encastrés dans les parois.

Die FINA-Bestimmungen sehen die Konstruktionsmöglichkeit verschiedener Stützflächen (Raststufen) entlang einer Beckenwand oder mehrerer Beckenwände mindestens 1,20 m unter dem Wasserspiegel und mit einer variablen Breite zwischen 10 cm und 15 cm vor.

Aus Sicherheitsgründen ist es empfehlenswert, dass die Raststufen eine rutschfeste Oberfläche haben, mit einer Kontrastfarbe gekennzeichnet sind und eine abgerundete Kante aufweisen.

Bei für den Wasserball bestimmten Schwimmbecken muss die Raststufe in die Wand eingebaut sein.



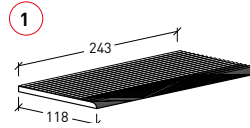
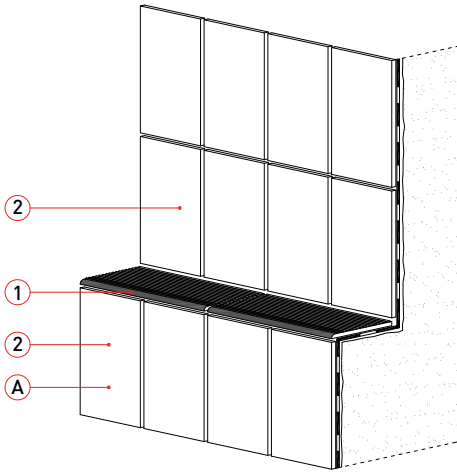

3346 Banda Nera

LANDSCAPE - Rigata



100 Tundra

ELEMENTI - Rigata



010 Talco

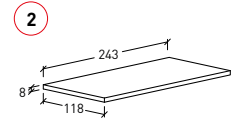

1100

LANDSCAPE - Satin



100 Tundra

200 Bay

202 Ocean

501 Bahama

700 Lava

mod. RP 013

A LANDSCAPE - Satin

interno vasca / pool tank / interieur bassin / becken

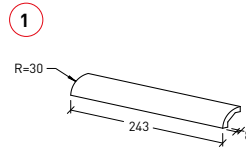
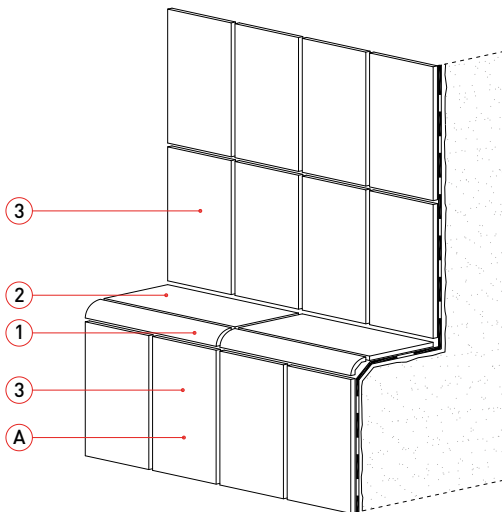

5630

LANDSCAPE - Grip



100 Tundra

202 Ocean

700 Lava

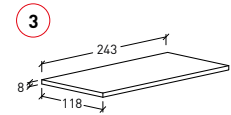

1100

LANDSCAPE - Satin



100 Tundra

200 Bay

202 Ocean

501 Bahama

700 Lava

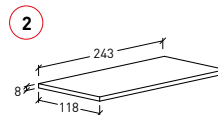

1100

LANDSCAPE - Grip



100 Tundra

200 Bay

202 Ocean

501 Bahama

700 Lava

mod. RP 008

A LANDSCAPE - Satin

interno vasca / pool tank / interieur bassin / becken

Muretti

FENCES
MURETS
MAUERN

Muretti, isole, aiuole sono complementi architettonici con funzioni estetiche e pratiche per delimitare spazi con diverse destinazioni d'uso che trovano sempre maggior gradimento nei grandi centri natatori.

Per questi elementi costruttivi è necessario evitare la presenza di spigoli vivi e creare sempre forme arrotondate e/o smussate.

Qualora le superfici orizzontali siano percorse a piedi nudi è necessario prevedere l'uso di materiali con specifica superficie antiscivolo.

Concrete fences, benches and flowerbeds are architectural elements with aesthetic and practical functions to separate spaces that have different uses. These are becoming more and more appreciated in large swimming facilities.

For these elements it is important to eliminate sharp edges by ensuring the use of rounded fittings.

In case the horizontal parts of these fences are treaded upon with bare feet, it is necessary to consider the use of non-slip ceramic tiles to prevent accidents.

Murets, jardiniers et îlots sont des compléments avec des fonctions esthétiques et pratiques de délimitation des espaces qui trouvent de plus en plus place dans les grands centres nautiques.

Pour ces éléments, il faut éliminer les arêtes vives en prévoyant le recours à des formes arrondies.

Au cas où les surfaces horizontales seraient parcourues à pieds nus, il faut également prévoir l'emploi de carreaux spécialement conçues avec fonction antidérapante.

Mauern, Inseln und Beete sind architektonische Ergänzungen mit ästhetischen und praktischen Funktionen, die der Begrenzung der Bereiche mit unterschiedlichen Verwendungszwecken dienen und die in den großen Schwimmbädern immer mehr Zuspruch finden.

An diesen Bauteilen müssen scharfe Kanten vermieden und stets gerundete und/oder abgekantete Formen verwendet werden.

Werden die waagerechten Flächen barfuß betreten, sind Materialien mit einer spezifischen rutschfesten Oberfläche zu verwenden.

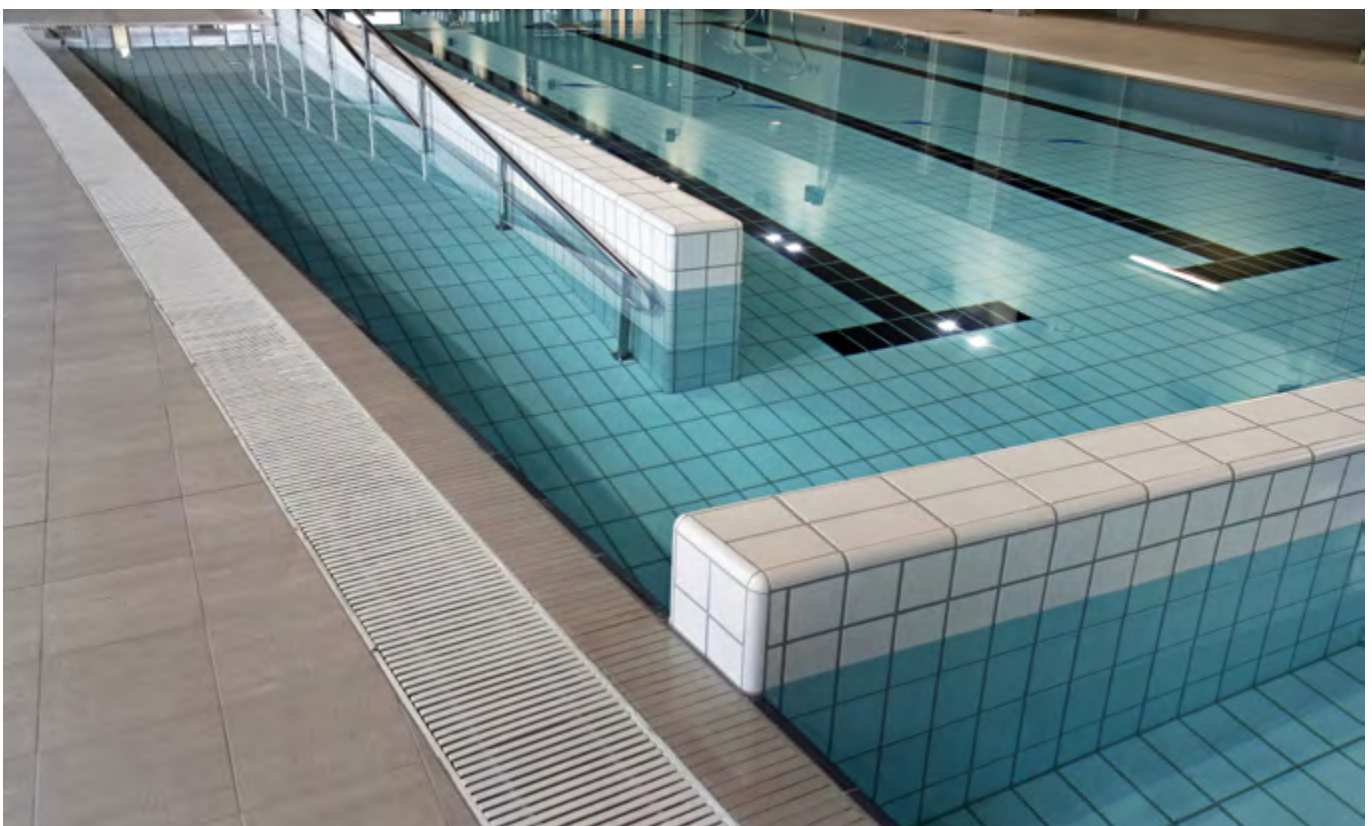

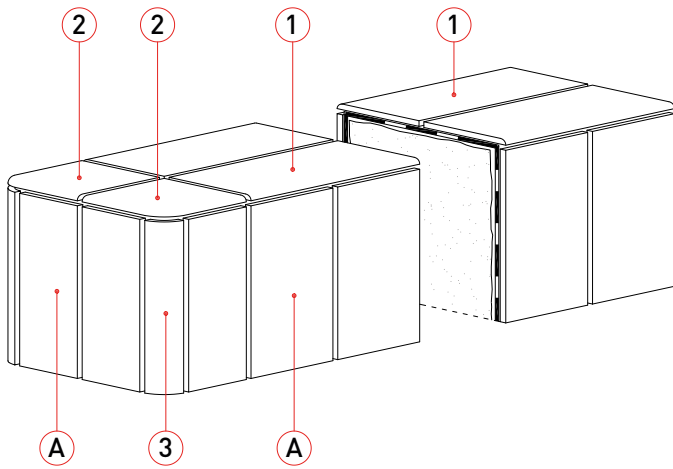

mod. MU 25.0

A LANDSCAPE - Satin_rivestimento / wall tiling / revetement / wandfliesen

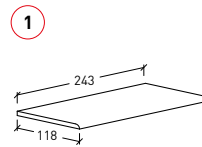

1106

LANDSCAPE - Satin



ELEMENTI - Matt

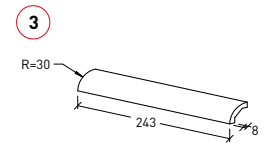
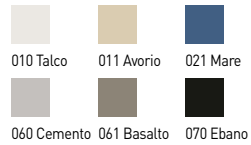

5630

LANDSCAPE - Satin



LANDSCAPE - Grip



ELEMENTI - Matt

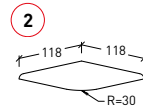

1109

LANDSCAPE - Satin



LANDSCAPE - Grip

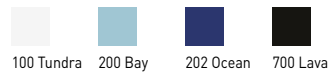

ELEMENTI - Matt

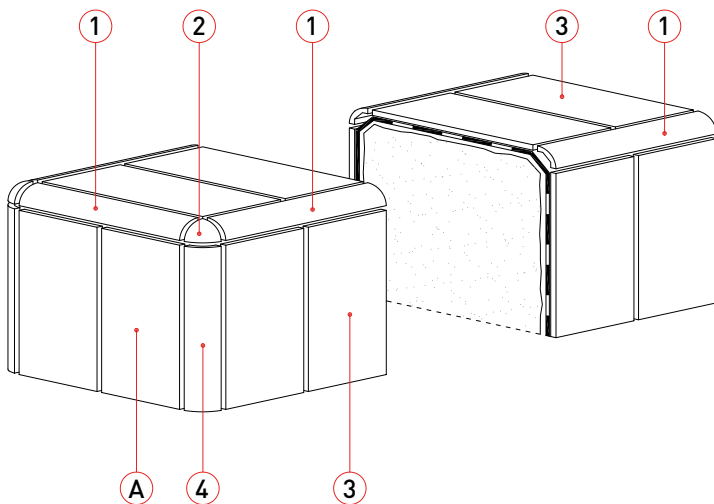
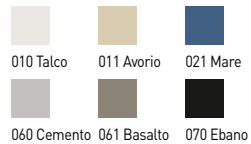

mod. MU 25.4

A LANDSCAPE - Satin_rivestimento / wall tiling / revetement / wandfliesen

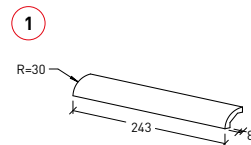

5630

LANDSCAPE - Grip

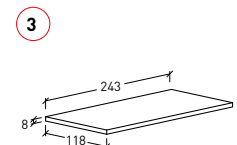

1100

LANDSCAPE - Grip

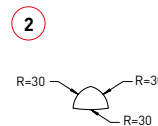
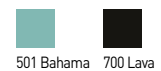

5607

LANDSCAPE - Grip

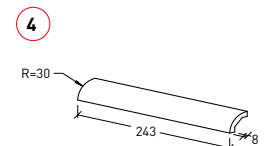

5630

LANDSCAPE - Satin

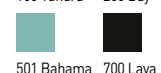

Angoli e spigoli

IN CORNERS AND OUT CORNERS
 ANGLES SORTANTS ET RENTRANTS
 ECKEN UND KANTEN

Nelle piscine, impianti natatori e nei locali accessori è opportuno, se non addirittura necessario, che ogni elemento architettonico abbia sagome e forme sempre arrotondate.

Questo consente di prevenire possibili incidenti dovuti a spigoli vivi e di facilitare le operazioni di pulizia e disinfezione nel caso di angoli.

Pools, swimming facilities and adjacent areas such as showers and locker rooms usually require the use of rounded profiles to avoid accidents due to sharp edges in case of out-corners and simplify cleaning and disinfection in case of in-corners.

Les piscines, les installations de natation et les locaux accessoires exigent le recours à des formes et des profils arrondis, ce qui permet d'éviter tout accident imputable aux arêtes vives et de simplifier le nettoyage et la désinfection de celles-ci.

In den Schwimmbädern, den Schwimmanlagen und den Nebenräumen ist es angemessen, wenn nicht sogar notwendig, dass ein jedes architektonisches Element stets abgerundete Profile und Formen hat.

Das ermöglicht die Vermeidungen von Unfällen, die durch scharfe Kanten verursacht werden, und erleichtert die Reinigung und Desinfektion der Ecken.

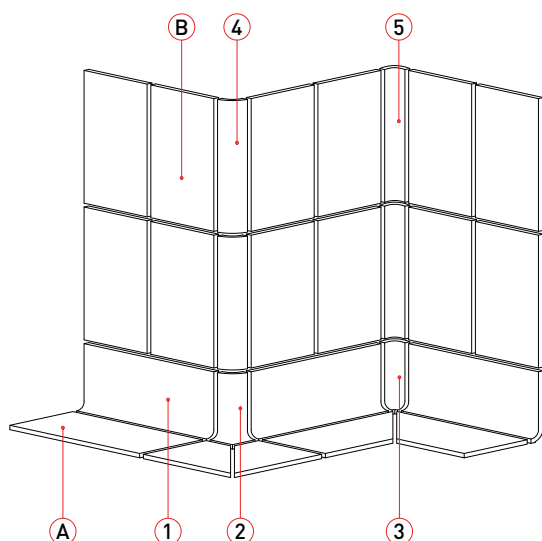

mod. FI 023

- A ELEMENTI - Matt/Pinhead_pavimento / floor / carrelage de sol / bodenfliesen
- B LANDSCAPE - Satin_rivestimento / wall tiling / revetement / wandfliesen

1

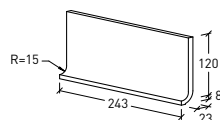

4200

LANDSCAPE - Satin



100 Tundra

2

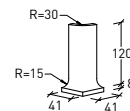

4227

3

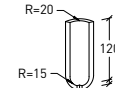

4228

4

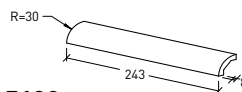

5630

LANDSCAPE - Satin



100 Tundra



200 Bay



202 Ocean



700 Lava

5

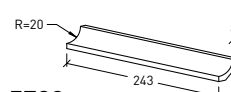

5730

angoli e spigoli / in corners and out corners / angles sortants et rentrants / kanten und ecken

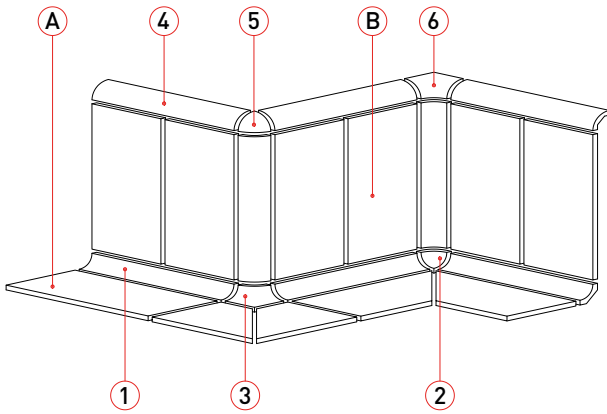

mod. FI 021

- A ELEMENTI - Matt/Pinhead_pavimento / floor / carrelage de sol / bodenfliesen
- B LANDSCAPE - Satin_rivestimento / wall tiling / revetement / wandfliesen

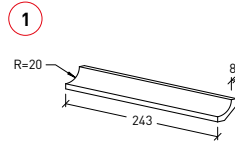

5730

LANDSCAPE - Satin

- 100 Tundra
- 202 Ocean
- 700 Lava

ELEMENTI - Matt

- 010 Talco
- 011 Avorio
- 060 Cemento

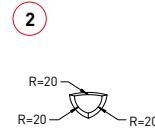

5603

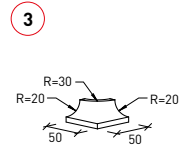

5604

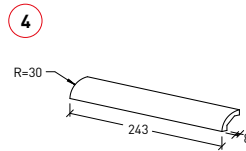

5630

LANDSCAPE - Satin

- 100 Tundra
- 202 Ocean
- 700 Lava

ELEMENTI - Matt

- 010 Talco
- 011 Avorio
- 060 Cemento

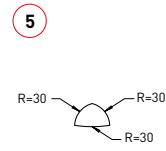

5607

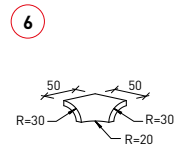

5608

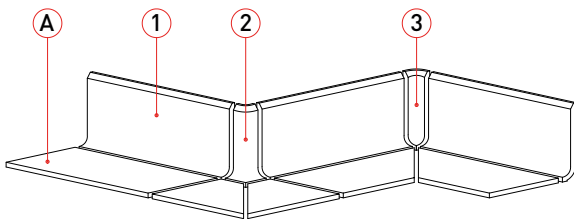

mod. FI 001

- A ELEMENTI - Matt/Pinhead_pavimento / floor / carrelage de sol / bodenfliesen

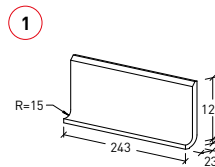

4100

LANDSCAPE - Satin

- 100 Tundra

ELEMENTI - Matt

- 010 Talco
- 060 Cemento

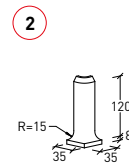

4127

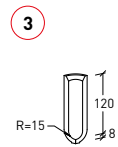

4128

Vasche lavapiedi

FEET WASHERS
PEDILUVES
DURCHSCHREITBECKEN

I regolamenti sanitari e di igiene delle piscine pubbliche obbligano l'accesso alle vasche unicamente attraverso vaschette lava piedi che hanno in genere profondità variabile dai 10 ai 20 cm.

Queste possono essere di tipo tradizionale, cioè incassate nel pavimento, oppure a conca con accesso facilitato per permettere l'attraversamento anche ai disabili motori muniti di carrozzine.

Il livello dell'acqua è generalmente mantenuto costante lasciando traboccare l'eccesso in una canaletta o in una apposita piletta.

Il fondo di queste vasche deve essere realizzato con materiale antiscivolo di gruppo C a piedi nudi.

Sanitary measures oblige access to public pools through feet washers to clean and disinfect feet of users. The depth of feet washers is normally between 10 and 20 cm.

These feet washers may be conventional, i.e. embedded in the floor, or as a curved hollow to enable access to users on wheelchairs too.

The water level is normally kept by a system of overflow that leave excess water to flow in a suitable channel or water outlet.

The bottom of these feet washer has to be done with Group C barefoot non-slip tiles.

Les mesures sanitaires prévoient que l'accès aux bassins des piscines publiques passe obligatoirement par des pédiluves afin de nettoyer et désinfecter les pieds. La profondeur des pédiluves est normalement entre 10 cm et 20 cm.

Ces pédiluves peuvent être de type traditionnel, à savoir encastrés dans la plage, ou à pentes inversées normalisées à 5% maximales avec accès facilité pour les personnes en fauteuil roulant.

Le niveau de l'eau est normalement gardé par un système de trop-plein avec caniveau ou bonde spécifique.

Le fond des pédiluves doit être réalisé avec des carreaux antidérapants pieds nus de groupe C.

Die sanitären und hygienischen Bestimmungen für öffentliche Schwimmbäder machen einen ausschließlichen Zugang zu den Schwimmbecken über Durchschreitbecken mit einer allgemeinen Tiefe zwischen 10 und 20 cm obligatorisch.

Diese können traditioneller Art, d.h. in den Fußboden eingebaut, oder muldenförmig sein, um somit auch den Zugang für motorisch behinderte Personen im Rollstuhl zu erleichtern.

Der Wasserspiegel wird im Allgemeinen konstant gehalten und das überschüssige Wasser läuft in eine Rinne oder in einen eigens dazu vorgesehenen Beckenauslauf ab.

Der Boden dieser Becken muss aus rutschfestem Material der Gruppe C bei barfußigem Betreten sein.



vasche lavapiedi / feet washers / pédiluves / durchschreitbecken

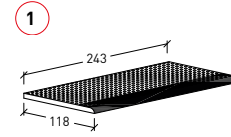
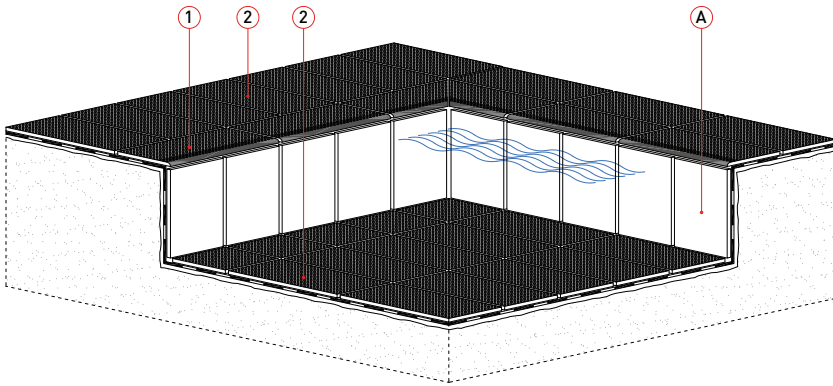

3356 Banda Nera

ELEMENTI - Pinhead

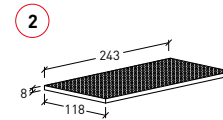

1100

ELEMENTI - Pinhead

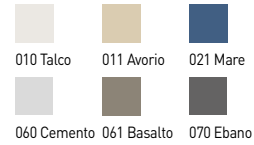

mod. PE 005

A LANDSCAPE - Satin / ELEMENTI - Matt_rivestimento / wall tiling / revetement / wandfliesen

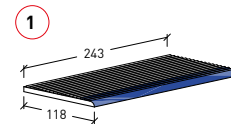
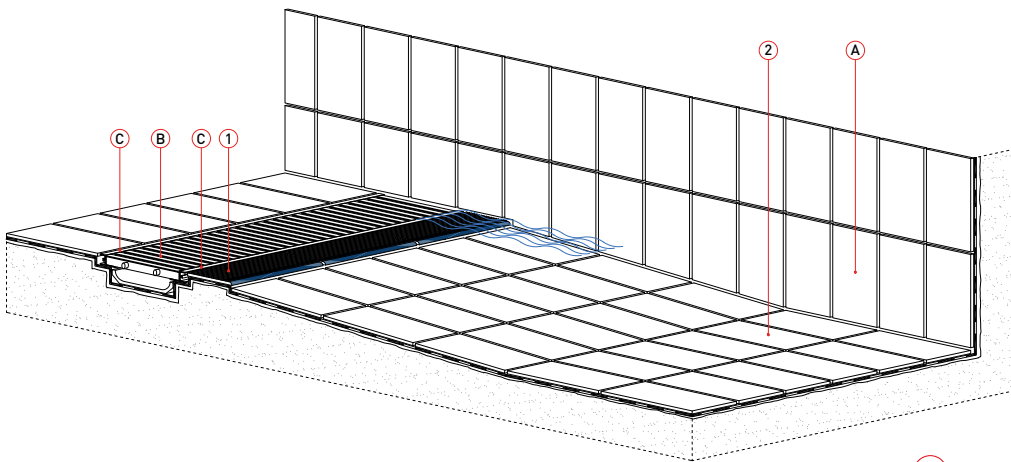

3346 Banda Blu

LANDSCAPE - Rigata

ELEMENTI - Rigata

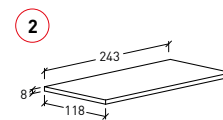

1100

LANDSCAPE - Grip



mod. PE 006

A LANDSCAPE - Satin_rivestimento / wall tiling / revetement / wandfliesen

B PADANA GRID_griglia in pvc / grating in pvc / grille en pvc / pvc rost

C PADANA GRID_angolare in pvc / pvc grating support / corniere en pvc / pvc rost traeger

Panche e sedute

SITTING AND LAYING BENCHES
BANQUETTES
BÄNKE UND LIEGEN

La presenza di vasche ricreative o ludiche è sempre più frequente negli impianti natatori per offrire momenti di svago e relax agli utenti.

Per consentire di godere appieno degli effetti rilassanti e tonificanti dell'acqua queste vasche vengono poi corredate con diversi tipi di getti massaggianti e da sdrai e/o sedute immerse nell'acqua.

Diventa pertanto preferibile ed opportuno che questi elementi costruttivi abbiano forme ergonomiche che favoriscano il confort e che assicurino finiture arrotondate per prevenire gli infortuni.

Recreational and fun pools are becoming more popular in swimming facilities to provide relaxation and leisure to users.

To help take full advantage of the toning and relaxing effects of water, these pools are equipped with various water jets, underwater deckchairs and seats.

It is therefore advisable that the structures of these elements be, wherever possible, ergonomic in order to ensure the comfort of bathers and with rounded edges to prevent accidents.

Les bassins récréatifs ou ludiques sont de plus en plus nombreux dans les installations de natation pour offrir des moments de détente et relaxation aux usagers.

Pour permettre de bénéficier pleinement des effets tonifiants et relaxants de l'eau, ces bassins sont équipés de différentes buses d'hydro-massage et/ou de banquettes plongées dans l'eau.

Il est donc recommandable que les structures de ces éléments soient, dans la mesure du possible, ergonomiques pour le confort des baigneurs et avec des arêtes arrondies pour prévenir les accidents.

Man findet immer häufiger Spiel- und Freizeitbecken in den Schwimmanlagen, die den Badegästen Momente der Erholung und Entspannung ermöglichen.

Damit die entspannende und belebende Wirkung des Wassers voll ausgeschöpft werden kann, sind diese Becken mit verschiedenen Arten von Schwallstrahlen und mit Liegen und/oder Sitzgelegenheiten unter Wasser ausgestattet.

Diese Bauteile sollten daher möglichst und zweckmäßigerweise ergonomische Formen haben, die den Komfort begünstigen und abgerundete Oberflächenausführungen zur Unfallvermeidung gewährleisten.



panche e sedute / sitting and laying benches / banquettes / bänke und liegen

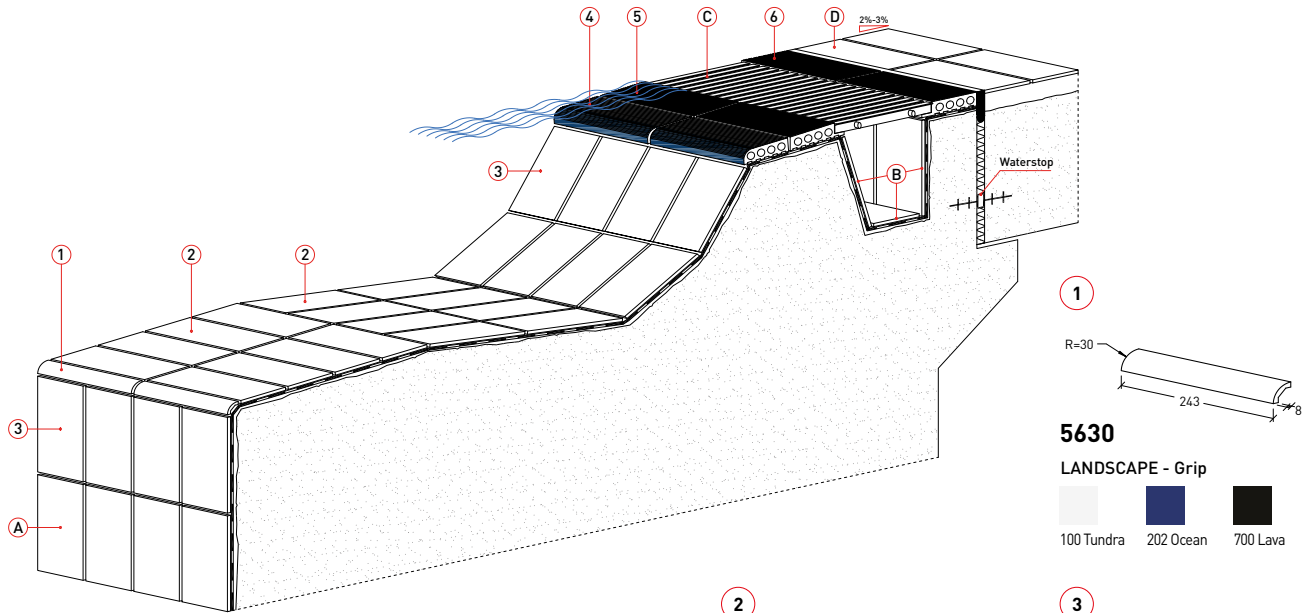

BR 004

- A LANDSCAPE - Satin_interno vasca / pool tank / interieur bassin / becken
- B LANDSCAPE - Satin_canaletta di ricircolo / overflow channel / caniveau eau bassin / rinne
- C PADANA GRID_griglia in pvc / grating in pvc / grille en pvc / pvc rost
- D ELEMENTI - Matt/Pinhead_esterno vasca / pool surround / plage / beckenumgang

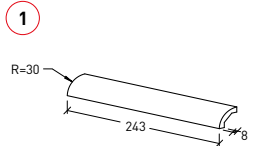

5630
LANDSCAPE - Grip
100 Tundra 202 Ocean 700 Lava

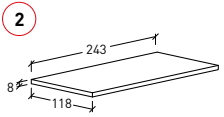

1100
LANDSCAPE - Friction
100 Tundra 200 Bay 202 Ocean
501 Bahama 700 Lava

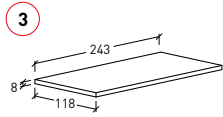

1100
LANDSCAPE - Satin
100 Tundra 200 Bay 202 Ocean
501 Bahama 700 Lava

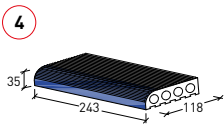

9046 Banda Blu
Trim-Box
LANDSCAPE - Rigata**
100 Tundra

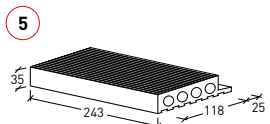

8800
Trim-Box
LANDSCAPE - Rigata**
100 Tundra

P102-0242
Polyfill cilindro / cylinder / cilindre / Zylinder
(4 pcs)*

P102-0242
Polyfill cilindro / cylinder / cilindre / Zylinder
(4 pcs)*

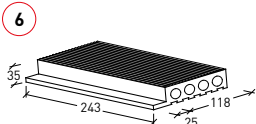

8600
Trim-Box
LANDSCAPE - Rigata**
100 Tundra

P102-0242
Polyfill cilindro / cylinder / cilindre / Zylinder
(4 pcs)*

* Vedi pagina: See page: Voir page: Siehe Seite: 36

** Colore 010 Talco su richiesta
Colour 010 Talco on request
Coloris 010 Talco sur demande
Farbe 010 Talco auf Anfrage





WELLNESS & SPA

CERAMICHE PER WELLNESS E SPA

CERAMICS FOR WELLNESS AND SPA

CERAMIQUES POUR WELLNESS ET SPA

KERAMIK FÜR WELLNESS UND SPA

Naturali come l'acqua

AS NATURAL AS WATER
NATURELLES COMME L'EAU
NATÜRLICH WIE DAS WASSER

Le aree wellness, le grandi spa ed i centri benessere sono luoghi progettati per evocare emozioni e stimoli sensoriali; i materiali dei rivestimenti diventano così i mezzi privilegiati ed eletti a creare spazi accoglienti e confortevoli dove l'acqua è protagonista con vigore energetico o rilassante pacatezza.

Casalgrande Padana ha messo a punto una selezione di prodotti in gres porcellanato dalle superfici naturali, dalla tattilità materica e dal cromatismo seducente ad alte prestazioni tecniche per resistere al continuo contatto con l'acqua e l'umidità.

Natura, comfort e benessere, ma anche sicurezza e durata nel tempo. Un solido matrimonio tra tecnologia ed estetica contemporanea che valorizza gli investimenti ed i progetti architettonici del settore wellness.

Wellness centres, large spas and thermal centres are places designed to evoke emotions and stimulate the senses; cladding materials become the privileged elements of choice to create welcoming and comfortable spaces where water is the protagonist, with energising force or relaxing calm.

Casalgrande Padana designed a range of stoneware tiles with natural, highly tactile surfaces with a very appealing colour palette and high technical performance to withstand continuous contact with water and humidity.

Nature, comfort and well being, but also safety and durability over time. That is, a strong combo between technology and contemporary aesthetics to enhance investment and architectural projects in the wellness industry.

Les centres de bien-être, de thalassothérapie et les grands spas sont des lieux conçus pour évoquer des émotions et des stimulations sensorielles ; les matériaux des revêtements deviennent ainsi des moyens privilégiés et prioritaires pour la création d'espaces accueillants et confortables où l'eau est la protagoniste, avec vigueur énergétique ou calme relaxant.

Casalgrande Padana a conçu un éventail de produits en grès cérame aux surfaces naturelles, matériques au touche et au chromatisme séduisant, garantissant des performances techniques élevées pour résister au contact continu avec l'eau et l'humidité.

Nature, confort et bien-être, mais également sécurité et résistance dans le temps. À savoir, une union solide entre technologie et esthétique contemporaine pour valoriser les investissements et les projets architecturaux du secteur du bien-être.

Die Wellnessbereiche, die großen Heilbäder und die Wellnesszentren sind Orte, die mit dem Ziel geplant werden, Gefühle zu erwecken und die Sinne anzuregen; die Materialien der Verkleidungen werden somit zu privilegierten und auserwählten Instrumenten zur Schaffung von einladenden und behaglichen Bereichen, in denen das Wasser mit energischer Kraft oder entspannter Gelassenheit die Hauptrolle spielt.

Casalgrande Padana hat eine Auswahl von Feinsteinzeugprodukten mit matten Oberflächen, materischem Tastempfinden und verführerischen Farbeffekten sowie mit hohen technischen Leistungen erstellt, damit das Produkt dem beständigen Kontakt mit Wasser und Feuchtigkeit standhalten kann.

Natürlichkeit, Komfort und Wohlbefinden, aber auch Sicherheit und langfristige Beständigkeit. Es handelt sich um eine solide Verbindung zwischen der Technologie und der zeitgenössischen Ästhetik, die die Investitionen und die architektonischen Projekte der Wellnessbranche zur Geltung bringt.



Mineral Chrom

PIETRE NATIVE

La serie Mineral Chrom, realizzata in gres fine porcellanato, è frutto di una tecnologia produttiva d'avanguardia in grado di offrire elevate prestazioni ed ampie possibilità compositive.

La texture superficiale è volutamente caratterizzata da lastre con più tonalità cromatiche e da accattivanti effetti tridimensionali in modo che, come in natura, nessuna lastra sia uguale all'altra.

Per consentirne l'impiego in aree asciutte e bagnate oppure per rivestimenti murali, tutti i colori della Serie Mineral Chrom, nei formati 30x30 cm e 30x60 cm, sono disponibili sia con superficie Soft classificata R10-B sia con superficie Naturale classificata R11-B secondo Norma DIN 51097.

Corredata con mosaici, listelli, decori e pezzi speciali di finitura Mineral Chrom diventa idonea per rivestire fondo e pareti di piscine termali, ricreative e private, esterni vasche, solarium, spogliatoi e aree accessorie.

Mineral Chrom è resistente alla flessione, all'usura, all'abrasione, agli attacchi chimici e agli sbalzi termici e pertanto è utilizzabile sia in spazi interni che esterni.

The Mineral Chrom range of fine stoneware tiles is the result of a cutting-edge production technology that provides excellent performance and a wide range of combinations.

The surface texture has been deliberately made of multi-coloured slabs and attractive three-dimensional effects so that no two slabs are identical, as it happens in nature.

In order to have the possibility to properly use Mineral Chrom products in dry and wet areas and for wall applications, all colors sized 30x30 cm and 30x60 cm are available with surface Soft rated R10-B and with surface Naturale rated R11-B according to DIN 51097 Standard.

The range includes mosaics, listellos, decors and fittings and is therefore suitable to tile bottoms and walls of thermal pools, recreational and private pools, pool decks, solariums, locker rooms and adjacent areas.

Mineral Chrom has excellent flexural strength, as well as wear, abrasion, chemical and thermal resistance, so it can be used both indoors and outdoors.

La série Mineral Chrom, réalisée en grès cérame, est le fruit d'une technologie de fabrication de pointe étant en mesure d'offrir des performances élevées et de larges possibilités de composition.

La texture superficielle est délibérément caractérisée par des dalles à plusieurs tons chromatiques et aux effets tridimensionnels captivants de sorte que, tout comme dans la nature, aucune dalle ne soit égale à l'autre.

Pour permettre le bon emploi dans les sols secs et mouillés et/ou pour les habillages muraux, toutes les teintes de la Série Mineral Chrom en format 30x30 cm et 30x60 cm sont disponibles avec finition Soft classée R10-B et finition Naturale classée R11-B selon la norme DIN 51097.

La gamme se complète avec mosaïques, listels, décorations et pièces spéciales qui permettent de réaliser piscines thermales, piscines ludiques et privées, plages de piscine, solariums, vestiaires à l'intérieur et à l'extérieur.

Mineral Chrom est résistant à la flexion, à l'usure, à l'abrasion, aux attaques chimiques et aux chocs thermiques, donc il peut être utilisé aussi bien à l'extérieur qu'à l'intérieur.

Die Serie Mineral Chrom aus Feinsteinzeug ist das Ergebnis einer fortschrittlichen Produktionstechnologie, die hohe Leistungen und umfangreiche Kombinationsmöglichkeiten bietet.

Für die Oberflächentextur wurden bewusst Platten mit mehreren Farbtönen und mit attraktiven dreidimensionalen Wirkungen entwickelt, damit genauso wie in der Natur keine Platte der anderen gleicht.

Alle Farben der Serie Mineral Chrom, in den Formaten 30x30 cm und 30x60 cm, sind in der Oberfläche Soft (R10-B) und Naturale (R11-B) erhaltbar. Dies ermöglicht die Verwendung dieser Platten in Trocken- und Nassbereiche oder als Wandbekleidung.

Ausgestattet mit Mosaiken, Listellos, Dekoren und Formstücken, die Serie Mineral Chrom ist sowohl für die Boden- und Wandverlegung von Thermalbädern, Freizeit- und Privatschwimmbädern, als auch für Freibäder, Sonnenbereiche, Umkleide- und Nebenräume geeignet.

Mineral Chrom ist biegefest und beständig gegen Verschleiß, Abrieb, Chemikalien, Temperaturschwankungen und kann somit sowohl in Innen- wie auch Außenbereichen eingesetzt werden.



soft



naturale



● Soft ⁽¹⁾

DIN 51097 B	XP P 05-010 PN 18	
DIN 51130 R 10	XP P 05-010 PC 10	

Formati Sizes
Formats Formate

Spessori Thicknesses
Epaisseurs Stärken

Superfici Surfaces
Surfaces Oberflächen



cm 30x30
11^{3/4}" x 11^{3/4}"

mm 9



cm 30x60
11^{3/4}" x 23^{5/8}"

mm 9



● Naturale ⁽²⁾

DIN 51097 B	XP P 05-010 PN 18	
DIN 51130 R 11	XP P 05-010 PC 20	

Rettificate in un unico calibro Rectified version in a single caliber Rectifiés en un unique calibre Boden Sie in einem einzigen Kaliber

⁽¹⁾ A pavimento: zone asciutte Floor: dry zones Revêtement de sol : zones sèches Boden: trokenzonen

⁽²⁾ A pavimento: zone asciutte e zone umide Floor: dry zones and wet zones Revêtement de sol : zones sèches et zones humides
Boden: trokenzonen und feuchtzonen

Caratteristiche tecniche a pagina: Technical features on page: Caractéristiques techniques à la page: Technische Eigenschaften auf Seite: 207

MINERAL CHROM

Mineral White



Mineral Grey



Mineral Black

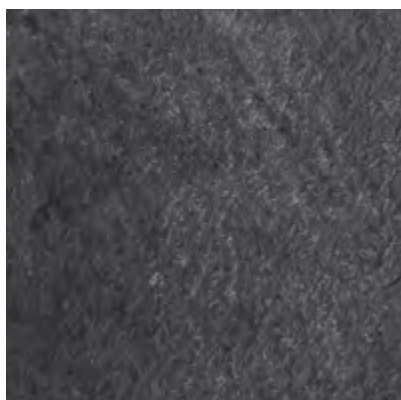

Mineral Beige



Mineral Gold



Mineral Brown



Accentuata
Heavy mixed
Fortement
Starkes

Vedi pagina: See page: Voir page: Siehe Seite: **209**



MINERAL CHROM

MOSAICI*

Mosaico Mineral 3x3 cm



30x30 cm 11³/₄"x11³/₄"
3x3 cm 1¹/₈"x1¹/₈"

Standard su rete
Standard on net
Standard sur trame
Standard auf Netz

Su richiesta con rete davanti
On demand with net on front side
Sur demande avec trame sulla belle face
Auf Anfrage mit Netz auf Vorderseite

Mosaico Mineral 6x6 cm



30x30 cm 11³/₄"x11³/₄"
6x6 cm 2³/₈"x2³/₈"

Standard su rete
Standard on net
Standard sur trame
Standard auf Netz

Su richiesta con rete davanti
On demand with net on front side
Sur demande avec trame sulla belle face
Auf Anfrage mit Netz auf Vorderseite

Vedi dettagli a pagina: See details on page: Voir détails à la page: Siehe Details auf Seite: 210

DECORI**

Composizione A



30x60 cm 11³/₄"x23⁵/₈"
Su rete On net Sur trame Auf Netz

GRIGLIE CERAMICHE***

Art. 9842

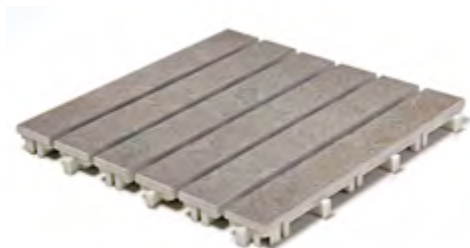

PIASTRELLE NUMERATE*

Art. D400

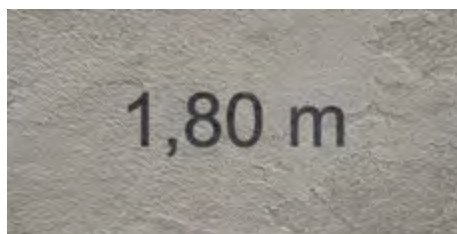

* Disponibile in tutti i colori della serie, superficie Naturale e Soft Available in all the colours of the series, Naturale and Soft surface Disponible dans toutes les couleurs de la série, surface Naturale et Soft Verfügbar in allen Farben, Naturale und Soft Oberfläche

** Disponibile in tutti i colori della serie su superficie Soft Available in all the Soft colours Disponible dans toutes les couleurs pour la surface Soft Verfügbar in allen Farben der Serie, Soft Oberfläche

*** Disponibile nei colori Mineral White, Mineral Grey o Mineral Beige su superficie Naturale Available in colour Mineral White, Mineral Grey or Mineral Beige, surface Naturale Disponible dans les coloris Mineral White, Mineral Grey ou Mineral Beige en finition Naturale Erhältlich in Mineral White, Mineral Grey oder Mineral Beige in der Oberfläche Naturale



MINERAL CHROM

GRADINI E TERMINALI GRADINO STEP TREADS MARCHES ET NEZ DE MARCHE STUFEN UND TREPPENPLATTEN

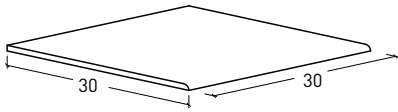

Gradino B.C. 30x30 senza righe
12 pc/box 1,8 kg/pc

MINERAL CHROM - Naturale

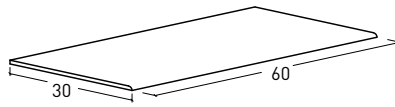

Gradino B.C. 30x60 senza righe
6 pc/box 3,89 kg/pc

MINERAL CHROM - Naturale

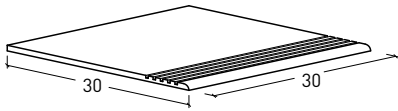

Gradino B.C. 30x30 con righe
12 pc/box 1,8 kg/pc

MINERAL CHROM - Naturale

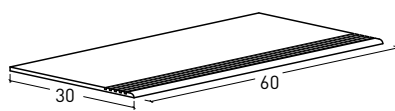

Gradino B.C. 30x60 con righe
6 pc/box 3,89 kg/pc

MINERAL CHROM - Naturale

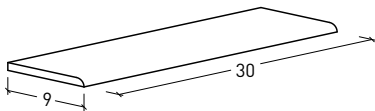

Terminale Gradino B.C. 9x30
28 pc/box 0,5 kg/pc

MINERAL CHROM* - Naturale

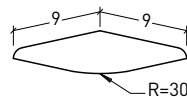
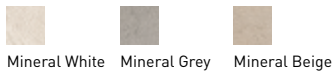

9900 Angolo Terminale Gradino B.C. 9x9
10 pc/box 0,2 kg/pc

MINERAL CHROM* - Naturale / Soft



BATTISCOPA SKIRTING BORD ARRONDI SOCKEL

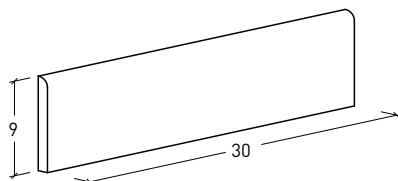

BATTISCOPA B.C. 9x30
28 pc/box 0,5 kg/pc

MINERAL CHROM - Soft



* Colori Mineral Black, Mineral Gold e Mineral Brown su richiesta Colours Mineral Black, Mineral Gold and Mineral Brown on request
Coloris Mineral Black, Mineral Gold et Mineral Brown sur demande Farben Mineral Black, Mineral Gold und Mineral Brown Auf Anfrage

PREZZI SPECIALI SUPERFICIE RIGATA (R11-C)/BORDO FINLANDESE FITTINGS SURFACE RIGATA (R11-C)/ FINLAND POOL BORDER
 PIÈCES FINITION RIGATA (R11-C) (PC20-PN24)/ TÊTE DE BASSIN FINLANDAISE FORMSTÜCKE OBERFLÄCHE RIGATA (R11-C)/BECKENKOPF FINNLAND

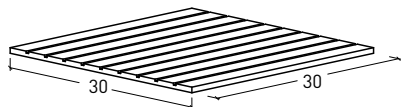

9870

12 pc/box 1,8 kg/pc

MINERAL CHROM* - Naturale

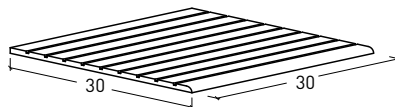
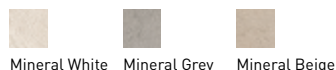

9876

12 pc/box 1,8 kg/pc

MINERAL CHROM* - Naturale

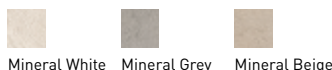

SGUSCIE E COPRI SPIGOLI COVES AND QUARTER ROUNDS GORGES ET QUARTS DE ROND HOHLKEHLEN UND RADIALLEISTEN

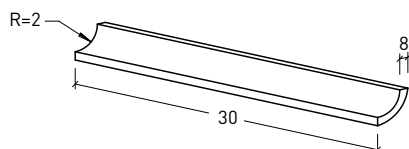

9830

48 pc/box 0,2 kg/pc

MINERAL CHROM* - Naturale

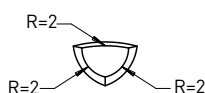

9833

10 pc/box 0,05 kg/pc

MINERAL CHROM* - Naturale

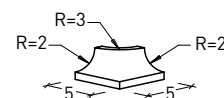
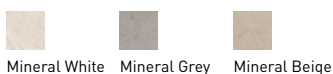

9834

10 pc/box 0,05 kg/pc

MINERAL CHROM* - Naturale

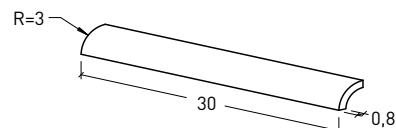

9835

48 pc/box 0,2 kg/pc

MINERAL CHROM* - Naturale

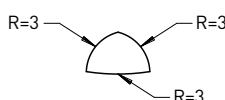

9837

10 pc/box 0,05 kg/pc

MINERAL CHROM* - Naturale

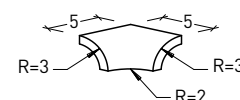
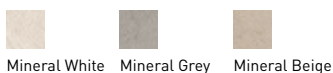

9838

10 pc/box 0,05 kg/pc

MINERAL CHROM* - Naturale



* Colori Mineral Black, Mineral Gold e Mineral Brown su richiesta Colours Mineral Black, Mineral Gold and Mineral Brown on request
 Coloris Mineral Black, Mineral Gold et Mineral Brown sur demande Farben Mineral Black, Mineral Gold und Mineral Brown Auf Anfrage

MINERAL CHROM

BORDO WIESBADEN A PAVIMENTO BORDER WIESBADEN HIGH-LEVEL TÊTE DE BASSIN WIESBADEN SURFLOT BECKENKOPF WIESBADEN HOCHLIEGEND

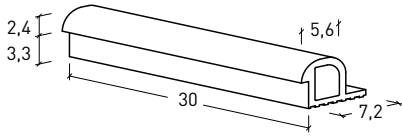

9860

Trim-Box 8 pc/box 0,96 kg/pc

MINERAL CHROM*

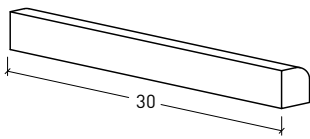
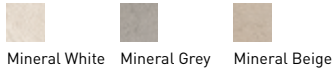

P 310-0296

Polyfill profilo / profile / profil / Profil*

* Vedi pagina: See page: Voir page: Siehe Seite: 36

SUPPORTO BETONBUILD CEMENTITIUS SUPPORT BETONBUILD SUPPORT EN BETON BETONBUILD TRÄGERELEMENT BETONBUILD

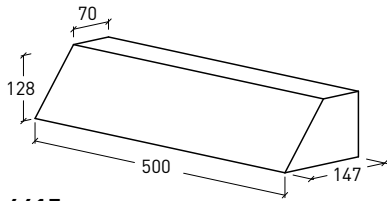

6415

Betonbuild 16,00 kg/pc 2 pc/ml

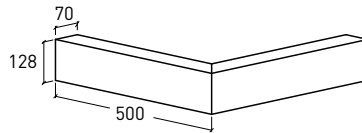

6417

Betonbuild 2 pc 45° 32,00 kg/pc

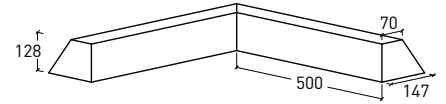

6418

Betonbuild 2 pc 45° 32,00 kg/pc

* Colori Mineral Black, Mineral Gold e Mineral Brown su richiesta Colours Mineral Black, Mineral Gold and Mineral Brown on request
Coloris Mineral Black, Mineral Gold et Mineral Brown sur demande Farben Mineral Black, Mineral Gold und Mineral Brown Auf Anfrage

BORDO WIESBADEN A PARETE BORDER WIESBADEN LOW-LEVEL TÊTE DE BASSIN WIESBADEN EN PAROI BECKENKOPF WIESBADEN TIEFLIEGEND

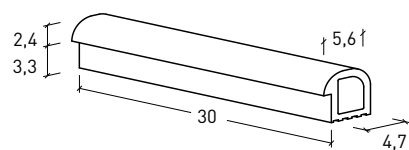
**9850**

Trim-Box 8 pc/box 0,8 kg/pc

MINERAL CHROM*

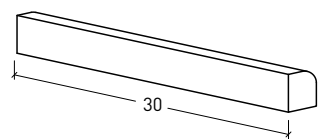

Mineral White Mineral Grey Mineral Beige

**P 310-0296**

Polyfill profilo / profile / profil / Profil*

* Vedi pagina: See page: Voir page: Siehe Seite: 36

SUPPORTO BETONBUILD CEMENTITIUS SUPPORT BETONBUILD SUPPORT EN BETON BETONBUILD TRÄGERELEMENT BETONBUILD

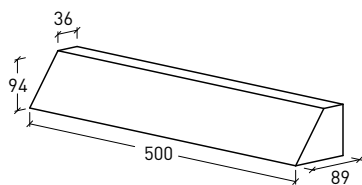
**6315**

Betonbuild 12,00 kg/pc 2 pc/ml

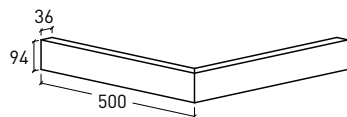
**6317**

Betonbuild 2 pc 45° 24,00 kg/pc

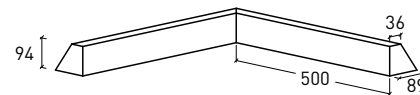
**6318**

Betonbuild 2 pc 45° 24,00 kg/pc

MINERAL CHROM

BORDO VASCA SKIMMER SKIMMER POOL BORDER TÊTE DE BASSIN SKIMMER BECKENKOPF SKIMMER

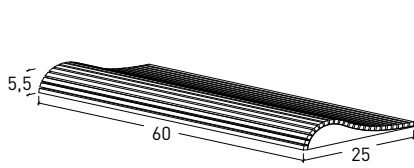

9660 - Pool Wave

1 pc/box 10,0 kg/pc

MINERAL CHROM* - Naturale

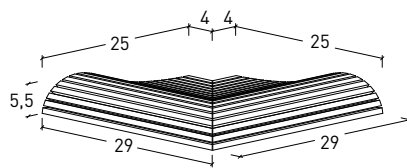
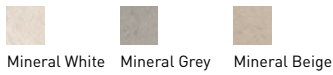

9667 - Pool Wave

2 pc 45° 1+1 pc/box 9,8 kg/pc

MINERAL CHROM* - Naturale

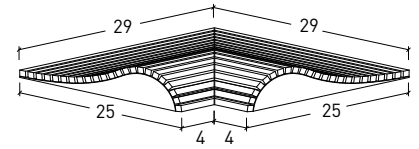
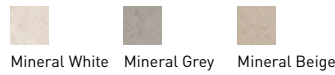

9668 - Pool Wave

2 pc 45° 1+1 pc/box 9,8 kg/pc

MINERAL CHROM* - Naturale

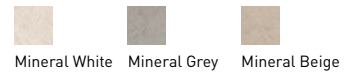

GRIGLIE IN CERAMICA PARALLELE PARALLEL CERAMIC GRATINGS GRILLES CÉRAMIQUES PARALLELES PARALLELE ROSTE AUS KERAMIK

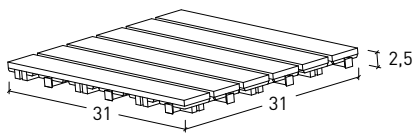

9842 ⁽¹⁾

6 pc/box 2,3 kg/pc

MINERAL CHROM* - Naturale

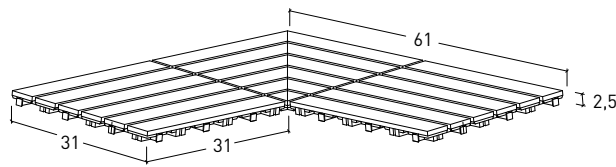
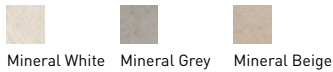

9843 ⁽¹⁾

2 pc 45° 2+2 pc/box 7,9 kg/pc

MINERAL CHROM* - Naturale

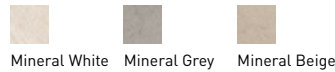

⁽¹⁾ Idoneità e geometria della griglia da verificare con i professionisti incaricati della progettazione della piscina e dei relativi impianti Adequacy and geometry of the grating to be approved by the specialists in charge of the designing of the pool and of the related equipment Adecuation et geometrie de la grille a bien verifier par les responsables de la conception de la piscine et des installations associees Eignung und Geometrie des Gitters sind mit den Fachleuten zu ueberpruefen, die fuer die Gestaltung des Pools und seiner Systeme verantwortlich sind

* Colori Mineral Black, Mineral Gold e Mineral Brown su richiesta Colours Mineral Black, Mineral Gold and Mineral Brown on request
Coloris Mineral Black, Mineral Gold et Mineral Brown sur demande Farben Mineral Black, Mineral Gold und Mineral Brown Auf Anfrage

SUPPORTI GRIGLIA GRATING SUPPORTS SUPPORT DE GRILLE ROSTAUFLAGER

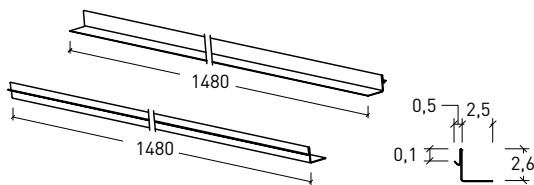

SL25 - IR16*

Supporto griglia in acciaio inox
Stainless steel grating support
Support de grille inox
Rostträger aus Edelstahl

* Articolo realizzato con acciaio inox AISI 316L-BA - EN 1.4404 (Lucido)
Item made with stainless steel AISI 316L-BA - EN 1.4404 (Polished)
Référence fabriquée en acier inox AISI 316L-BA - EN 1.4404 (Poli)
Artikel aus Edelstahl AISI 316L-BA - EN 1.4404 (Glanzend)

PIASTRELLE DI INDICAZIONE MARKING TILES CARREAUX NUMEROTES ANZEIGEFLEISEN

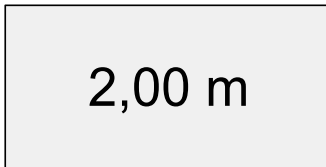
**D400**

Formato 30x60. Carattere Arial Narrow (altezza 7 cm - spessore 7mm)
 Size 30x60. Font Arian Narrow (height 7 cm - width 7 mm)
 Format 30x60. Caractère Arial Narrow (hauteur 7 cm - largeur 7 mm)
 Format 30x60. Schrifttyp Arial Narrow (Schriftöhe 7 cm - Schriftdicke 7 mm)

MINERAL CHROM - Naturale/Soft

Mineral White Mineral Grey Mineral Black



Mineral Beige Mineral Gold Mineral Brown

CANALETTA CERAMICA LINEARE CP007 ASSEMBLATA SU RETE LINEAR CERAMIC CHANNEL CP007 ASSEMBLED ON MESH
CANIVEAU CERAMIQUE LINEAIRE CP007 ASSEMBLE SUR TREILLIS LINEARKERAMISCHE RINNE CP007 AUF NETS GEKLEBT

Vedi pagina: See page: Voir page: Siehe Seite: **185**

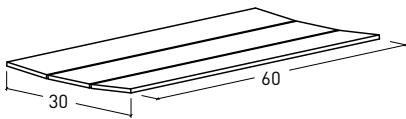
**9795***

Padana-Deck 6 pc/box 10,0 kg/pc

MINERAL CHROM - Naturale**

Mineral White Mineral Grey Mineral Beige

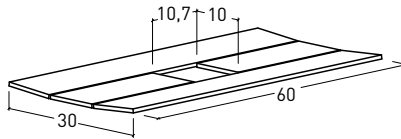
**9796***

Padana-Deck 6 pc/box 9,8 kg/pc

MINERAL CHROM - Naturale**

Mineral White Mineral Grey Mineral Beige

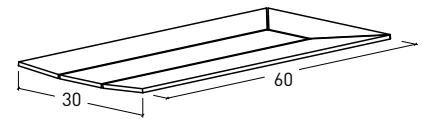
**9797***

Padana-Deck 6 pc/box 9,8 kg/pc

MINERAL CHROM - Naturale**

Mineral White Mineral Grey Mineral Beige

* Fornito assemblato su rete, da posizionarsi/inclinarsi in opera. Assemblaggio ad inclinazione flessibile fino a max 10% Supplied on mesh to be positioned/adapted on site.
 Assembly with flexible slope up to max 10% Fourni assemble sur trame, a positionner/incliner sur chantier. Assemblage flexible avec pentes jusqu'à 10% Wird auf Netz
 montiert geliefert, auf der Baustelle zu positionieren neigen. Flexibel Montage mit Neigungen bis max 10%

** Colori Mineral Black, Mineral Gold e Mineral Brown su richiesta Colours Mineral Black, Mineral Gold and Mineral Brown on request
 Coloris Mineral Black, Mineral Gold et Mineral Brown sur demande Farben Mineral Black, Mineral Gold und Mineral Brown Auf Anfrage

Sistema finlandese

FINNISH SYSTEM
 SYSTEME FINLANDAIS
 SYSTEM FINNLAND

BORDI FINLANDESE SENZA AGGRAPPO FINNISH POOL BORDERS WITHOUT FINGER GRIP **TÊTES FINLANDAISES SANS ACCROCHE DOIGTS**
 BECKENKÖPFEN FINNLAND OHNE HANDFASS

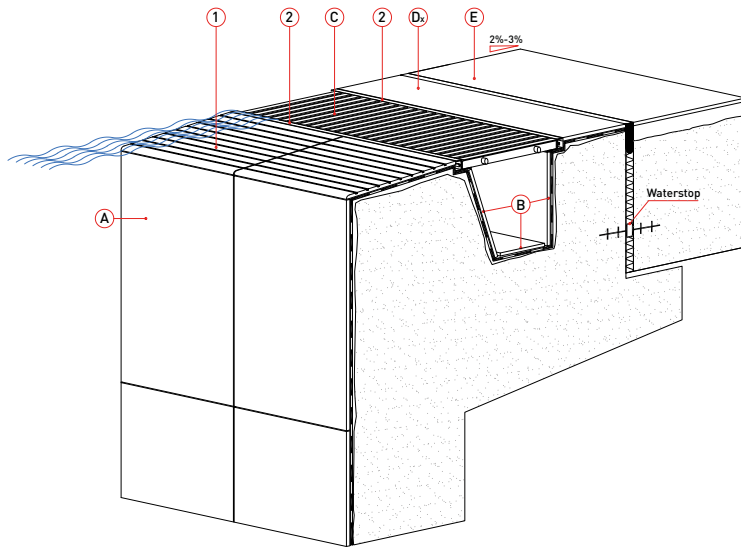

mod. FMIN 002

- A** MINERAL CHROM - Soft_interno vasca / pool tank / interieur bassin / becken
- B** MINERAL CHROM - Soft_canaletta di ricircolo / overflow channel / caniveau eau bassin / rinne
- C** PADANA GRID_griglia in pvc / grating in pvc / grille en pvc / pvc rost
- D** MINERAL CHROM - Naturale_pezzo di connessione spiaggia / pool deck connection piece / piece de connexion plage / verbindungsstück
- E** MINERAL CHROM - Naturale_esterno vasca / pool surround / plage / beckenumgang

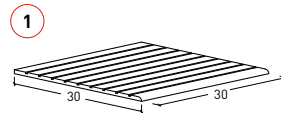

9876
MINERAL CHROM - Naturale
 Mineral White Mineral Grey Mineral Beige

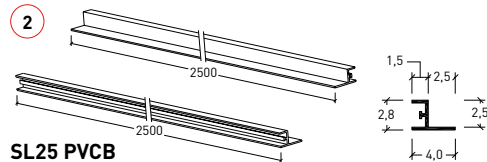

SL25 PVCB
 Padana-Grid
 Supporto griglia in pvc / Pvc grating support /
 Corniere in pvc / Pvc rost traeger

x = Dimensione variabile dell'articolo, da tagliare in cantiere
 Item with variable dimensions, to be cut on site
 Dimensions de l'article variables, à couper sur le chantier
 Variable Größe des Artikels, vor Ort zu schneiden

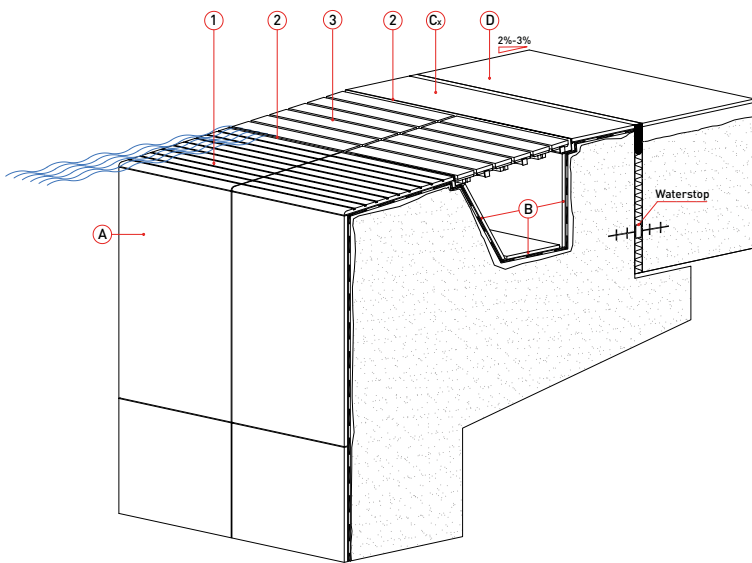

mod. FMIN 005.1

- A** MINERAL CHROM - Soft_interno vasca / pool tank / interieur bassin / becken
- B** MINERAL CHROM - Soft_canaletta di ricircolo / overflow channel / caniveau eau bassin / rinne
- C** MINERAL CHROM - Naturale_pezzo di connessione spiaggia / pool deck connection piece / piece de connexion plage / verbindungsstück
- D** MINERAL CHROM - Naturale_esterno vasca / pool surround / plage / beckenumgang

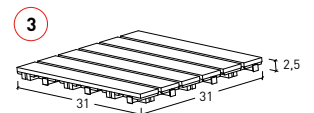
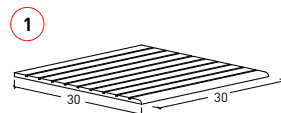

9876
MINERAL CHROM
 Mineral White Mineral Grey Mineral Beige

9842

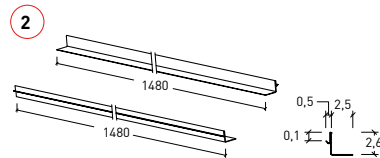

SL25 - IR16
 Supporto griglia in acciaio inox / Stainless steel grating support /
 Support de grille inox / Rostträger aus Edelstahl

x = Dimensione variabile dell'articolo, da tagliare in cantiere
 Item with variable dimensions, to be cut on site
 Dimensions de l'article variables, à couper sur le chantier
 Variable Größe des Artikels, vor Ort zu schneiden



Sistema Wiesbaden

WIESBADEN SYSTEM
SYSTEME WIESBADEN
SYSTEM WIESBADEN

BORDI WIESBADEN A PAVIMENTO WIESBADEN POOL BORDERS HIGH-LEVEL TÊTES WIESBADEN SURFLOT BECKENKÖPFEN WIESBADEN HOCHLIEGEND

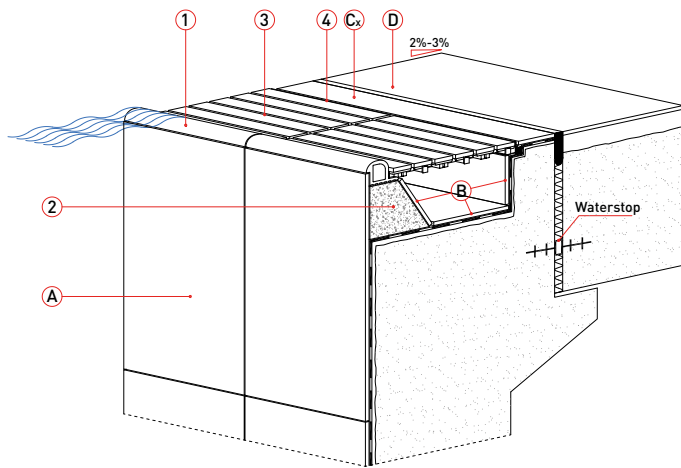

mod. WMIN 001.2

- A** MINERAL CHROM - Soft_interno vasca / pool tank / interieur bassin / becken
- B** MINERAL CHROM - Soft_canaletta di ricircolo / overflow channel / caniveau eau bassin / rinne
- C** MINERAL CHROM - Naturale_pezzo di connessione spiaggia / pool deck connection piece / piece de connexion plage / verbindungsstück
- D** MINERAL CHROM - Naturale_esterno vasca / pool surround / plage / beckenumgang

x= Dimensione variabile dell'articolo, da tagliare in cantiere
Item with variable dimensions, to be cut on site
Dimensions de l'article variables, à couper sur le chantier
Variable Größe des Artikels, vor Ort zu schneiden

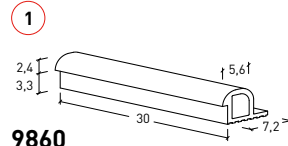

9860
Trim-Box

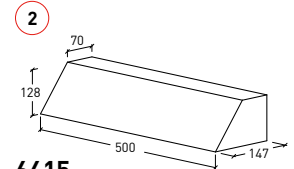

6415
Betonbuild

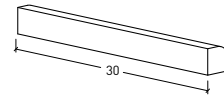

P 310-0296
Polyfill profilo / profile / profil / Profil*

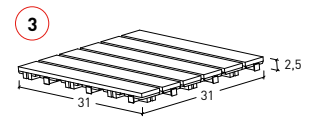

9842

* Vedi pagina: See page: Voir page: Siehe Seite: 36

MINERAL CHROM

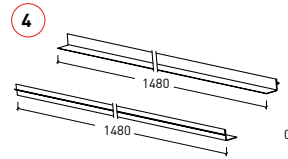

SL25 - IR16

Supporto griglia in acciaio inox / Stainless steel grating support / Support de grille inox / Rosträger aus Edelstahl

BORDO WIESBADEN A PARETE WIESBADEN POOL BORDER LOW-LEVEL TÊTE WIESBADEN EN PAROI BECKENKÖPFEN WIESBADEN TIEFLIEGEND

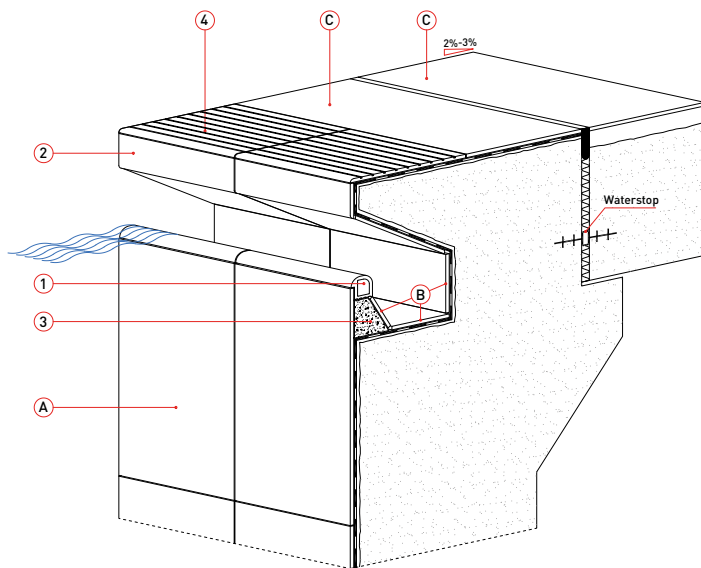

mod. WMIN 005.1

- A** MINERAL CHROM - Soft_interno vasca / pool tank / interieur bassin / becken
- B** MINERAL CHROM - Soft_canaletta di ricircolo / overflow channel / caniveau eau bassin / rinne
- C** MINERAL CHROM - Naturale_esterno vasca / pool surround / plage / beckenumgang

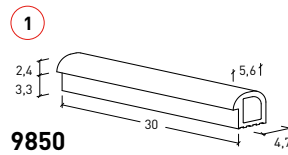

9850
Trim-Box

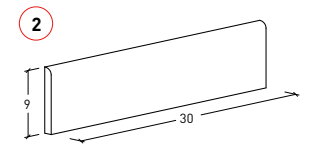

BATTISCOPA B.C. 9x30

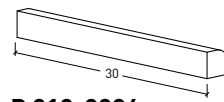

P 310-0296
Polyfill profilo / profile / profil / Profil*

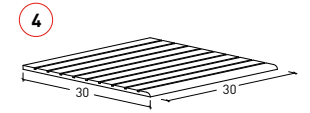

9876

* Vedi pagina: See page: Voir page: Siehe Seite: 36

MINERAL CHROM

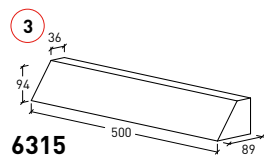

6315
Betonbuild



Sistema a Skimmer

SKIMMER SYSTEM
SYSTEME SKIMMER
SYSTEM SKIMMER

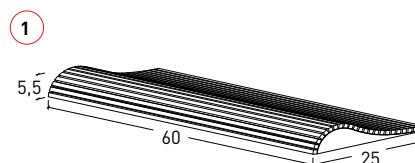
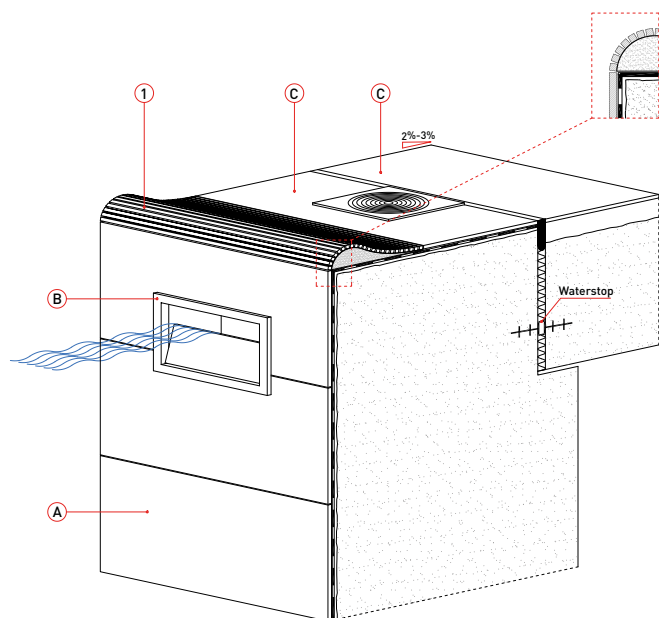

9660 - Pool Wave

MINERAL CHROM - Naturale



mod. SKMIN 9660

- A MINERAL CHROM - Soft_interno vasca / pool tank / interieur bassin / becken
- B Skimmer
- C MINERAL CHROM - Naturale_esterno vasca / pool surround / plage / beckenumgang

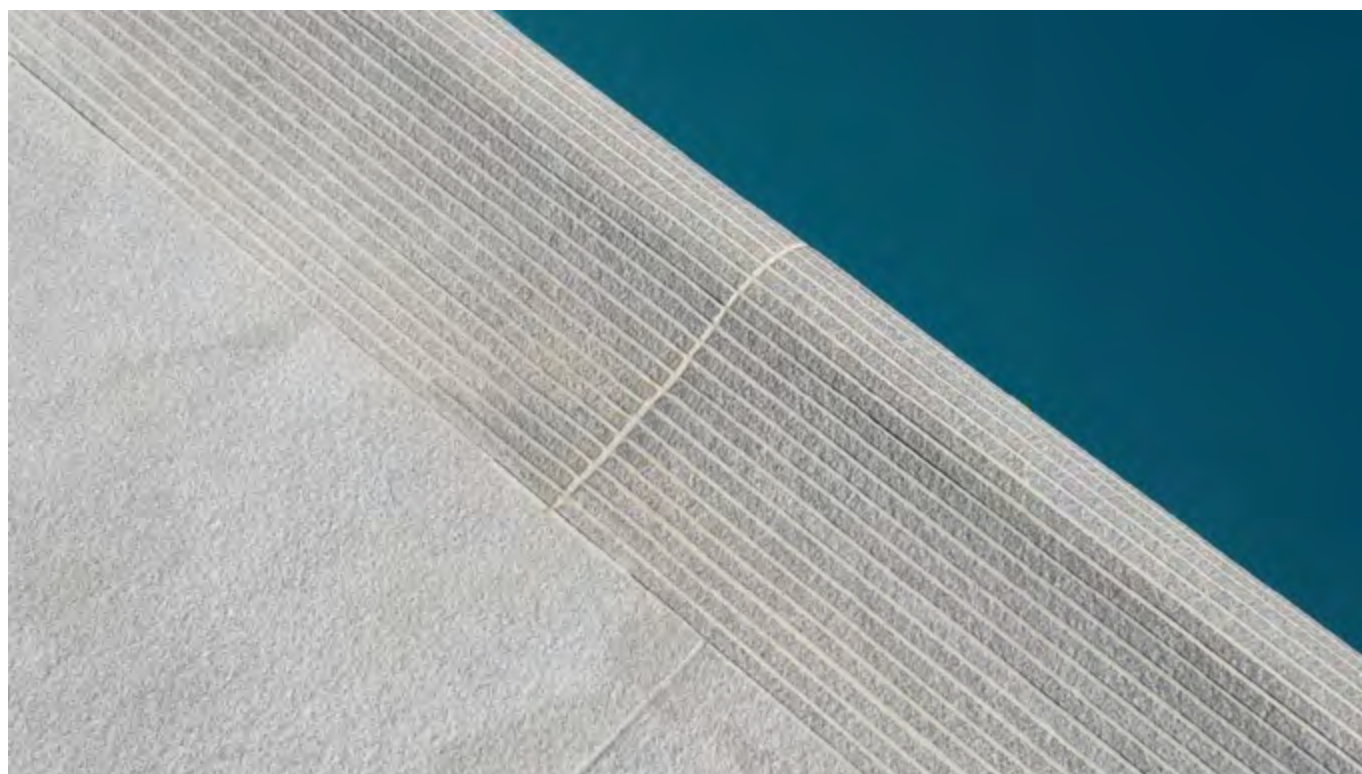

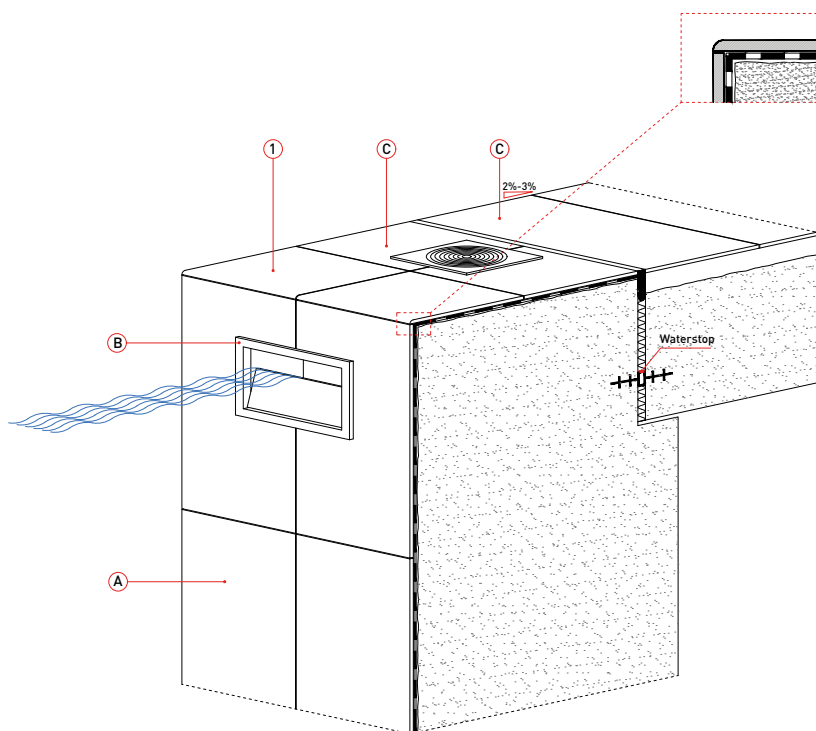

1



Gradino B.C. 30x30 senza righe

12 pc/box 1,8 kg/pc

MINERAL CHROM - Naturale



Mineral White



Mineral Grey



Mineral Black



Mineral Beige



Mineral Gold



Mineral Brown

mod. SKMIN GRADINO B.C. 30x30

A interno vasca / pool tank / interieur bassin / becken

B Skimmer

C esterno vasca / pool surround / plage / beckenumgang

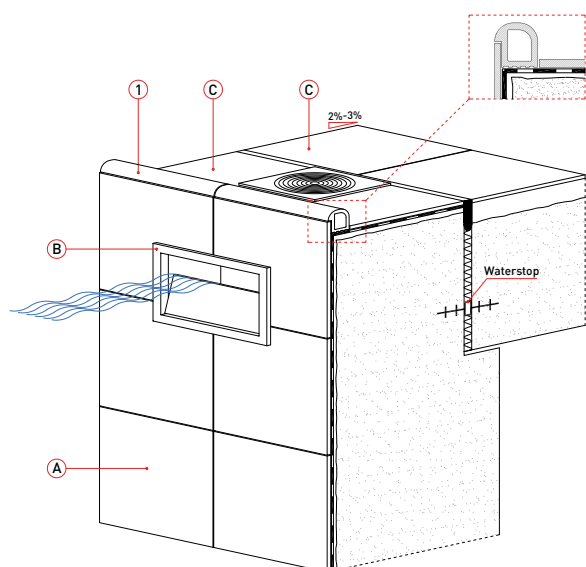

1

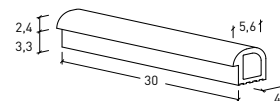

9850

Trim-Box

MINERAL CHROM



Mineral White



Mineral Grey



Mineral Beige

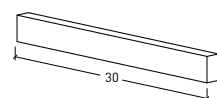

P 310-0296

Polyfill profilo / profile / profil / Profil*

* Vedi pagina: See page: Voir page: Siehe Seite: 36

mod. SKMIN 9850

A MINERAL CHROM - Soft_interno vasca / pool tank / interieur bassin / becken

B Skimmer

C MINERAL CHROM - Naturale_esterno vasca / pool surround / plage / beckenumgang

Scale e gradini immersi in acqua

IMMERGED STAIRS AND STEPS
ESCALIERS ET MARCHES IMMERGÉES DANS L'EAU
TREPPEN UND STUFEN INS WASSER

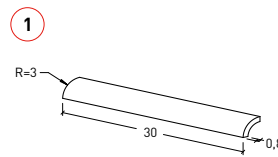
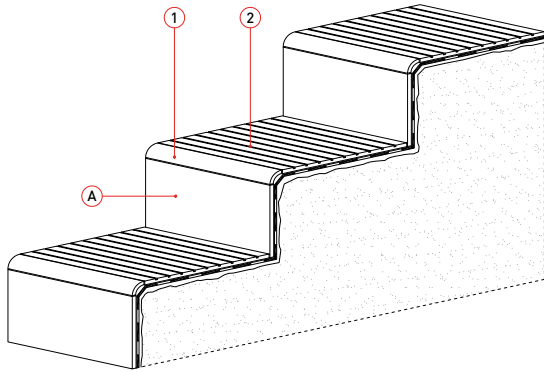

9835

MINERAL CHROM



Mineral White



Mineral Grey



Mineral Beige

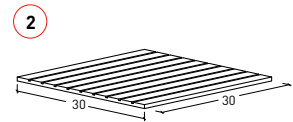

9870

MINERAL CHROM - Naturale



Mineral White



Mineral Grey



Mineral Beige

mod. SCMIN 01

A MINERAL CHROM - Soft
alzata / tread riser / contremarche / setzstufe



scale e gradini immersi in acqua / immersed stairs and steps / escaliers et marches immergées dans l'eau /
treppen und stufen ins wasser

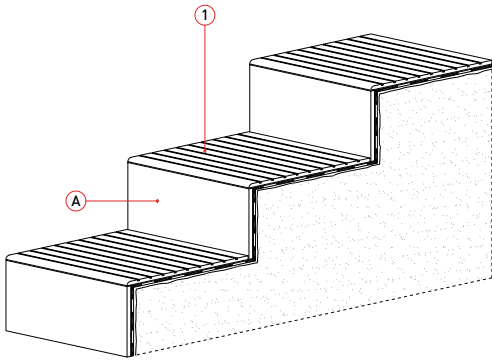

mod. SCMIN 03

A MINERAL CHROM - Soft
alzata / tread riser / contremarche / setzstufe

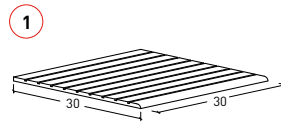

9876

MINERAL CHROM - Naturale

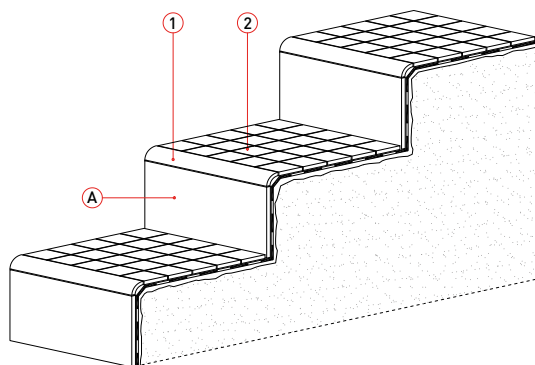

mod. SCMIN 04

A MINERAL CHROM - Soft
alzata / tread riser / contremarche / setzstufe

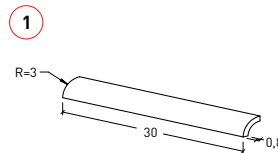

9835

MINERAL CHROM - Naturale

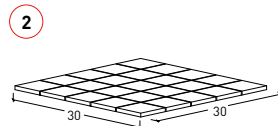
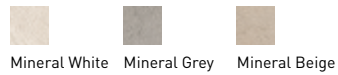

MOSAICO 6x6

MINERAL CHROM - Naturale



Muretti di testata e muretti

HEADWALLS AND FENCES
 QUAIS DE DÉPART ET MURETS
 STIRNWÄNDE UND MAUERN

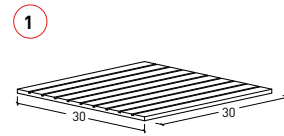
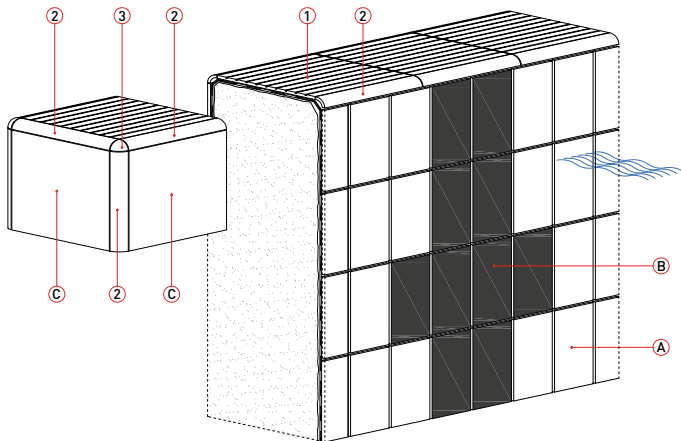

9870

MINERAL CHROM - Naturale



Mineral White Mineral Grey Mineral Beige

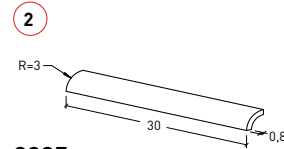

9835

MINERAL CHROM - Naturale



Mineral White Mineral Grey Mineral Beige

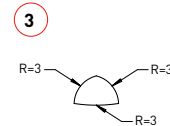

9837

MINERAL CHROM - Naturale



Mineral White Mineral Grey Mineral Beige

mod. QDMIN 02

- A** LANDSCAPE - Friction_fascia di virata / turning area / zone de virage / wandflaeche
- B** LANDSCAPE - Friction_vie di corsa / marking lanes / ligne de nage / bahnamarkierungen
- C** MINERAL CHROM - Soft_rivestimento esterno / external wall / revetement exterieur / wandbekleidung



muretti di testata e muretti / headwalls and fences / quais de départ et murets / stirnwände und Mauern

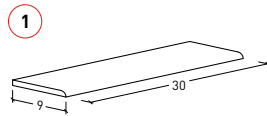
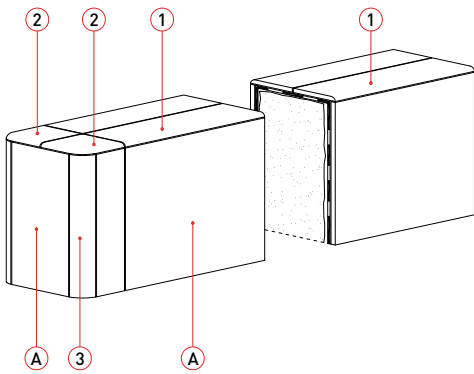

1
Terminale Gradino B.C. 9x30

MINERAL CHROM - Naturale

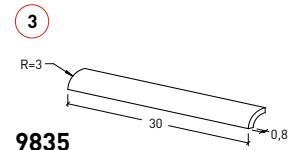
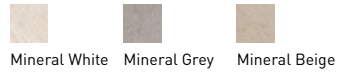

3
9835

MINERAL CHROM - Naturale

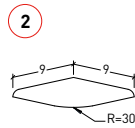
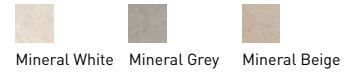

2
9900 Angolo Terminale Gradino B.C. 9x9

MINERAL CHROM - Naturale

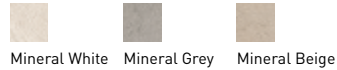

mod. MUMIN 01

A MINERAL CHROM - Soft
rivestimento / wall tiling / revetement / wandfliesen

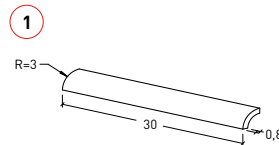
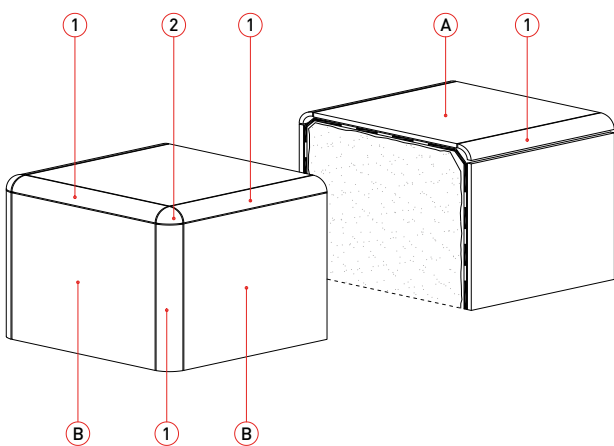

1
9835

MINERAL CHROM - Naturale

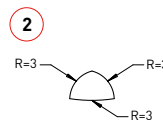

2
9837

MINERAL CHROM - Naturale



mod. MUMIN 02

A MINERAL CHROM - Naturale_rivestimento / wall tiling / revetement / wandfliesen
B MINERAL CHROM - Soft_rivestimento / wall tiling / revetement / wandfliesen

Angoli e spigoli arrotondati

ROUNDED IN-CORNERS AND OUT-CORNERS
 ANGLES SORTANTS ET RENTRANTS ARRONDIS
 GERUNDETE KANTEN UND ECKEN

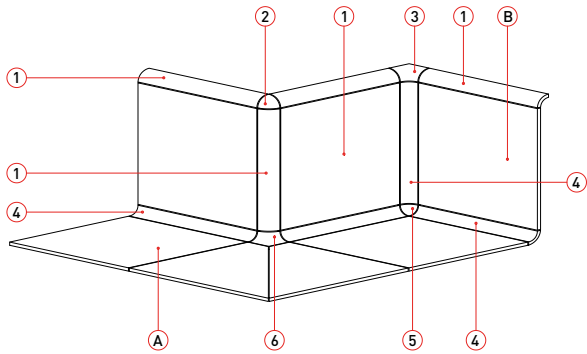

mod. FIMIN 01

- A** MINERAL CHROM - Naturale_pavimento / floor / carrelage de sol / bodenfliesen
- B** MINERAL CHROM - Soft_rivestimento / wall tiling / revetement / wandfliesen

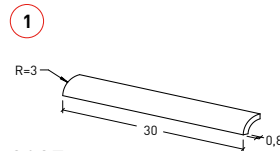

9835
 MINERAL CHROM - Naturale
 Mineral White Mineral Grey Mineral Beige

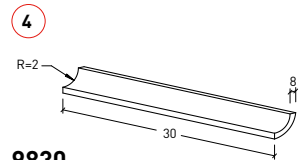

9830
 MINERAL CHROM - Naturale
 Mineral White Mineral Grey Mineral Beige

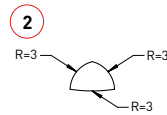

9837
 MINERAL CHROM - Naturale
 Mineral White Mineral Grey Mineral Beige

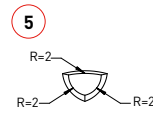

9833
 MINERAL CHROM - Naturale
 Mineral White Mineral Grey Mineral Beige

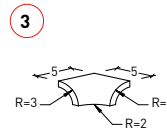

9838
 MINERAL CHROM - Naturale
 Mineral White Mineral Grey Mineral Beige

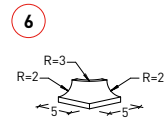

9834
 MINERAL CHROM - Naturale
 Mineral White Mineral Grey Mineral Beige

angoli e spigoli arrotondati / rounded in-corners and out-corners / angles sortants et rentrants arrondis / gerundete kanten und ecken

vasche lavapiedi / feet washers / pédiluves / durchschreitbecken

Vasche lavapiedi

FEET WASHERS
PÉDILUVES
DURCHSCHREITBECKEN

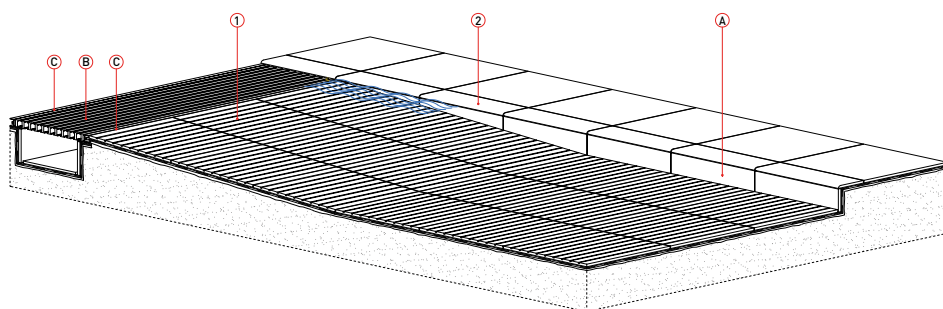

mod. PEMIN 01

- A MINERAL CHROM - Soft_rivestimento / wall tiling / revêtement / wandfliesen
- B PADANA GRID_griglia in pvc / grating in pvc / grille en pvc / pvc rost
- C PADANA GRID_angolare in pvc / pvc grating support / corniere en pvc / pvc rost traeger

1

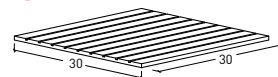

9870

MINERAL CHROM - Naturale

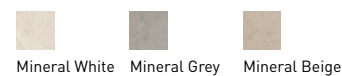

Mineral White Mineral Grey Mineral Beige

2

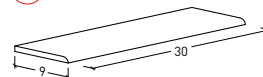

Terminale Gradino B.C. 9x30

MINERAL CHROM - Naturale



Mineral White Mineral Grey Mineral Beige



Amazzonia

PIETRE NATIVE

La serie Amazzonia, in gres fine porcellanato ha una superficie caratterizzata dalla leggera ruvidezza che si ispira alle pietre naturali più rare preziose, riproducendone fedelmente superfici, venature e cromatismi. È disponibile in cinque formati ed in otto colori dalla stonalizzazione accentuata che valorizza la matericità del prodotto.

Tutti i colori e formati della collezione Amazzonia sono disponibili con superficie Naturale con classe antiscivolo R10-A e superficie Grip con classe antiscivolo R11-C. Nel solo formato 30x60 cm (rettificato), i colori Dragon White, Dragon Grey e Dragon Beige sono anche disponibili con la superficie Semi-Grip che offre una classe antiscivolo R11-B. Completano la serie mosaici, decori e pezzi speciali per il rivestimento di piscine, spa ed esterni vasche indoor ed outdoor.

The porcelain tiles of the Amazzonia range take inspiration from the rarest and most precious natural stones and faithfully reproduce their textures, shades, veins and colours. It is available in five sizes and eight colours with impressive stone effects that make the most of the product's texture. Mosaics, decorations and fittings complete the products range and offer different technical and aesthetical solutions for public and private swimming pools, both indoors and outdoors.

All colours and sizes of the collection Amazzonia are manufactured with both surface Naturale (R10-A) and surface Grip (R11-C). For the size 30x60 cm (rectified) only, the colours Dragon White, Dragon Grey and Dragon Beige can be produced also with surface Semi-Grip offering a non-slip rate R11-B. Provide the possibility to properly tile dry and wet areas as well as wall claddings.

La série Amazzonia, carreaux et dalles en grès cérame, s'inspire des pierres naturelles les plus rares et les plus précieuses, en reproduisant fidèlement leurs surfaces, veines et chromatismes. Disponible en cinq formats et huit couleurs avec des estompages éclatants qui montent en exergue la matérialité du produit, elle est complétée par des mosaïques, décorations et pièces spéciales permettant de réaliser les finitions typiques des piscines publiques, d'hotels et particulières d'intérieur et d'extérieur.

Toutes les couleurs et les formats de la collection Amazzonia sont fabriqués avec finition Naturelle (R10-A) et avec finition Grip (R11-C). Uniquement dans le format 30x60 (rectifié) les couleurs Dragon White, Dragon Grey et Dragon Beige sont fabriqués aussi avec la finition Semi-Grip classée R11-B. Permettent de créer une continuité esthétique entre les zones sèches et les zones mouillées, ainsi qu'entre les planchers et les revêtements.

Zur Serie Amazzonia gehören Platten aus Feinsteinzeug, die sich an den seltensten und kostbarsten Natursteinen inspirieren und ihre Texturen, Äderungen und Farben getreu nachgestalten. Verfügbar in fünf Formaten und acht Farben mit ausgeprägten Tonabweichungen, die das Material des Produktes aufwerten. Dazu gehören Mosaik, Dekore und Formstücke, mit denen die typischen Veredelungen der öffentlichen und privaten Schwimmbäder Indoor- und Outdoor gestaltet werden können.

Alle Farben und Größen der Serie Amazzonia sind in der Oberfläche Natur mit Rutschfestigkeit R10-A erhältlich und in der Oberfläche Grip mit Rutsch-Klasse R11-C. Nur im Format 30x60 cm (rektifiziert) sind auch die Farben Dragon White, Dragon Grey und Dragon Beige mit der Semi-Grip-Oberfläche erhältlich, die eine R11-B-Rutschfestigkeitsklasse bietet. Lassen sich ästhetisch kontinuierliche Übergänge von Trockenauf Nassbereiche und von Boden- auf Wandflächen gestalten.





naturale



grip

Formati Sizes Formats Formate	cm 30x30 11 ³ / ₄ "x11 ³ / ₄ "	cm 45x45 17 ³ / ₄ "x17 ³ / ₄ "	cm 30,5x61 12"x24"	cm 30x60 11 ³ / ₄ "x23 ⁵ / ₈ "	cm 60x60 23 ⁵ / ₈ "x23 ⁵ / ₈ "	cm 45x90 17 ³ / ₄ "x35 ³ / ₈ "	cm 45x90 17 ³ / ₄ "x35 ³ / ₈ "
Spessori Thicknesses Épaisseurs Stärken	mm 9	mm 10	mm 9*	mm 10 mm 9	mm 10	mm 10	mm 20**
Superfici Surfaces Surfaces Oberflächen	● ●	● ●	● ●	● ● ● ●***	● ●	● ●	●

● Naturale ^[1]

DIN 51097 A	XP P 05-010 PN 12	
DIN 51130 R 10	XP P 05-010 PC 10	

● Grip ^[2]

DIN 51097 C	XP P 05-010 PN 24	
DIN 51130 R 11	XP P 05-010 PC 20	

● Semi-Grip*** ^[2]

DIN 51097 B	XP P 05-010 PN 18	
DIN 51130 R 11	XP P 05-010 PC 20	

Rettificata in un unico calibro Rectified version in a single caliber Rectifiés en un unique calibre Boden Sie in einem einzigen Kaliber

* Non rettificato Unrectified Non rectifié Nicht kalibriert

** Solo nei colori: Only in the colours: Seulement dans les couleurs: Nur in die Farben: Dragon Black, Dragon Grey, Dragon Beige, Dragon White, Dragon Brown

*** Solo nei colori (spessore 9 mm): Only in the colours (thickness 9 mm): Seulement dans les couleurs (épaisseur 9 mm): Nur in die Farben (Stärke 9 mm): Dragon Grey, Dragon Beige, Dragon White

^[1] A pavimento: zone asciutte Floor: dry zones Revêtement de sol : zones sèches Boden: trokenzonen

^[2] A pavimento: zone asciutte e zone umide Floor: dry zones and wet zones Revêtement de sol : zones sèches et zones humides Boden: trokenzonen und feuchtzonen

AMAZZONIA

Dragon Black

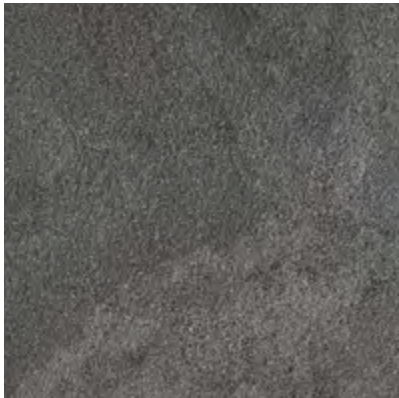

Dragon Green



Dragon Grey



Dragon White



Dragon Brown



Dragon Beige

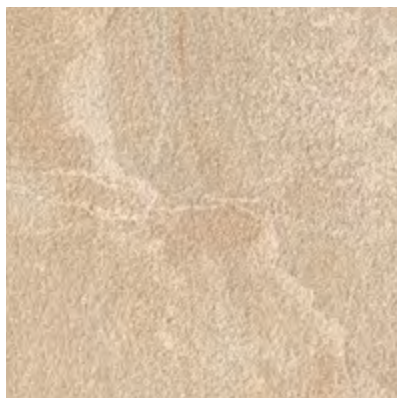

Eldorado



Accentuata
Accentuated
Importante
Starke

Vedi pagina: See page: Voir page: Siehe Seite: **209**

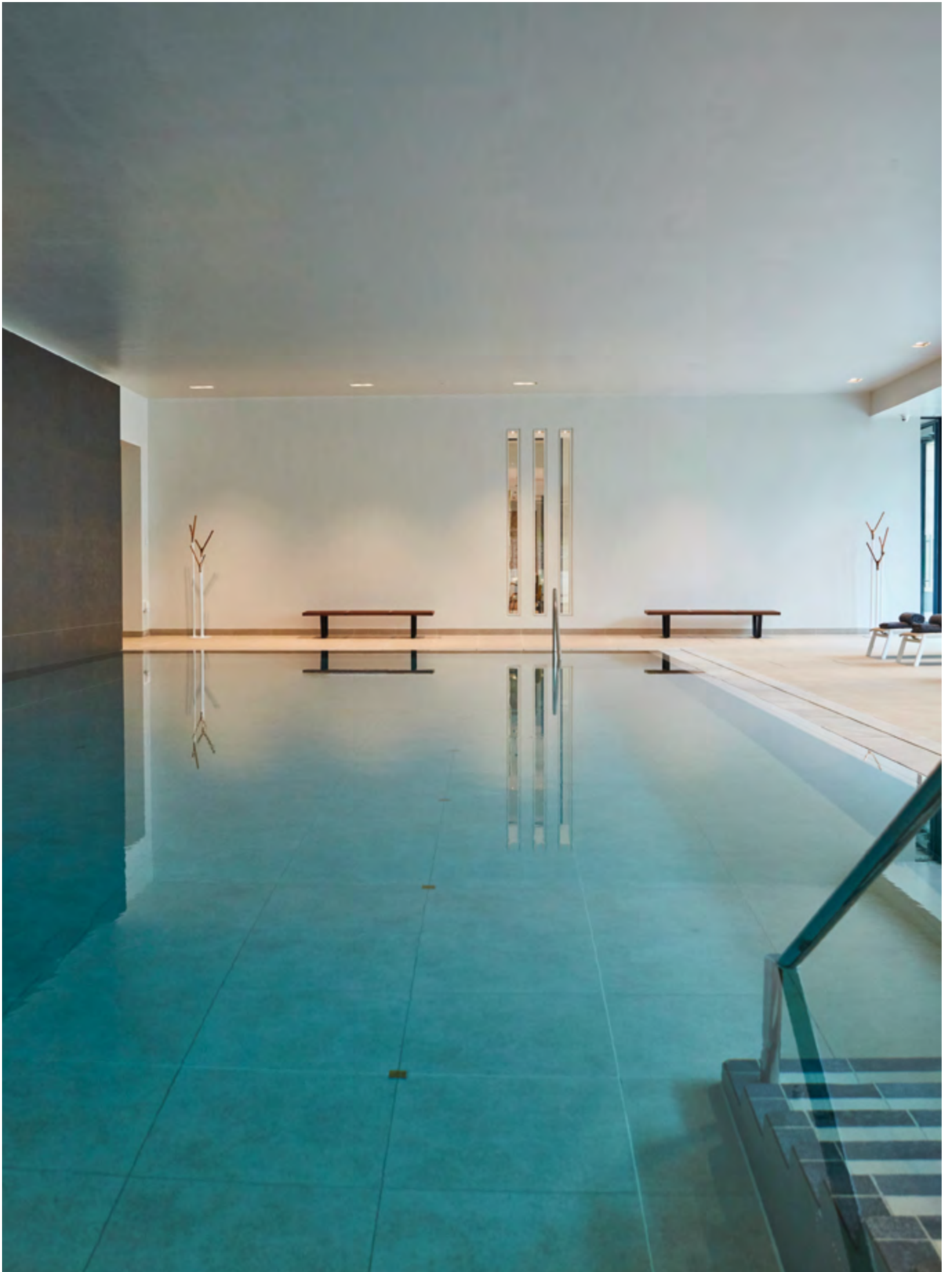

AMAZZONIA

MOSAICI*

Mosaico Amazonia 3x3

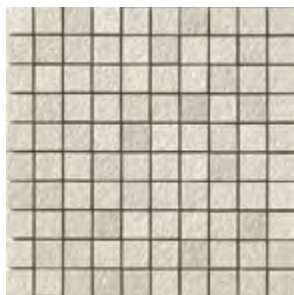

30x30 cm 11^{3/4}"x11^{3/4}"
3x3 cm 1^{1/8}"x1^{1/8}"

Standard su rete
Standard on net
Standard sur trame
Standard auf Netz

Su richiesta con rete davanti
On demand with net on front side
Sur demande avec trame sulla belle face
Auf Anfrage mit Netz auf Vorderseite

Mosaico Amazonia 6x6



30x30 cm 11^{3/4}"x11^{3/4}"
6x6 cm 2^{3/8}"x2^{3/8}"

Standard su rete
Standard on net
Standard sur trame
Standard auf Netz

Su richiesta con rete davanti
On demand with net on front side
Sur demande avec trame sulla belle face
Auf Anfrage mit Netz auf Vorderseite

Vedi dettagli a pagina: See details on page: Voir détails à la page: Siehe Details auf Seite: 210

DECORI*

Composizione A

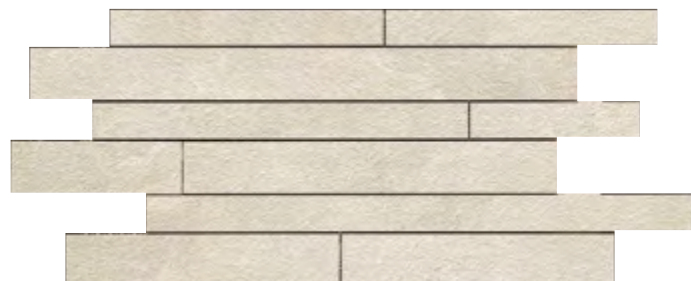

30x60 cm 11^{3/4}"x23^{5/8}"
su rete / on net / sur trame / auf Netz

GRIGLIE CERAMICHE**

Art. 9842



* Disponibile in tutti i colori della serie su superficie Naturale. A richiesta su superficie Grip Available in all the colours with surface Naturale. On request also on Grip surface Disponible dans toutes les couleurs pour la surface Naturale. Sur demande la finition Grip Verfügbar in allen Farben der Serie mit Oberfläche Naturale. Auf Anfrage Grip Oberfläche

** Disponibili in tutti i colori con superficie Grip Available in all the colours with surface Grip Disponibles dans toutes les couleurs avec finition Grip Verfügbar in allen Farben mit Oberfläche Grip

PIASTRELLE NUMERATE*

Art. D400

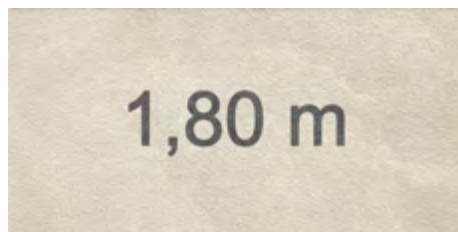



GRADINI E TERMINALI GRADINO STEP TREADS MARCHES ET NEZ DE MARCHÉ STUFEN UND TREPPENPLATTEN

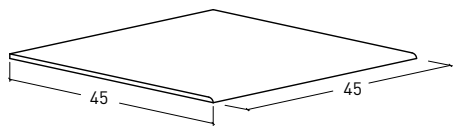

Gradino B.C. Grip 45x45 senza righe
5 pc/box 5,0 kg/pc

AMAZZONIA - Naturale/Grip

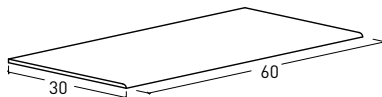

Gradino B.C. Grip 30x60 senza righe
6 pc/box 3,89 kg/pc

AMAZZONIA - Naturale/Grip

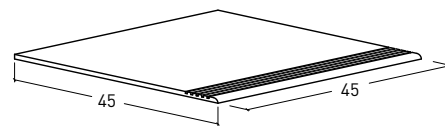

Gradino B.C. 45x45 con righe
5 pc/box 5,0 kg/pc

AMAZZONIA - Naturale

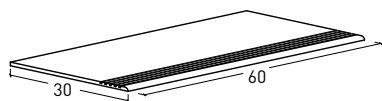

Gradino B.C. 30x60 con righe
6 pc/box 3,89 kg/pc

AMAZZONIA - Naturale

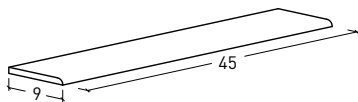

Bordo / Terminale Gradino B.C. 9x45
18 pc/box 0,75 kg/pc

AMAZZONIA - Grip*

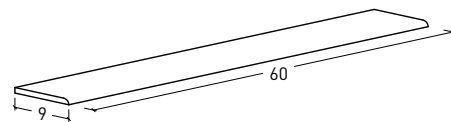

Bordo / Terminale Gradino B.C. 9x60
18 pc/box 1,0 kg/pc

AMAZZONIA - Grip*

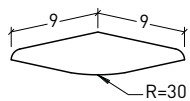

9900 Angolo Bordo / Terminale Gradino B.C. 9x9
10 pc/box 0,2 kg/pc

AMAZZONIA - Naturale/Grip*



* Colori Dragon Green, Dragon Brown, Eldorado su richiesta Colours Dragon Green, Dragon Brown, Eldorado on request Coloris Dragon Green, Dragon Brown, Eldorado sur demande Farben Dragon Green, Dragon Brown, Eldorado Auf Anfrage

BATTISCOPA SKIRTING BORD ARRONDI SOCKEL

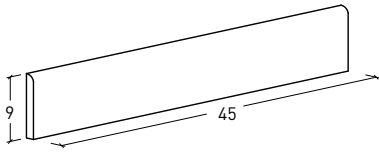

Battiscopa B.C. 9x45
18 pc/box 0,75 kg/pc

AMAZZONIA - Naturale

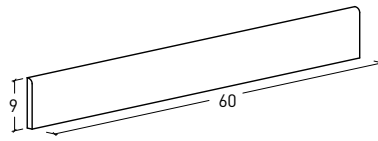

Battiscopa B.C. 9x60
18 pc/box 1,0 kg/pc

AMAZZONIA - Naturale



SGUSCIE E COPRI SPIGOLI COVES AND QUARTER ROUNDS GORGES ET QUARTS DE ROND HOHLKEHLEN UND RADIALLEISTEN

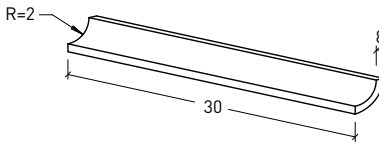

9830
48 pc/box 0,2 kg/pc

AMAZZONIA*

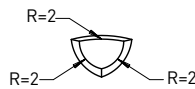

9833
10 pc/box 0,05 kg/pc

AMAZZONIA*

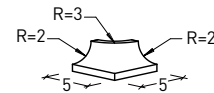
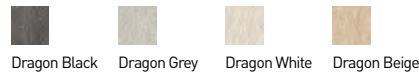

9834
10 pc/box 0,05 kg/pc

AMAZZONIA*

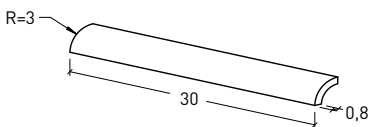
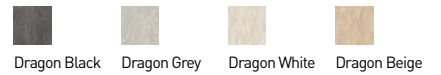

9835
48 pc/box 0,2 kg/pc

AMAZZONIA - Grip*

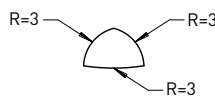

9837
10 pc/box 0,05 kg/pc

AMAZZONIA - Grip*

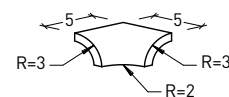

9838
10 pc/box 0,05 kg/pc

AMAZZONIA*



* Colori Dragon Green, Dragon Brown, Eldorado su richiesta Colours Dragon Green, Dragon Brown, Eldorado on request Coloris Dragon Green, Dragon Brown, Eldorado sur demande Farben Dragon Green, Dragon Brown, Eldorado Auf Anfrage

AMAZZONIA

BORDO VASCA FINLANDESE FINNISH POOL BORDER TÊTE DE BASSIN FINLANDAISE BECKENKOPF FINNLAND

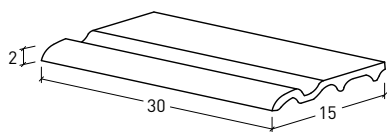

9846

10 pc/box 1,7 kg/pc

AMAZZONIA - Grip*

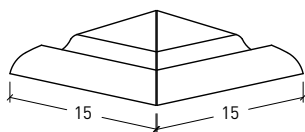

9847

10 pc/box 0,8 kg/pc

AMAZZONIA - Grip*

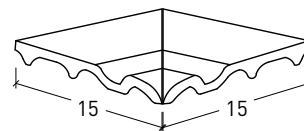

9848

10 pc/box 0,8 kg/pc

AMAZZONIA - Grip*



BORDO VASCA WIESBADEN A PAVIMENTO POOL BORDER WIESBADEN HIGH-LEVEL TÊTE DE BASSIN WIESBADEN SURFLOT BECKENKOPF WIESBADEN HOCHLIEGEND

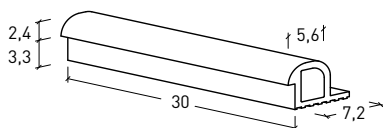

9860

Trim-Box 8 pc/box 0,96 kg/pc

AMAZZONIA*

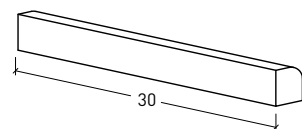

P 310-0296

Polyfill profilo / profile / profil / Profil*

* Vedi pagina: See page: Voir page: Siehe Seite: 36

SUPPORTO BETONBUILD CEMENTITIUS SUPPORT BETONBUILD SUPPORT EN BETON BETONBUILD TRÄGERELEMENT BETONBUILD

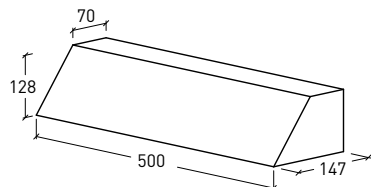

6415

Betonbuild 16,00 kg/pc 2 pc/mt



6417

Betonbuild 2 pc 45° 32,00 kg/pc

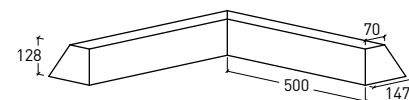

6418

Betonbuild 2 pc 45° 32,00 kg/pc

* Colori Dragon Green, Dragon Brown, Eldorado su richiesta Colours Dragon Green, Dragon Brown, Eldorado on request Coloris Dragon Green, Dragon Brown, Eldorado sur demande Farben Dragon Green, Dragon Brown, Eldorado Auf Anfrage

BORDO VASCA WIESBADEN A PARETE POOL BORDER WIESBADEN LOW-LEVEL TÊTE DE BASSIN WIESBADEN EN PAROI
BECKENKOPF ZÜRICH UND WIESBADEN TIEFLIEGEND

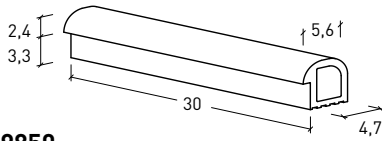

9850

Trim-Box 8 pc/box 0,8 kg/pc

AMAZZONIA*

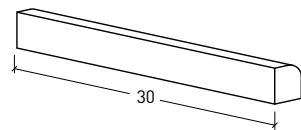

P 310-0296

Polyfill profilo / profile / profil / Profil*

* Vedi pagina: See page: Voir page: Siehe Seite: 36

SUPPORTO BETONBUILD CEMENTITIUS SUPPORT BETONBUILD SUPPORT EN BETON BETONBUILD TRÄGERELEMENT BETONBUILD

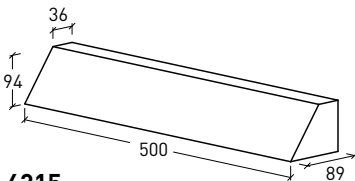

6315

Betonbuild 12,00 kg/pc 2 pc/ml

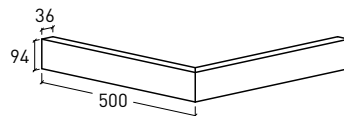

6317

Betonbuild 2 pc 45° 24,00 kg/pc

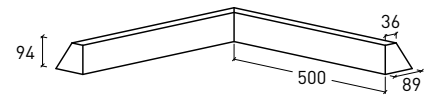

6318

Betonbuild 2 pc 45° 24,00 kg/pc

BORDO VASCA SKIMMER SKIMMER POOL BORDER TÊTE DE BASSIN SKIMMER BECKENKOPF SKIMMER

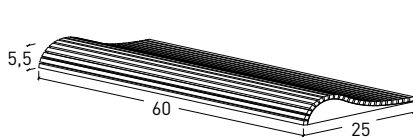

9660 - Pool Wave

1 pc/box 10,0 kg/pc

AMAZZONIA - Grip*



9560

2 pc/box 13,7 kg/pc

AMAZZONIA - Grip

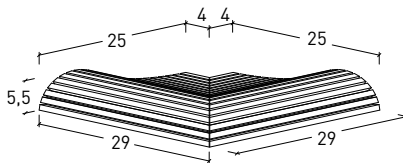

9667 - Pool Wave

2 pc 45° 1+1 pc/box 9,8 kg/pc

AMAZZONIA - Grip*

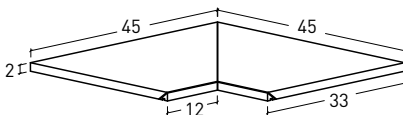

9568

2 pc 45° 1+1 pc/box 5,6 kg/pc

AMAZZONIA - Grip

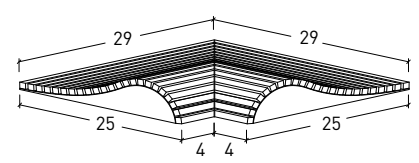

9668 - Pool Wave

2 pc 45° 1+1 pc/box 9,8 kg/pc

AMAZZONIA - Grip*

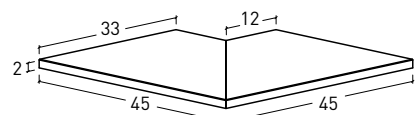
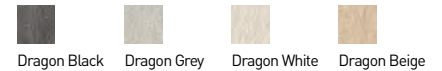

9567

2 pc 45° 1+1 pc/box 5,6 kg/pc

AMAZZONIA - Grip



* Colori Dragon Green, Dragon Brown, Eldorado su richiesta Colours Dragon Green, Dragon Brown, Eldorado on request Coloris Dragon Green, Dragon Brown, Eldorado sur demande Farben Dragon Green, Dragon Brown, Eldorado Auf Anfrage

GRIGLIE IN CERAMICA PARALLELE PARALLEL CERAMIC GRATINGS GRILLES CÉRAMIQUES PARALLELES PARALLELE ROSTE AUS KERAMIK

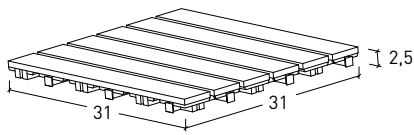

9842 (1)

6 pc/box 2,3 kg/pc

AMAZZONIA - Grip*

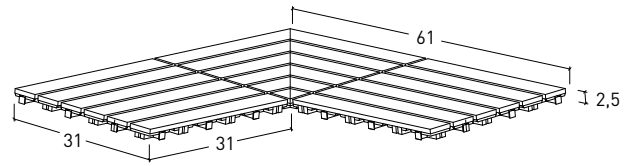

9843 (1)

2 pc 45° 2+2 pc/box 7,9 kg/pc

AMAZZONIA - Grip*



GRIGLIE IN CERAMICA PERPENDICOLARI PERPENDICULAR CERAMIC GRATINGS GRILLES CÉRAMIQUES PARALLELES RECHTWINKLIGE ROSTE AUS KERAMIK

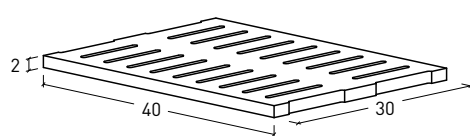

9883 (1)(2)(3)

4 pc/box 5,0 kg/pc

AMAZZONIA - Grip

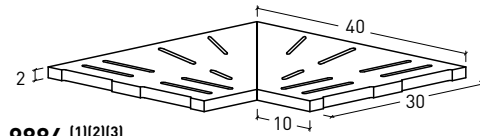

9884 (1)(2)(3)

2 pc 45° 2+2 pc/box 4,5 kg/pc

AMAZZONIA - Grip



GRIGLIE IN CERAMICA PER CANALETTE SPIAGGIA PERPENDICULAR CERAMIC GRATINGS FOR DECK CHANNELS GRILLES CÉRAMIQUES PARALLELES POUR CANIVEAUX DE PLAGE RECHTWINKLIGE ROSTE AUS KERAMIK FÜR STRANDRINNEN EMPFOHLEN

Vedi pagina: See page: Voir page: Siehe Seite: **189**

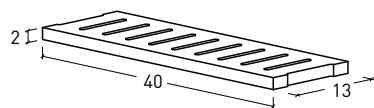

9885 (2)(4)

Padana-Deck 8 pc/box 2,0 kg/pc

AMAZZONIA - Grip

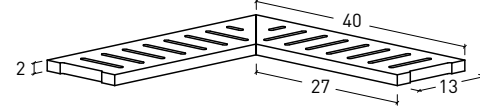

9886 (2)(4)

Padana-Deck 2 pc 45° 4+4 pc/box 3,5 kg/pc

AMAZZONIA - Grip



SUPPORTI GRIGLIA GRATING SUPPORTS SUPPORTS DE GRILLE ROSTAUFLAGER

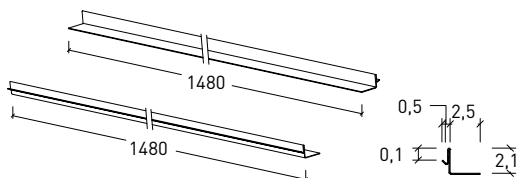

SL20 - IR16[▲]

Supporto griglia in acciaio inox Stainless steel grating support
Support de grille inox Rostträger aus Edelstahl

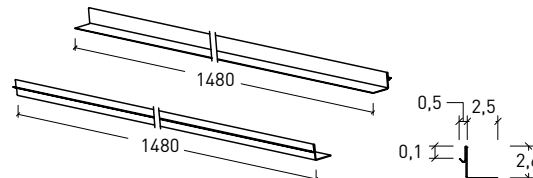

SL25 - IR16[▲]

Supporto griglia in acciaio inox Stainless steel grating support
Support de grille inox Rostträger aus Edelstahl

[▲] Articoli realizzati con acciaio inox AISI 316L-BA - EN 1.4404 (Lucido) / Classe di corrosività C4 Items made with stainless steel AISI 316L-BA - EN 1.4404 (Polished) / Corrosion Class C4 Références fabriquées en acier inox AISI 316L-BA - EN 1.4404 (Poli) / Catégorie de corrosivité C4 Artikeln aus Edelstahl AISI 316L-BA - EN 1.4404 (Glanzend) / Korrosionsklasse C4

⁽¹⁾ Idoneità e geometria della griglia da verificare con i professionisti incaricati della progettazione della piscina e dei relativi impianti Adequacy and geometry of the grating to be approved by the specialists in charge of the designing of the pool and of the related equipment Adéquation et géométrie de la grille à bien vérifier par les responsables de la conception de la piscine et des installations associées Eignung und Geometrie des Gitters sind mit den Fachleuten zu überprüfen, die für die Gestaltung des Pools und seiner Systeme verantwortlich sind

⁽²⁾ Consigliata solo per piscine private Suggested for private pools only Conseillée uniquement pour piscines privées Nur für private Schwimmbäder

⁽³⁾ Fornito con rete di sicurezza sul retro Supplied with safety mesh on the back Fournie avec treillis de sécurité à l'arrière Lieferung mit Sicherheitsnetz auf der Rückseite

⁽⁴⁾ Consigliata solo per canalette di spiaggia Recommended for deck channels only Conseillée uniquement pour caniveaux de plage Nur für Strandrinnen empfohlen

* Colori Dragon Green, Dragon Brown, Eldorado su richiesta Colours Dragon Green, Dragon Brown, Eldorado on request Coloris Dragon Green, Dragon Brown, Eldorado sur demande
Farben Dragon Green, Dragon Brown, Eldorado Auf Anfrage

PIASTRELLE DI INDICAZIONE MARKING TILES CARREAUX NUMEROTES ANZEIGEFLEISEN

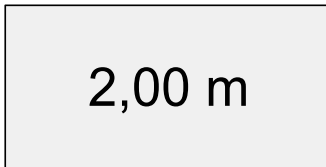

D400

Formato 30x60. Carattere Arial Narrow (altezza 7 cm - spessore 7mm)
 Size 30x60. Font Arian Narrow (height 7 cm - width 7 mm)
 Format 30x60. Caractère Arial Narrow (hauteur 7 cm - largeur 7 mm)
 Format 30x60. Schrifttyp Arial Narrow (Schriftöhe 7 cm - Schriftdicke 7 mm)

AMAZZONIA - Naturale/Grip



CANALETTA CERAMICA LINEARE CP007 ASSEMBLATA SU RETE LINEAR CERAMIC CHANNEL CP007 ASSEMBLED ON MESH
 CANIVEAU CERAMIQUE LINEAIRE CP007 ASSEMBLE SUR TREILLIS LINEARKERAMISCHE RINNE CP007 AUF NETS GEKLEBT

Vedi pagina: See page: Voir page: Siehe Seite: 185

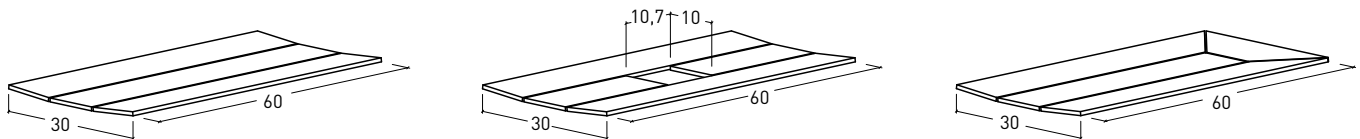

9795[▲]

Padana-Deck 6 pc/box 10,0 kg/pc

AMAZZONIA*



9796[▲]

Padana-Deck 6 pc/box 9,8 kg/pc

AMAZZONIA*



9797[▲]

Padana-Deck 6 pc/box 9,8 kg/pc

AMAZZONIA*



[▲] Fornito assemblato su rete, da posizionarsi/inclinarsi in opera. Assemblaggio ad inclinazione flessibile fino a max 10%
 Supplied on mesh to be positioned/adapted on site. Assembly with flexible slope up to max 10%
 Fourni assemble sur trame, a positionner/incliner sur chantier. Assemblage flexible avec pentes jusqu'à 10%
 Wird auf Netz montiert geliefert, auf der Baustelle zu positionieren neigen. Flexibel Montage mit Neigungen bis max 10%

* Colori Dragon Green, Dragon Brown, Eldorado su richiesta Colours Dragon Green, Dragon Brown, Eldorado on request Coloris Dragon Green, Dragon Brown, Eldorado sur demande
 Farben Dragon Green, Dragon Brown, Eldorado Auf Anfrage



Sistema Finlandese

FINNISH SYSTEM
SYSTEME FINLANDAIS
SYSTEM FINNLAND

BORDI FINLANDESE SENZA AGGRAPPO FINNISH POOL BORDERS WITHOUT FINGER GRIP TÊTES FINLANDAISES SANS ACCROCHE DOIGTS
BECKENKÖPFEN FINNLAND OHNE HANDFASS

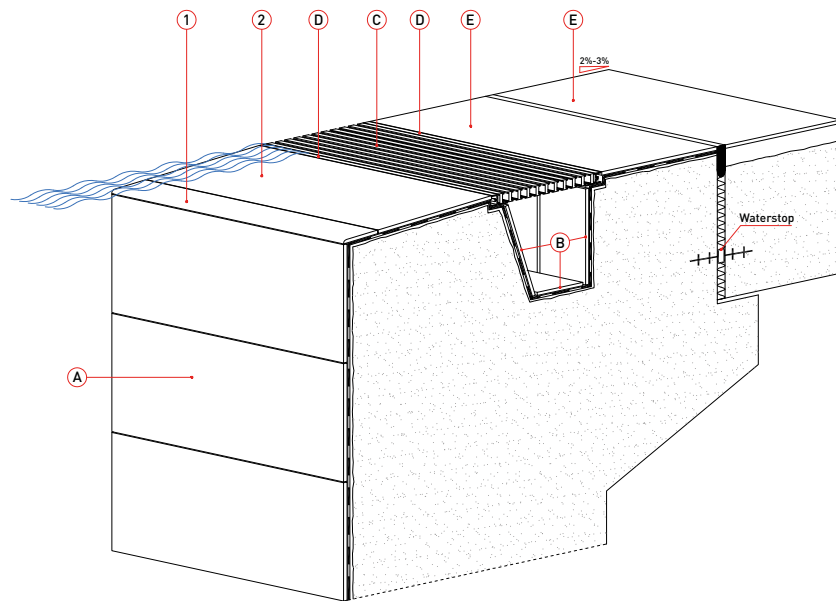

mod. FAMZ 002.3

- A** AMAZZONIA - Naturale_interno vasca / pool tank / interieur bassin / becken
- B** LANDSCAPE - Satin_canaletta di ricircolo / overflow channel / caniveau eau bassin / rinne
- C** PADANA GRID_griglia in pvc / grating in pvc / grille en pvc / pvc rost
- D** PADANA GRID_angolare in pvc / pvc grating support / corniere en pvc / pvc rost traeger
- E** AMAZZONIA - Grip_esterno vasca / pool surround / plage / beckenumgang

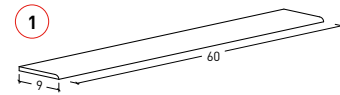

Bordo / Terminale Gradino B.C. 9x60

AMAZZONIA - Grip

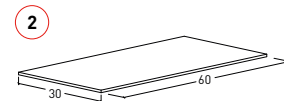

Amazzonio Grip 30x60

AMAZZONIA - Grip

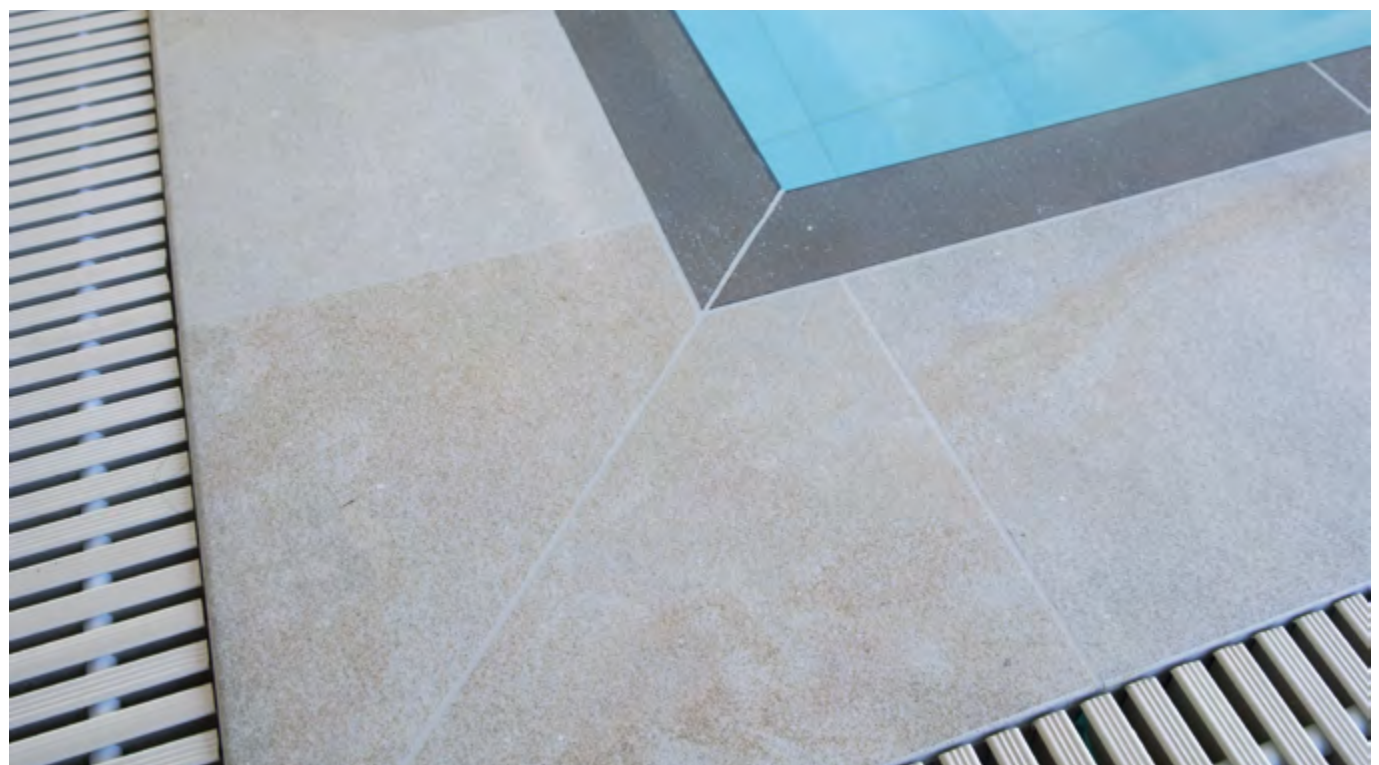

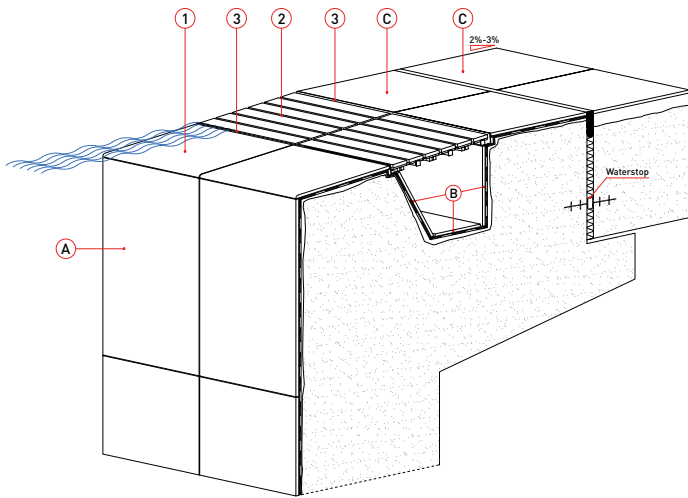

mod. FAMZ 002.6

- A** AMAZZONIA - Naturale_interno vasca / pool tank / interieur bassin / becken
- B** AMAZZONIA - Naturale_canaletta di ricircolo / overflow channel / caniveau eau bassin / rinne
- C** AMAZZONIA - Grip_esterno vasca / pool surround / plage / beckenumgang

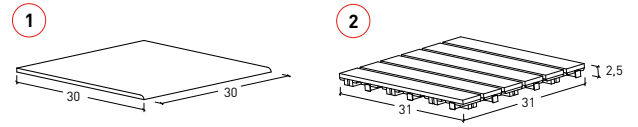

Gradino B.C. Grip 30x30 senza righe 9842

AMAZZONIA - Grip

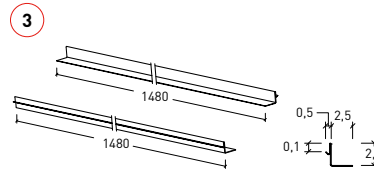

SL25 - IR16

Supporto griglia in acciaio inox
Stainless steel grating support
Support de grille inox
Rostträger aus Edelstahl

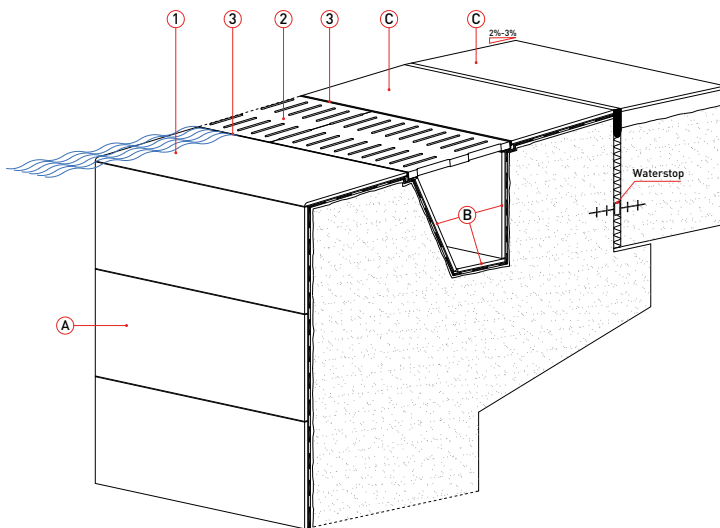

mod. FAMZ 002.7*

- A** AMAZZONIA - Naturale_interno vasca / pool tank / interieur bassin / becken
- B** AMAZZONIA - Naturale_canaletta di ricircolo / overflow channel / caniveau eau bassin / rinne
- C** AMAZZONIA - Grip_esterno vasca / pool surround / plage / beckenumgang

* Consigliato solo per piscine private / Suggested for private pools only /
Conseillées seulement pour piscines privées / Nur für private Schwimmbäder

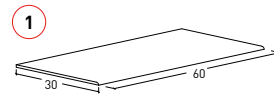

Gradino B.C. Grip 30x60 senza righe

AMAZZONIA - Grip

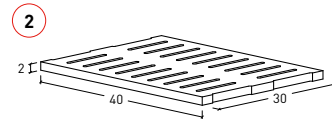

9883

AMAZZONIA - Grip

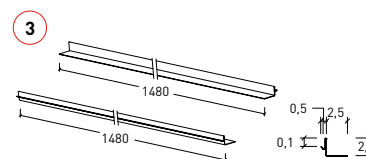

SL20 - IR16

Supporto griglia in acciaio inox
Stainless steel grating support
Support de grille inox
Rostträger aus Edelstahl

AMAZZONIA

BORDI FINLANDESE CON AGGRAPPO FINNISH POOL BORDERS WITH FINGER GRIP TÊTES FINLANDAISES AVEC ACCROCHE DOIGTS BECKENKÖPFEN FINNLAND MIT HANDFASS

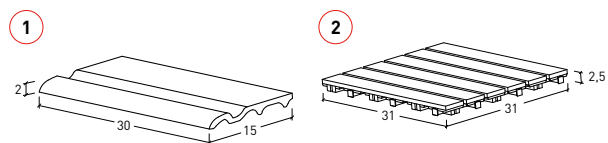
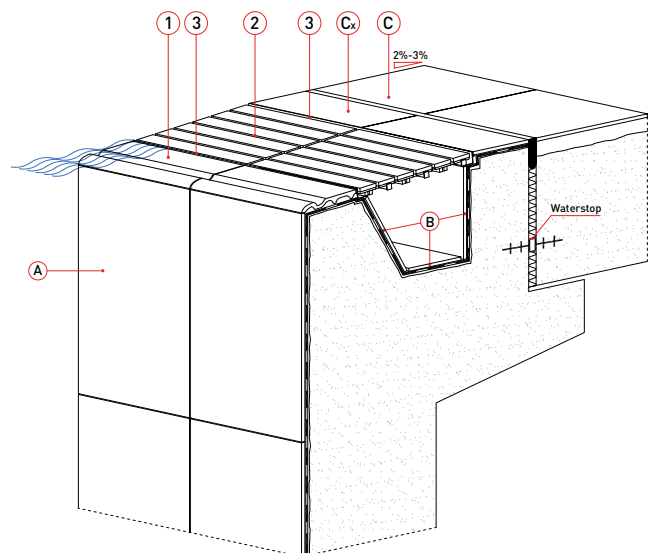

9846

AMAZZONIA - Grip



9842

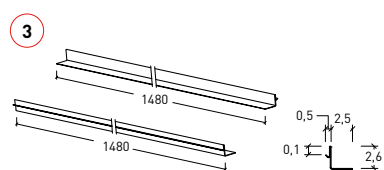

SL25 - IR16

Supporto griglia in acciaio inox / Stainless steel grating support / Support de grille inox / Rostträger aus Edelstahl

mod. FAMZ 001.3

- A** AMAZZONIA - Naturale_interno vasca / pool tank / interieur bassin / becken
- B** AMAZZONIA - Naturale_canaletta di ricircolo / overflow channel / caniveau eau bassin / rinne
- C** AMAZZONIA - Grip_esterno vasca / pool surround / plage / beckenumgang

x = Dimensione variabile dell'articolo, da tagliare in cantiere
Item with variable dimensions, to be cut on site
Dimensions de l'article variables, à couper sur le chantier
Variable Größe des Artikels, vor Ort zu schneiden

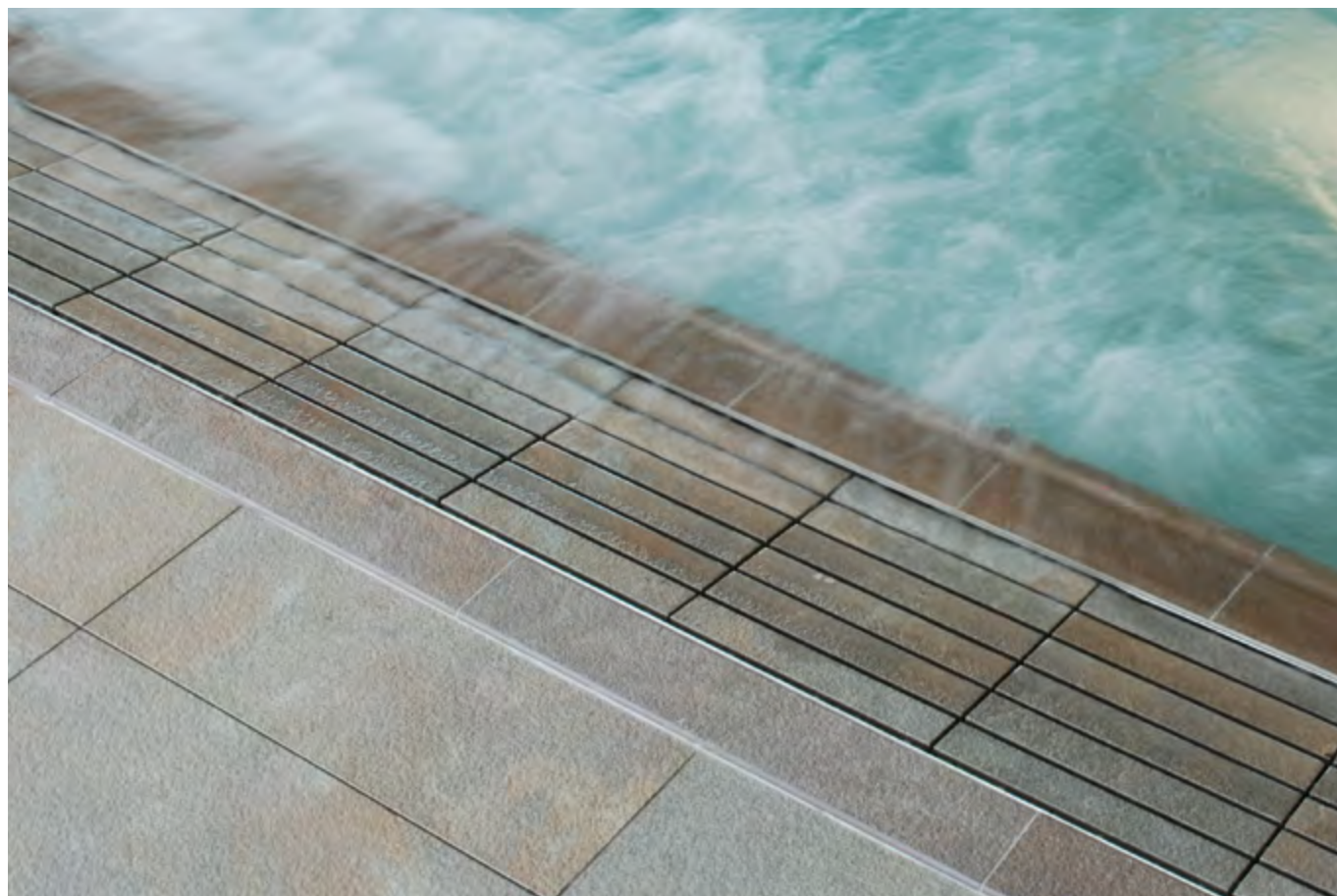

sistema finlandese / finnish system / système finlandais / system finland
 sistema wiesbaden / wiesbaden system / système wiesbaden / system wiesbaden

Sistema Wiesbaden

WIESBADEN SYSTEM
 SYSTEME WIESBADEN
 SYSTEM WIESBADEN

BORDI WIESBADEN A PAVIMENTO WIESBADEN POOL BORDERS HIGH-LEVEL TÊTES WIESBADEN SURFLOT BECKENKÖPFEN WIESBADEN HOCHLIEGEND

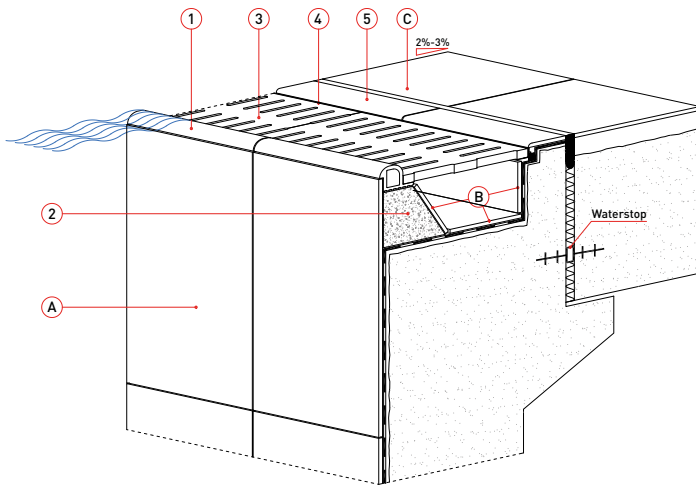

mod. WAMZ 001.1*

- A AMAZZONIA - Naturale_interno vasca / pool tank / interieur bassin / becken
- B AMAZZONIA - Naturale_canaletta di ricircolo / overflow channel / caniveau eau bassin / rinne
- C AMAZZONIA - Grip_esterno vasca / pool surround / plage / beckenumgang

* Consigliato solo per piscine private / Suggested for private pools only /
 Conseillées seulement pour piscines privées / Nur für private Schwimmbäder

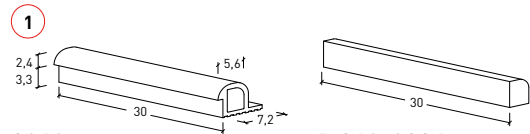

9860

Trim-Box

P 310-0296

Polyfill profilo / profile / profil / Profil*

* Vedi pagina: See page: Voir page: Siehe Seite: 36

AMAZZONIA

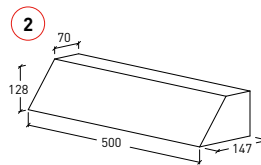

6415

Betonbuild

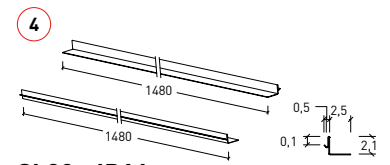

SL20 - IR16

Supporto griglia in acciaio inox
 Stainless steel grating support
 Support de grille inox
 Rostrträger aus Edelstahl

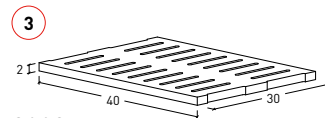

9883

AMAZZONIA - Grip

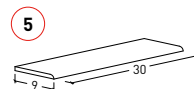

Bordo / Terminale Gradino B.C. 9x30

AMAZZONIA - Grip



AMAZZONIA

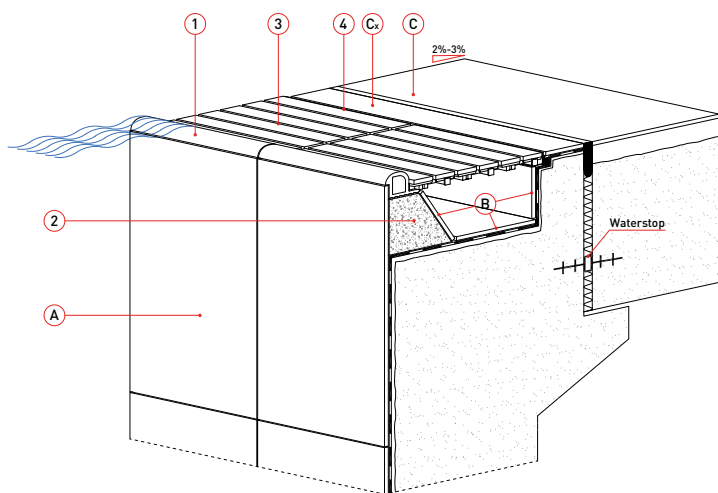

mod. WAMZ 001.2

- A** AMAZONIA - Naturale_interno vasca / pool tank / interieur bassin / becken
- B** AMAZONIA - Naturale_canaletta di ricircolo / overflow channel / caniveau eau bassin / rinne
- C** AMAZONIA - Grip_esterno vasca / pool surround / plage / beckenumgang

x = Dimensione variabile dell'articolo, da tagliare in cantiere
 Item with variable dimensions, to be cut on site
 Dimensions de l'article variables, à couper sur le chantier
 Variable Größe des Artikels, vor Ort zu schneiden

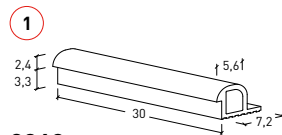

9860
Trim-Box

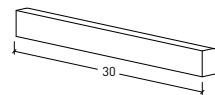

P 310-0296
Polyfill profilo / profile / profil / Profil*

* Vedi pagina: See page: Voir page: Siehe Seite: 36

AMAZZONIA

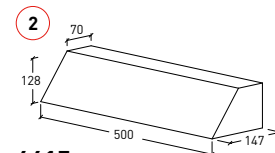

6415
Betonbuild

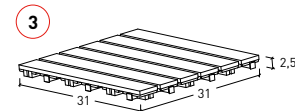

9842

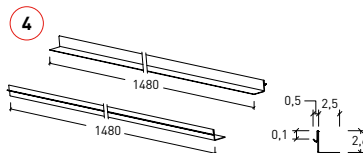

SL25 - IR16

Supporto griglia in acciaio inox / Stainless steel grating support /
 Support de grille inox / Rostträger aus Edelstahl

BORDO WIESABADEN A PARETE WIESBADEN POOL BORDER LOW-LEVEL TÊTE WIESBADEN EN PAROI BECKENKOPF WIESBADEN TIEFLIEGEND

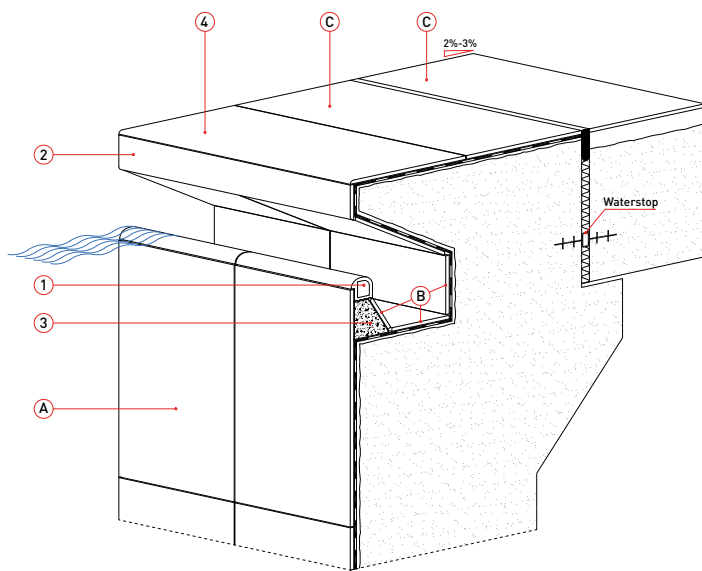

mod. WAMZ 005.1

- A** AMAZONIA - Naturale_interno vasca / pool tank / interieur bassin / becken
- B** AMAZONIA - Naturale_canaletta di ricircolo / overflow channel / caniveau eau bassin / rinne
- C** AMAZONIA - Grip_esterno vasca / pool surround / plage / beckenumgang

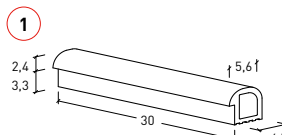

9850
Trim-Box

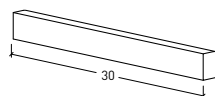

P 310-0296
Polyfill profilo / profile / profil / Profil*

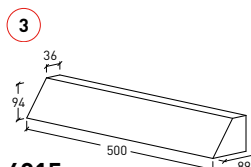

6315
Betonbuild

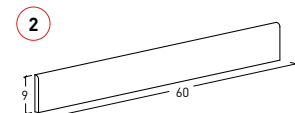

Battiscopa B.C. 9x60

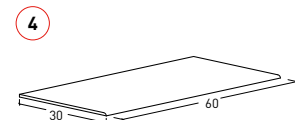

Gradino B.C. Grip 30x60 senza righe

AMAZZONIA



* Vedi pagina: See page: Voir page: Siehe Seite: 36

sistema wiesbaden / wiesbaden system / système wiesbaden / system wiesbaden
 sistema a skimmer / skimmer system / système skimmers / system skimmer

Sistema a Skimmer

SKIMMER SYSTEM
 SYSTEME SKIMMERS
 SYSTEM SKIMMER

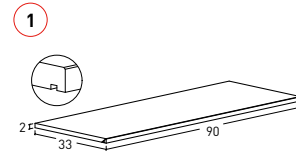
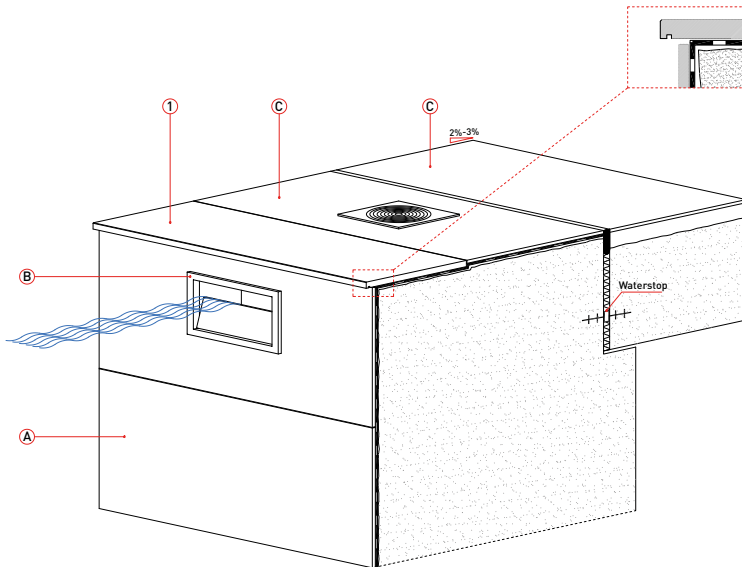

9560

AMAZZONIA - Grip



mod. SKAMZ 9560

- A AMAZZONIA - Naturale_interno vasca / pool tank / interieur bassin / becken
- B Skimmer
- C AMAZZONIA - Grip_esterno vasca / pool surround / plage / beckenumgang

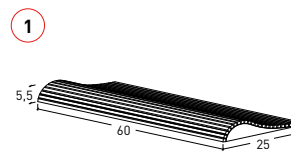
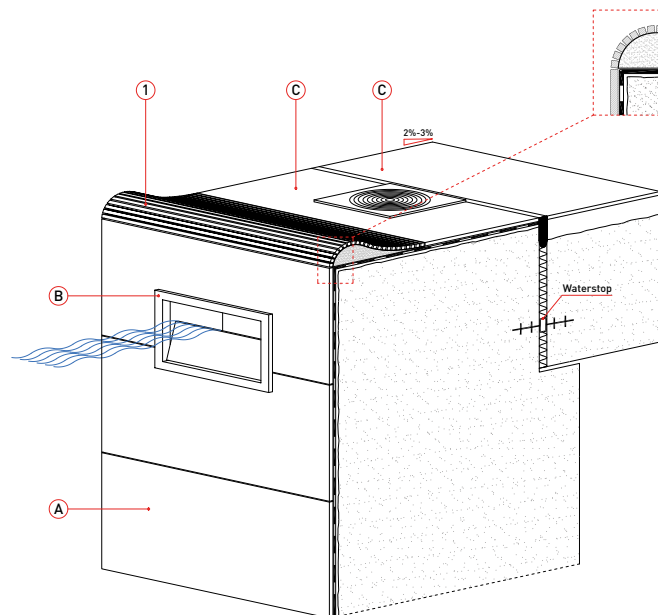

9660 - Pool Wave

AMAZZONIA - Grip



mod. SKAMZ 9660

- A AMAZZONIA - Naturale_interno vasca / pool tank / interieur bassin / becken
- B Skimmer
- C AMAZZONIA - Grip_esterno vasca / pool surround / plage / beckenumgang

AMAZZONIA

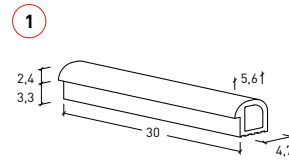
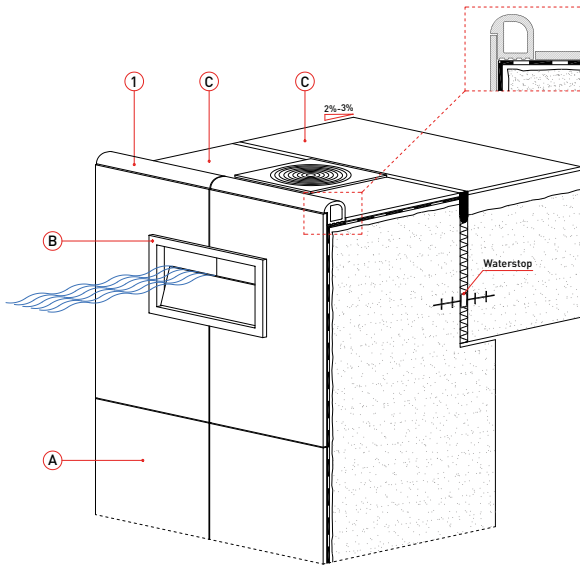

9850

Trim-Box

AMAZZONIA

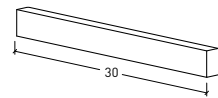

P 310-0296

Polyfill profilo / profile / profil / Profil*

* Vedi pagina: See page: Voir page: Siehe Seite: 36

mod. SKAMZ 9850

- A AMAZONIA - Naturale_interno vasca / pool tank / interieur bassin / becken
- B Skimmer
- C AMAZONIA - Grip_esterno vasca / pool surround / plage / beckenumgang

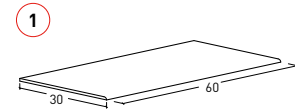
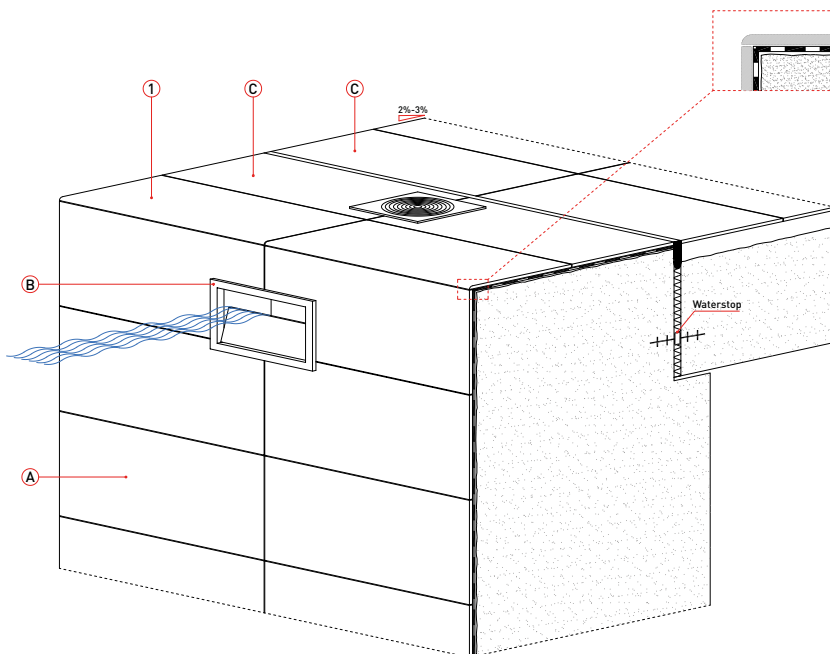

Gradino B.C. Grip 30x60 senza righe

AMAZZONIA - Grip



mod. SKAMZ GRADINO B.C. 30x60

- A AMAZONIA - Naturale_interno vasca / pool tank / interieur bassin / becken
- B Skimmer
- C AMAZONIA - Grip_esterno vasca / pool surround / plage / beckenumgang



Scale e gradini immersi in acqua

IMMERGED STAIRS AND STEPS
 ESCALIERS ET MARCHES IMMERGÉES DANS L'EAU
 TREPPEN UND STUFEN INS WASSER

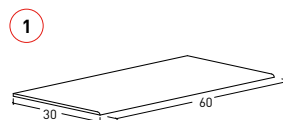
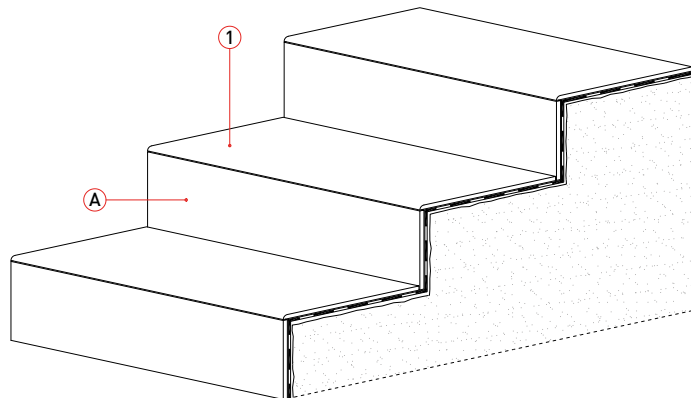

Gradino B.C. Grip 30x60 senza righe

AMAZZONIA - Grip



mod. SCAMZ 08

A AMAZONIA - Naturale
 alzata / tread riser / contrenarche / setz stufe

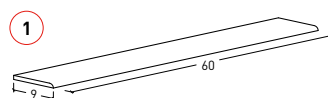
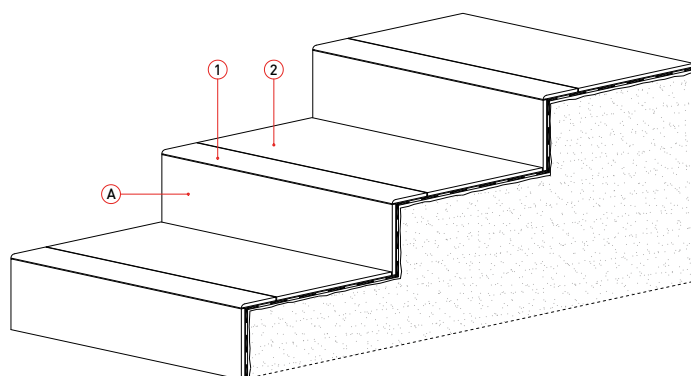

Bordo / Terminale Gradino B.C. 9x60

AMAZZONIA - Grip

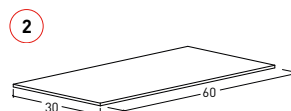

Amazzonia Grip 30x60

AMAZZONIA - Grip



scale e gradini immersi in acqua / immersed stairs and steps / escaliers et marches immergées dans l'eau /
treppen und stufen ins wasser

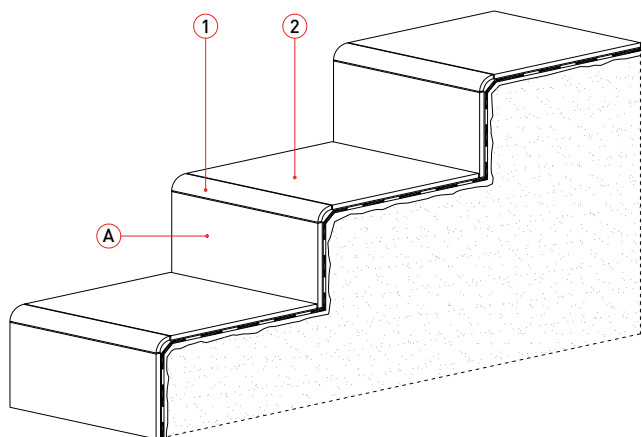

mod. SCAMZ 03

A AMAZZONIA - Naturale
alzata / tread riser / contrenarche / setz stufe

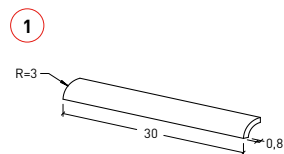

9835

AMAZZONIA - Grip



2

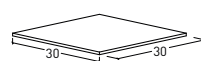

Amazzonia Grip 30x30

AMAZZONIA - Grip



Muretti di testata e muretti

HEADWALLS AND FENCES
 QUAIS DE DÉPART ET MURETS
 STIRNWÄNDE UND MAUERN

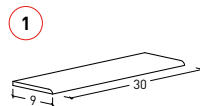
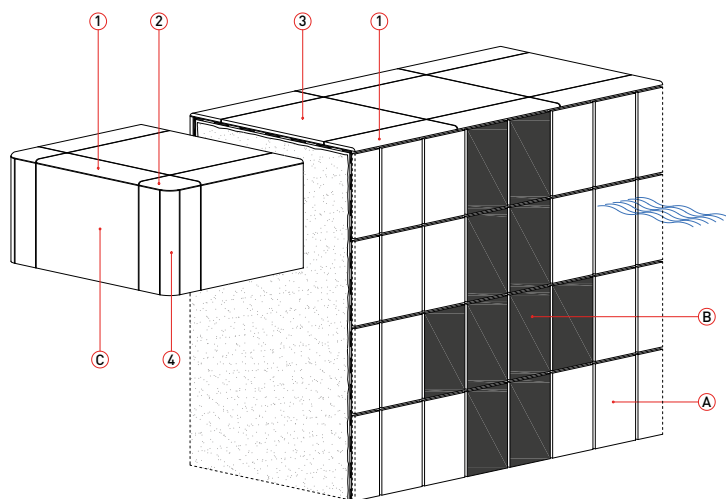

Bordo / Terminale Gradino B.C. 9x30

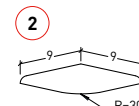

9900 Angolo Bordo / Terminale Gradino B.C. 9x9

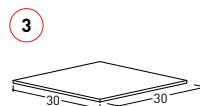

Amazzonia Grip 30x30

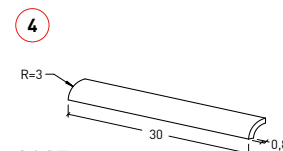

9835

AMAZZONIA - Grip



mod. QDAMZ 01

- A** LANDSCAPE - Friction_fascia di virata / turning area / zone de virage / wandflaeche
- B** LANDSCAPE - Friction_vie di corsa / marking lanes / ligne de nage / bahnamarkierungen
- C** AMAZZONIA - Naturale_rivestimento esterno / external wall / revetement exterieur / wandbekleidung

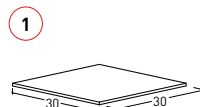
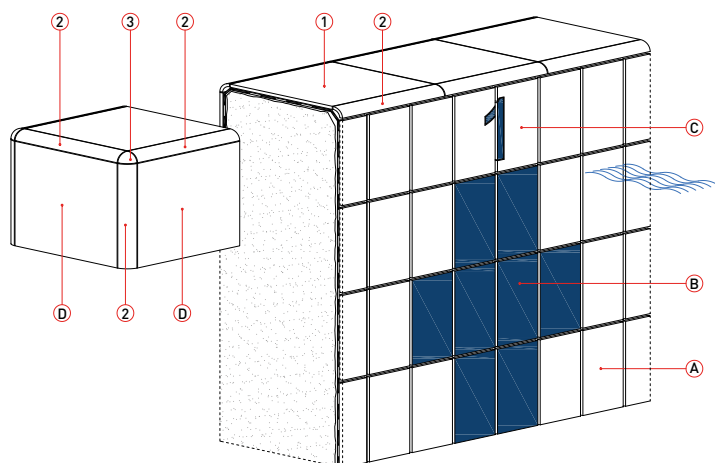

Amazzonia Grip 30x30

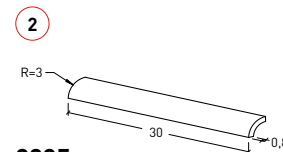

9835

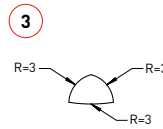

9837

AMAZZONIA - Grip



mod. QDAMZ 02

- A** LANDSCAPE - Friction_fascia di virata / turning area / zone de virage / wandflaeche
- B** LANDSCAPE - Friction_vie di corsa / marking lanes / ligne de nage / bahnamarkierungen
- C** piastrelle numerate / numbered tiles / carreau numerote / nummerierte platte
- D** AMAZZONIA - Naturale_rivestimento esterno / external wall / revetement exterieur / wandbekleidung

muretti di testata e muretti / headwalls and fences / quais de depart et murets / stirnwande und Mauern

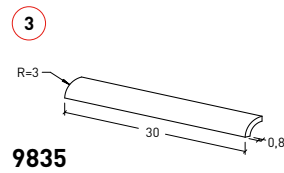
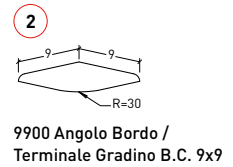
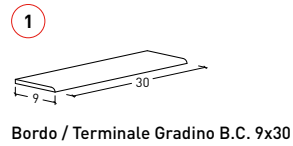
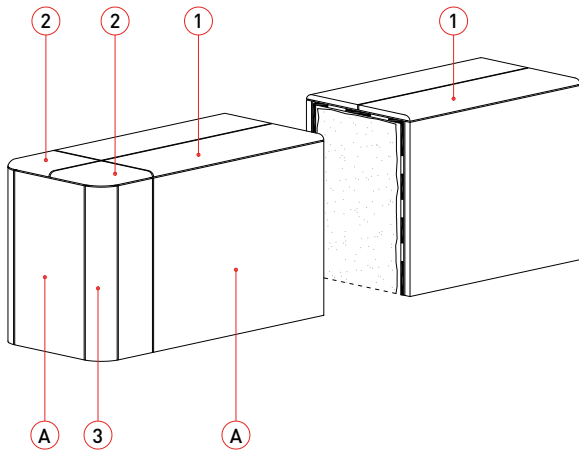

AMAZZONIA - Grip



mod. MUAMZ 01

A AMAZZONIA - Naturale_rivestimento / wall tiling / revetement / wandfliesen

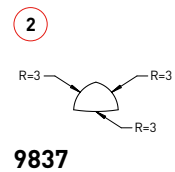
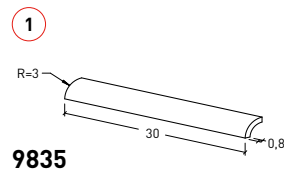
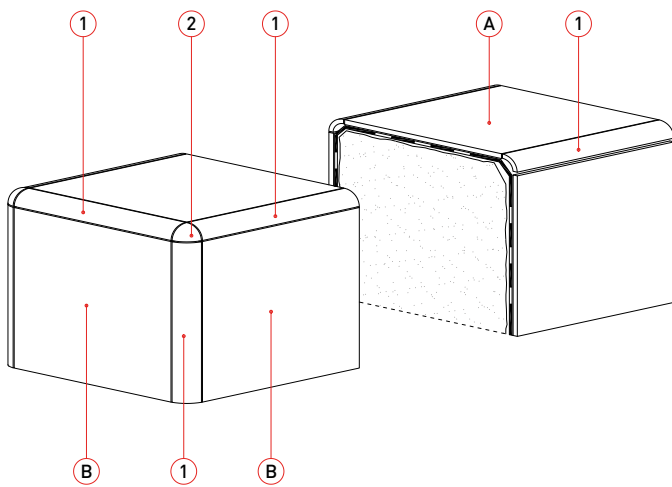

AMAZZONIA - Grip



mod. MUAMZ 02

A AMAZZONIA - Naturale/Grip_rivestimento / wall tiling / revetement / wandfliesen

B AMAZZONIA - Naturale_rivestimento / wall tiling / revetement / wandfliesen

Angoli e spigoli arrotondati

ROUNDED IN-CORNERS AND OUT-CORNERS
 ANGLES SORTANTS ET RENTRANTS ARRONDIS
 GERUNDETE KANTEN UND ECKEN

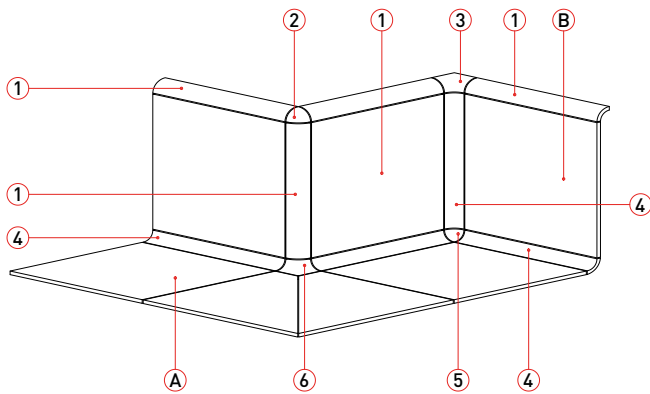

mod. FIAMZ 01

- A** AMAZZONIA Naturale/Grip_pavimento / floor / carrelage de sol / bodenfliesen
- B** AMAZZONIA Naturale_rivestimento / wall tiling / revetement / wandfliesen

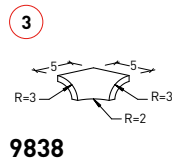
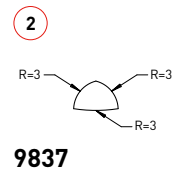
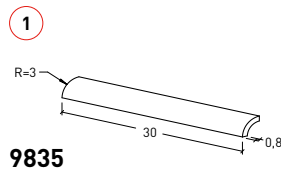

AMAZZONIA

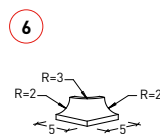
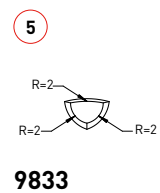
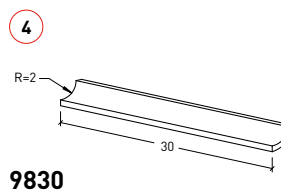

AMAZZONIA



angoli e spigoli arrotondati / rounded in-corners and out-corners / angles sortants et rentrants arrondis / gerundete Kanten und Ecken

vasche lavapiedi / feet washers / pédiluves / durchschreitbecken

Vasche lavapiedi

FEET WASHERS
PÉDILUVES
DURCHSCHREITBECKEN

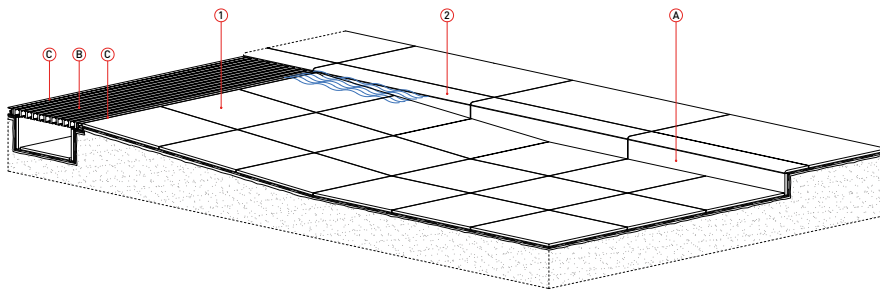

1



Amazzonia Grip 30x30

2

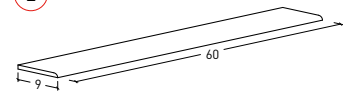

Bordo / Terminale Gradino B.C. 9x60

AMAZZONIA - Grip



Dragon Black



Dragon Grey



Dragon White



Dragon Beige

mod. PEAMZ 01

- A AMAZZONIA - Naturale_rivestimento / wall tiling / revetement / wandfliesen
- B PADANA GRID_griglia in pvc / grating in pvc / grille en pvc / pvc rost
- C PADANA GRID_angolare in pvc / pvc grating support / corniere en pvc / pvc rost traeger

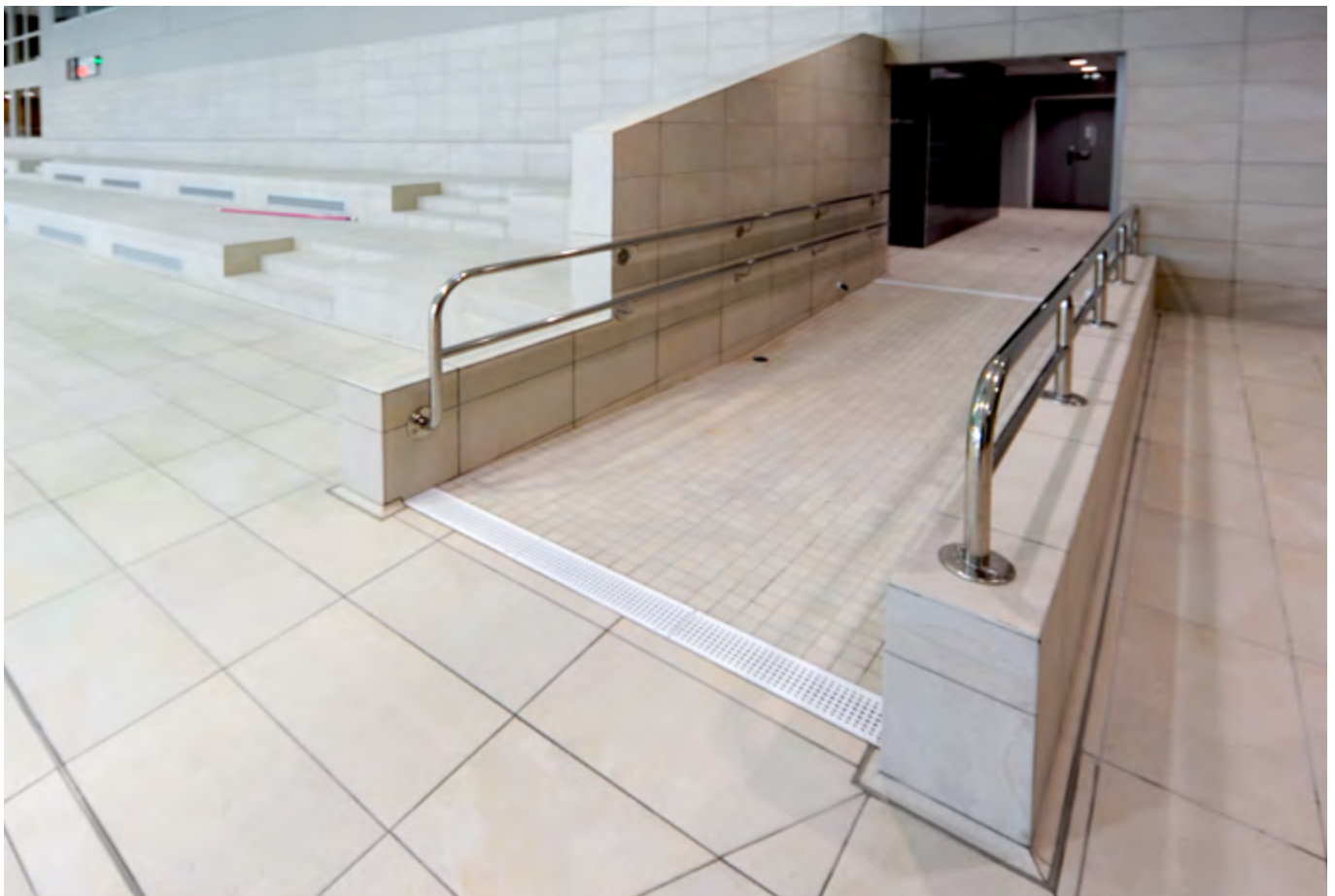

Country Wood

GRANITOKER

Country Ice



Country Bianco



Country Greige



Country Marrone

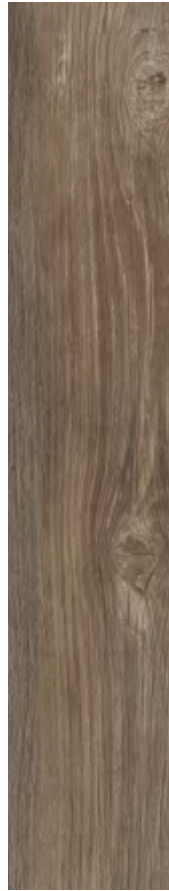

Country Tortora

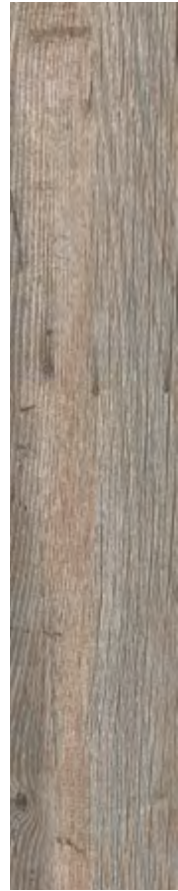

Accentuata
Accentuated
Importante
Starke

Vedi pagina: See page: Voir page: Siehe Seite: 209



cm 20x120
7^{7/8}"x47^{1/4}"



cm 40x120
15^{3/4}"x47^{1/4}"



cm 60x120
23^{5/8}"x47^{1/4}"



cm 25x151
9^{7/8}"x59^{1/2}"

Formati Sizes
Formats Formate

Spessori Thicknesses
Epaisseurs Stärken

mm 9

mm 20

mm 9

mm 10

Superfici Surfaces
Surfaces Oberflächen



● Naturale ^[1]

● Grip ^[2]

DIN 51130 XP P 05-010
R 10 PC 10



DIN 51097 XP P 05-010
B PN 18



DIN 51130 XP P 05-010
R 11 PC 20



Rettificate in un unico calibro Rectified version in a single caliber Rectifiés en un unique calibre Boden Sie in einem einzigen Kaliber

^[1] A pavimento: zone asciutte Floor: dry zones Revêtement de sol : zones sèches Boden: trokenzonen

^[2] A pavimento: zone asciutte e zone umide Floor: dry zones and wet zones Revêtement de sol : zones sèches et zones humides Boden: trokenzonen und feuchenzonen

Caratteristiche tecniche a pagina: Technical features on page: Caractéristiques techniques à la page: Technische Eigenschaften auf Seite: 208

colori / colours / couleurs / farben
decori e pezzi speciali / decors and fittings / decorations et pieces speciales / dekore und formstucke

BATTISCOPA SKIRTING BORD ARRONDI SOCKEL

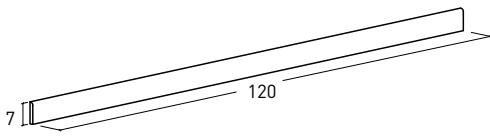

Battiscopa B.C. 9x120

8 pc/box 1,21 kg/pc

COUNTRY WOOD - Naturale



GRADONI E BORDI VASCA SKIMMER STEPS AND SKIMMER POOL BORDERS MARCHES ET TÊTES DE BASSIN SKIMMER STUFEN UND BECKENKÖPFE SKIMMER

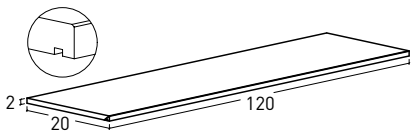

9690

3 pc/box 11 kg/pc

COUNTRY WOOD - Grip



9691

2 pc 45° 2+2 pc/box 5,5 kg/pc

COUNTRY WOOD - Grip



9692

2 pc 45° 2+2 pc/box 5,5 kg/pc

COUNTRY WOOD - Grip



GRIGLIE IN CERAMICA PERPENDICOLARI PER CANALETTE SPIAGGIA PERPENDICULAR CERAMIC GRATINGS FOR DECK CHANNELS
GRILLES CÉRAMIQUES PARALLELES POUR CANIVEAU DE PLAGE RECHTWINKLIGE ROSTE AUS KERAMIK FÜR STRANDRINNEN EMPFOHLEN

Vedi pagina: See page: Voir page: Siehe Seite: 189

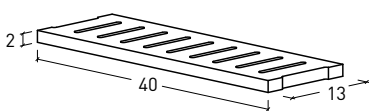

9885 ⁽¹⁾

Padana-Deck 8 pc/box 2,5 kg/pc

COUNTRY WOOD - Grip

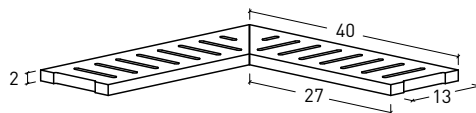

9886 ⁽¹⁾

Padana-Deck 2 pc 45° 4+4 pc/box 2,0 kg/pc

COUNTRY WOOD - Grip



⁽¹⁾ Consigliata solo per piscine private. Consigliata solo per canalette di spiaggia Suggested for private pools only. Recommended for deck channels only
 Conseillée uniquement pour piscines privées. Conseillée uniquement pour caniveaux de plage Nur für private Schwimmbäder. Nur für Strandrinnen empfohlen

Marte

GRANITOGRES

Botticino

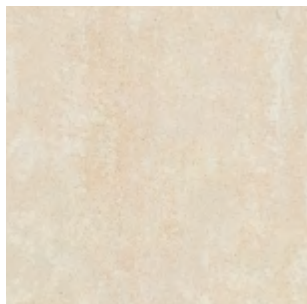

Palissandro



Bronzetto

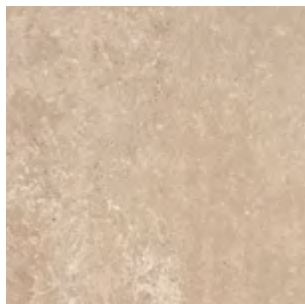

Ramora Brown

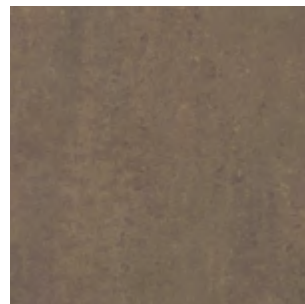

Thassos



Grigio Egeo

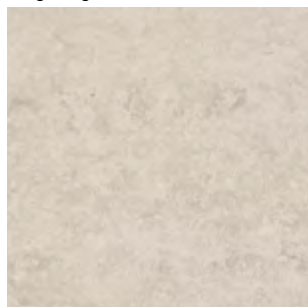

Raggio di Luna

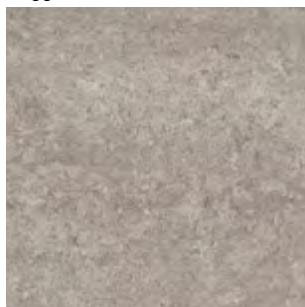

Grigio Marostica

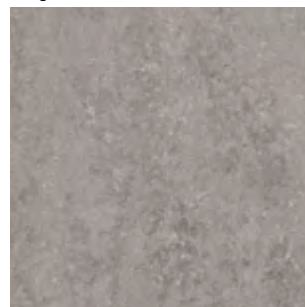

Grigio Maggia



Nero Acapulco

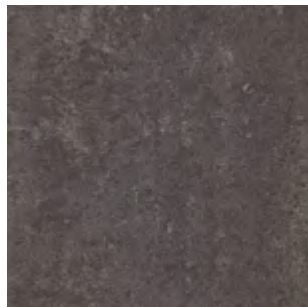

Azul Bahia



Azul Macauba

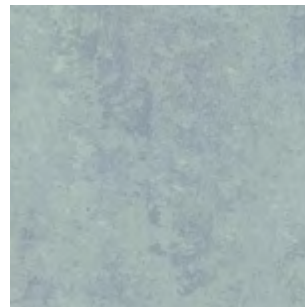







Verde Guatemala





Media
Medium
Modérée
Mittlere

Vedi pagina: See page: Voir page: Siehe Seite: 209





						
Formati Sizes Formats Formate	cm 15x15 5 ^{7/8} "x5 ^{7/8} "	cm 30x30 11 ^{3/4} "x11 ^{3/4} "	cm 15x60 5 ^{7/8} "x23 ^{5/8} "	cm 30x60 11 ^{3/4} "x23 ^{5/8} "	cm 60x60 23 ^{5/8} "x23 ^{5/8} "	cm 60x120 23 ^{5/8} "x47 ^{1/4} "
Spessori Thicknesses* Épaisseurs Stärken	mm 9,4	mm 9,4	mm 9,4	mm 9,4	mm 9,4	mm 9,4
Superfici Surfaces Surfaces Oberflächen	●	● ●	●	● ●	● ●	●

● Naturale ⁽¹⁾

DIN 51097 A	XP P 05-010 PN 12	
DIN 51130 R 9	XP P 05-010 PC 6	

● Bocciardata ⁽²⁾

DIN 51097 B	XP P 05-010 PN 18	
DIN 51130 R 11	XP P 05-010 PC 20	

Rettificata in un unico calibro Rectified version in a single caliber Rectifiés en un unique calibre Boden Sie in einem einzigen Kaliber

* Spessore su superficie naturale Thickness on matt surface Épaisseur sur surface mat Stärke der Fliesen mit Matt Oberfläche

⁽¹⁾ A pavimento: zone asciutte Floor: dry zones Revêtement de sol : zones sèches Boden: trokenzonen

⁽²⁾ A pavimento: zone asciutte e zone umide Floor: dry zones and wet zones Revêtement de sol : zones sèches et zones humides Boden: trokenzonen und feuchtnzonen

Caratteristiche tecniche a pagina: Technical features on page: Caractéristiques techniques à la page: Technische Eigenschaften auf Seite: **204**

MARTE

MOSAICI

Mosaico Fresato 3x3



30x30 cm 11^{3/4}"x11^{3/4}"
 3x3 cm 1^{1/8}"x1^{1/8}"
 1,08 m²/box 21,6 kg/m²

Mosaico Monocolore 3x3*

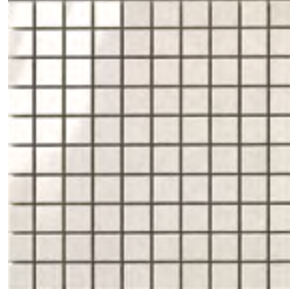

30x30 cm 11^{3/4}"x11^{3/4}"
 3x3 cm 1^{1/8}"x1^{1/8}"

su rete on net sur trame auf Netz

6 pc/box 1,5 kg/pc

Mosaico Texture 3x3*

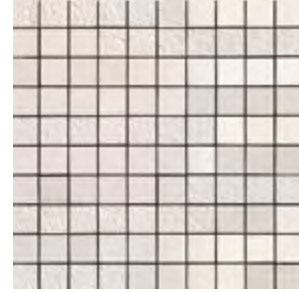

30x30 cm 11^{3/4}"x11^{3/4}"
 3x3 cm 1^{1/8}"x1^{1/8}"

su rete on net sur trame auf Netz

6 pc/box 1,5 kg/pc

MARTE - Naturale/Bocciardata

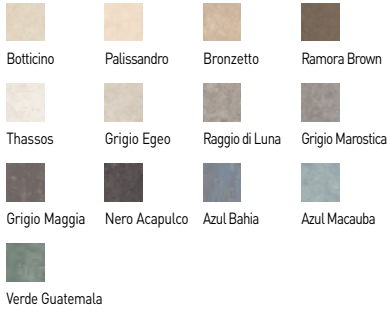

MARTE - Levigata

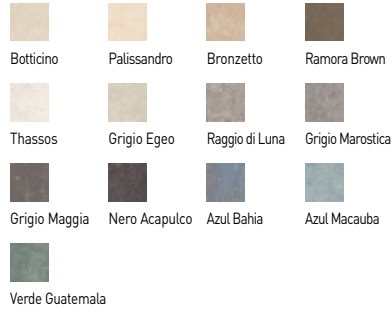

MARTE - Naturale/Levigata/Bocciardata

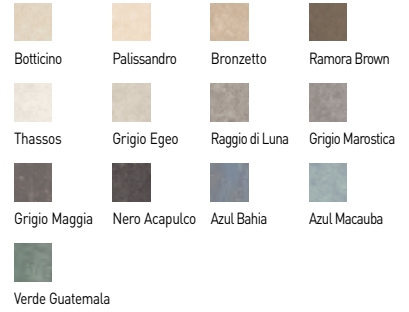

* Vedi dettagli a pagina: See details on page: Voir détails à la page: Siehe Details auf Seite: 210



decori e pezzi speciali / decors and fittings / décorations et pièces spéciales / dekore und formstücke

PEZZI SPECIALI PER PISCINE FITTINGS FOR SWIMMING POOLS PIÈCES SPÉCIALES POUR PISCINES FORMSTÜCKE FÜR SCHWIMMBÄDER

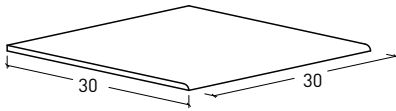

Gradino B.C 30x30 senza righe

12 pc/box 1,67 kg/pc

MARTE - Bocciardata

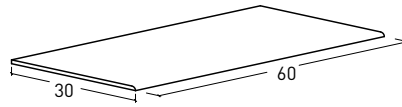
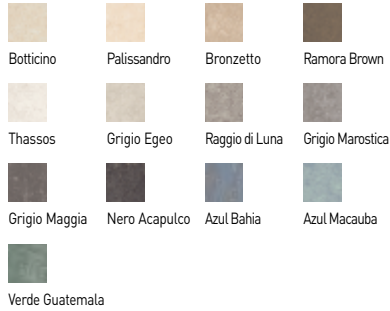

Gradino B.C 30x60 senza righe

6 pc/box 3,89 kg/pc

MARTE - Bocciardata

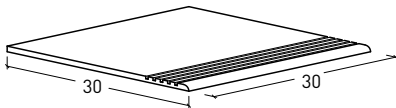
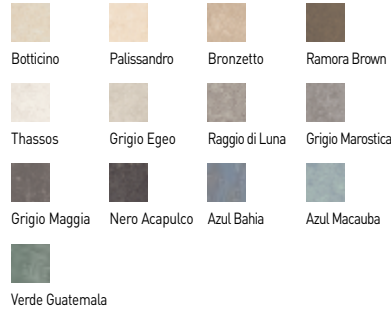

Gradino B.C 30x30 con righe

12 pc/box 1,67 kg/pc

MARTE - Naturale

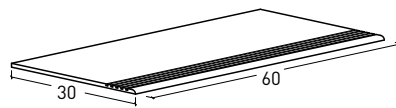
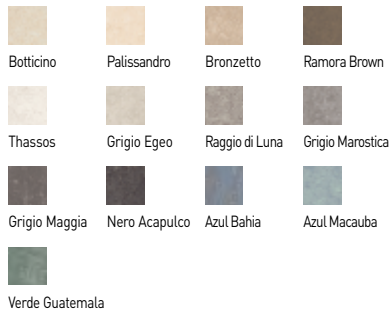

Gradino B.C 30x60 con righe

6 pc/box 3,89 kg/pc

MARTE - Naturale

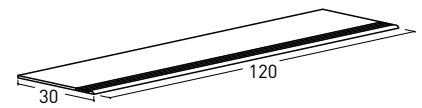
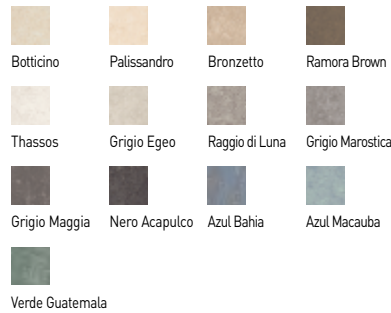

Gradino B.C 30x120 con righe

3 pc/box 8,28 kg/pc

MARTE - Naturale

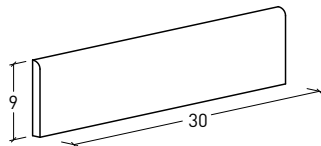
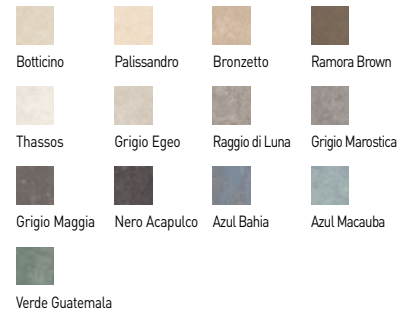

Battiscopa B.C. 9x30

28 pc/box 0,5 kg/pc

MARTE - Naturale

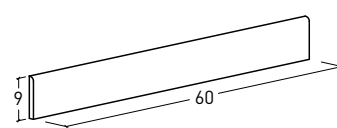
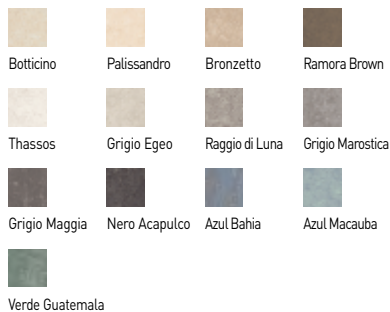

Battiscopa B.C. 9x60

18 pc/box 1,04 kg/pc

MARTE - Naturale

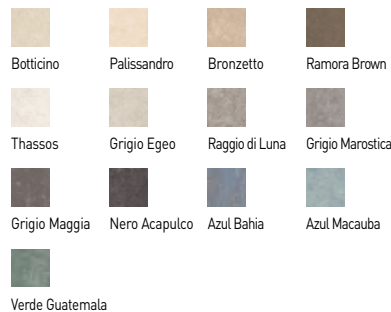

MARTE

PEZZI SPECIALI PER PISCINE FITTINGS FOR SWIMMING POOLS PIÈCES SPÉCIALES POUR PISCINES FORMSTÜCKE FÜR SCHWIMMBÄDER

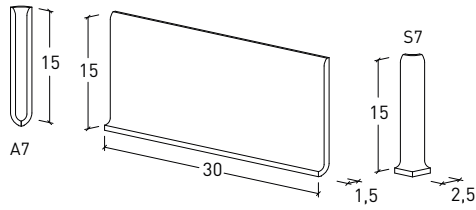

Zoccolo a raccordo B.C. 15x30 + A7 + S7

28 pc/box 0,5 kg/pc

MARTE

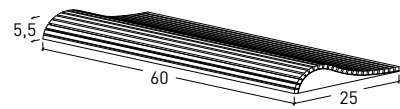
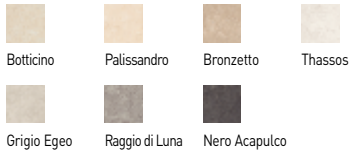

9660 - Pool Wave

1 pc/box 10,0 kg/pc

MARTE - Naturale

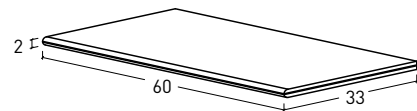
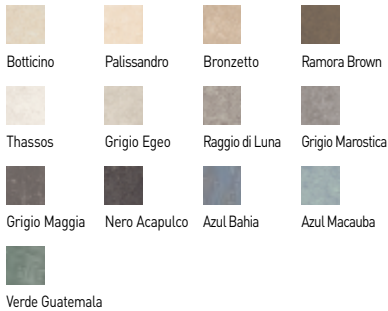

Gradone toro 33x60 senza righe

4 pc/box 9,0 kg/pc

MARTE - Bocciardata

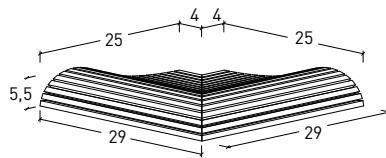
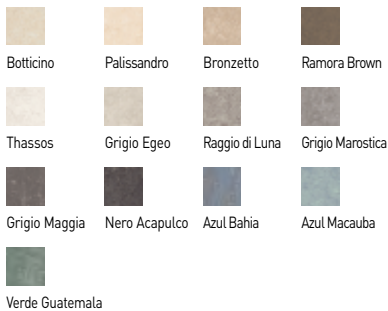

9667 - Pool Wave

2 pc 45° 1+1 pc/box 9,8 kg/pc

MARTE - Naturale

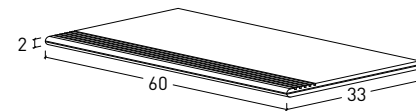
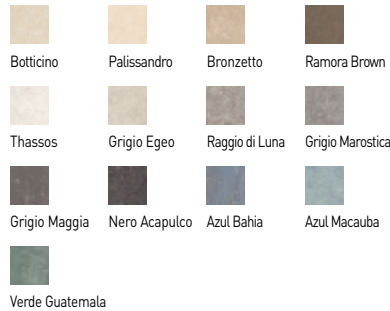

Gradone toro 33x60 con righe

4 pc/box 9,0 kg/pc

MARTE - Naturale

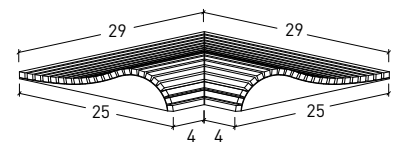
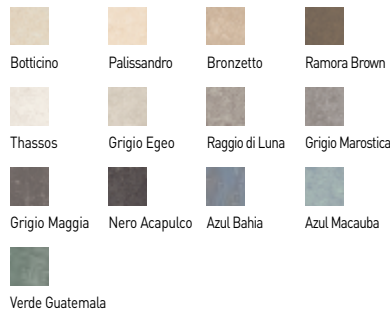

9668 - Pool Wave

2 pc 45° 1+1 pc/box 9,8 kg/pc

MARTE - Naturale

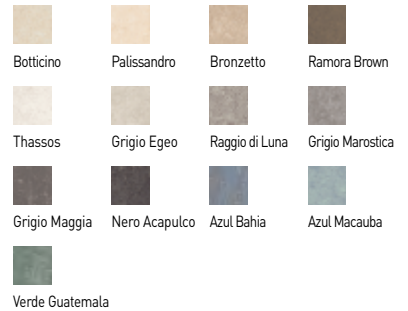

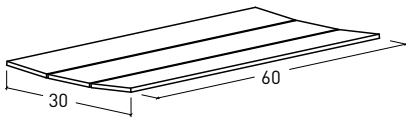

9795*

Padana-Deck 6 pc/box 10,0 kg/pc

MARTE - Bocciardata

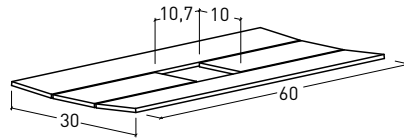
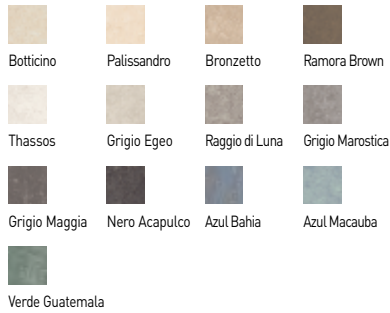

9796*

Padana-Deck 6 pc/box 9,8 kg/pc

MARTE - Bocciardata

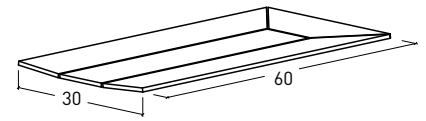
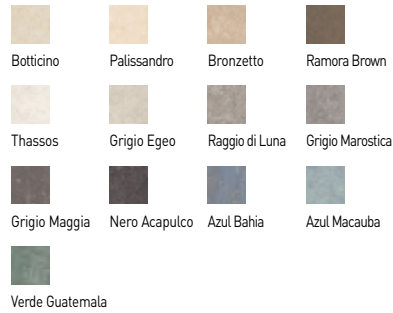

9797*

Padana-Deck 6 pc/box 9,8 kg/pc

MARTE - Bocciardata

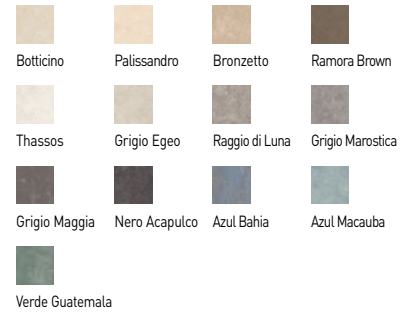

Vedi pagina: See page: Voir page: Siehe Seite: **185**

* Fornito assemblato su rete, da posizionarsi/inclinarsi in opera. Assemblaggio ad inclinazione flessibile fino a max 10%
 Supplied on mesh to be positioned/adapted on site. Assembly with flexible slope up to max 10%
 Fourni assemble sur trame, a positionner/incliner sur chantier. Assemblage flexible avec pentes jusqu'à 10%
 Wird auf Netz montiert geliefert, auf der Baustelle zu positionieren neigen. Flexibel Montage mit Neigungen bis max 10%



Pietre di Sardegna

PIETRE NATIVE

Porto Rotondo

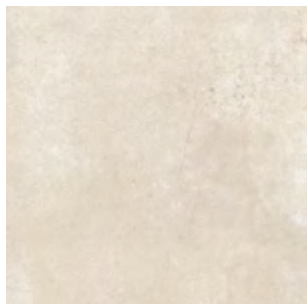

Porto Cervo



Stintino

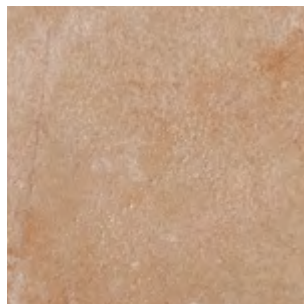

Cala Luna



Punta Molara



Caprera

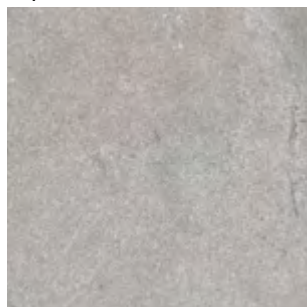



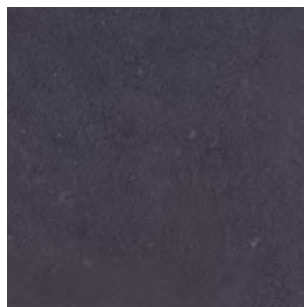

Tavolara







Accentuata
Accentuated
Importante
Starke



Vedi pagina: See page: Voir page: Siehe Seite: 209





				
Formati Sizes Formats Formate	cm 30x30 11 ^{3/4} "x11 ^{3/4} "	cm 30x60 11 ^{3/4} "x23 ^{5/8} "	cm 60x60 23 ^{5/8} "x23 ^{5/8} "	cm 60x60 23 ^{5/8} "x23 ^{5/8} "
Spessori Thicknesses Epaisseurs Stärken	mm 9	mm 10 mm 9	mm 10	mm 20
Cala Luna	●	●	● ●	●
Caprera	●	●	● ●	●
Porto Cervo	●	●	● ●	●
Porto Rotondo	●	●	● ●	●
Punta Molara	●	●	● ●	●
Stintino	●	●	● ●	
Tavolara	●	●	● ●	●

					
Formati Sizes Formats Formate	cm 45x90 17 ^{3/4} "x35 ^{3/8} "	cm 90x90 35 ^{3/8} "x35 ^{3/8} "	cm 90x90 35 ^{3/8} "x35 ^{3/8} "	cm 60x120 23 ^{5/8} "x47 ^{1/4} "	cm 60x120 23 ^{5/8} "x47 ^{1/4} "
Spessori Thicknesses Epaisseurs Stärken	mm 10	mm 10	mm 20	mm 10	mm 20
Cala Luna	●	●	●	●	
Caprera	●	●	●	●	●
Porto Cervo	●	●	●	●	●
Porto Rotondo	●	●	●	●	●
Punta Molara	●	●	●	●	●
Stintino	●	●		●	
Tavolara	●	●	●	●	●

● Naturale ⁽¹⁾

DIN 51097 A	XP P 05-010 PN 12	
DIN 51130 R 10	XP P 05-010 PC 10	

● Grip ⁽²⁾

DIN 51097 B	XP P 05-010 PN 18	
DIN 51130 R 11	XP P 05-010 PC 20	

Rettificate in un unico calibro Rectified version in a single caliber Rectifiés en un unique calibre Boden Sie in einem einzigen Kaliber

⁽¹⁾ A pavimento: zone asciutte Floor: dry zones Revêtement de sol : zones sèches Boden: trokenzonen

⁽²⁾ A pavimento: zone asciutte e zone umide Floor: dry zones and wet zones Revêtement de sol : zones sèches et zones humides Boden: trokenzonen und feuchtzonen

PIETRE DI SARDEGNA

MOSAICI*

Mosaico 3x3

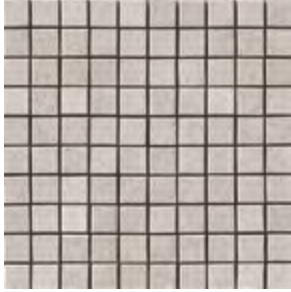

30x30 cm 11^{3/4}"x11^{3/4}"
3x3 cm 1^{1/8}"x1^{1/8}"

su rete on net sur trame auf Netz

1,08 m²/box 21,6 kg/m²

PIETRE DI SARDEGNA - Naturale



Porto Rotondo Porto Cervo Stintino Cala Luna
Punta Molara Caprera Tavolara

Mosaico 6x6



30x30 cm 11^{3/4}"x11^{3/4}"
6x6 cm 2^{3/8}"x2^{3/8}"

su rete on net sur trame auf Netz

6 pc/box 1,53 kg/pc

PIETRE DI SARDEGNA - Naturale



Porto Rotondo Porto Cervo Stintino Cala Luna
Punta Molara Caprera Tavolara

Composizione A



30x60 cm 11^{3/4}"x23^{5/8}"
6 pc/box 3,88 kg/pc

PIETRE DI SARDEGNA - Naturale



Porto Rotondo Porto Cervo Stintino Cala Luna
Punta Molara Caprera Tavolara

* Vedi dettagli a pagina: See details on page: Voir détails à la page: Siehe Details auf Seite: 210

decori e pezzi speciali / decors and fittings / décorations et pièces spéciales / dekore und formstücke

PEZZI SPECIALI PER PISCINE FITTINGS FOR SWIMMING POOLS PIÈCES SPÉCIALES POUR PISCINES FORMSTÜCKE FÜR SCHWIMMBÄDER

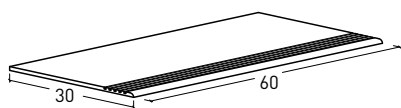

Gradino B.C 30x60 con righe

6 pc/box 3,89 kg/pc

PIETRE DI SARDEGNA - Naturale

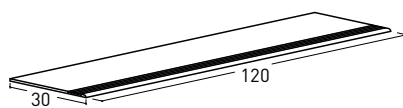

Gradino B.C 30x120 con righe

3 pc/box 8,28 kg/pc

PIETRE DI SARDEGNA - Naturale

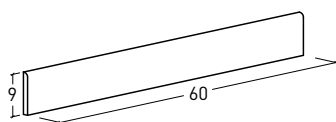

Battiscopa B.C. 9x60

18 pc/box 1,04 kg/pc

PIETRE DI SARDEGNA - Naturale

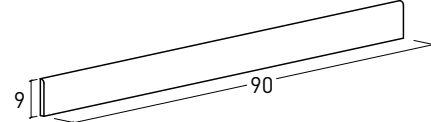

Battiscopa B.C. 9x90

9 pc/box 1,89 kg/pc

PIETRE DI SARDEGNA - Naturale



9550

3 pc/box 9,1 kg/pc

PIETRE DI SARDEGNA - Grip

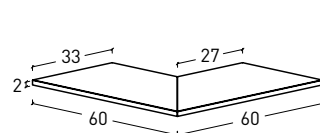

9557

2 pc 45° 1+1 pc/box 9,2 kg/pc

PIETRE DI SARDEGNA - Grip

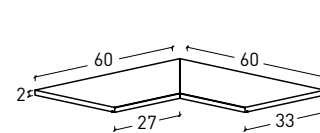

9558

2 pc 45° 1+1 pc/box 9,2 kg/pc

PIETRE DI SARDEGNA - Grip

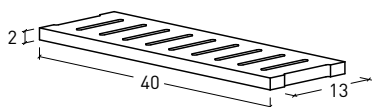
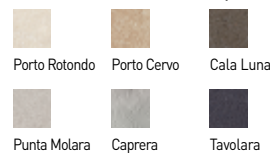

9885 (1)*

Padana-Deck 8 pc/box 2,0 kg/pc

PIETRE DI SARDEGNA - Grip

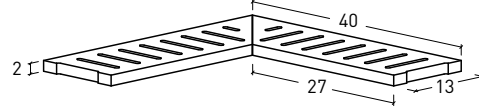

9886 (1)*

Padana-Deck 2 pc 45° 4+4 pc/box 3,5 kg/pc

PIETRE DI SARDEGNA - Grip



* Vedi pagina: See page: Voir page: Siehe Seite: 189

(1) Consigliata solo per piscine private. Consigliata solo per canalette di spiaggia Suggested for private pools only. Recommended for deck channels only. Conseillée uniquement pour piscines privées. Conseillée uniquement pour caniveaux de plage Nur für private Schwimmbäder. Nur für Strandrinnen empfohlen

Pietra Baugé

PIETRE NATIVE

Bianca



Beige

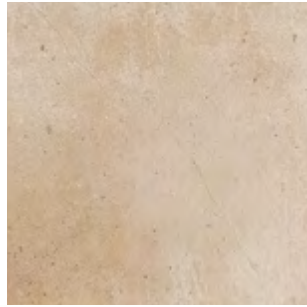

Grigia



Antracite



Accentuata
Accentuated
Importante
Starke

Vedi pagina: See page: Voir page: Siehe Seite: 209

Formati Sizes Formats Formate					
	cm 30x60 11 ^{3/4} "x23 ^{5/8} "	cm 60x60 23 ^{3/8} "x23 ^{5/8} "	cm 60x60 23 ^{5/8} "x23 ^{5/8} "	cm 90x90 35 ^{3/8} "x35 ^{3/8} "	cm 90x90 35 ^{3/8} "x35 ^{3/8} "
Spessori Thicknesses Epaisseurs Stärken	mm 10 mm 9	mm 10	mm 20	mm 10	mm 20
Superfici Surfaces Surfaces Oberflächen	●	●	●	●	●

● Naturale ⁽¹⁾

DIN 51097 B	XP P 05-010 PN 18	
DIN 51130 R 10	XP P 05-010 PC 10	

● Grip ⁽²⁾

DIN 51097 C	XP P 05-010 PN 24	
DIN 51130 R 11	XP P 05-010 PC 20	

Rettificate in un unico calibro Rectified version in a single caliber Rectifiés en un unique calibre Boden Sie in einem einzigen Kaliber

⁽¹⁾ A pavimento: zone asciutte Floor: dry zones Revêtement de sol : zones sèches Boden: trokenzonen

⁽²⁾ A pavimento: zone asciutte e zone umide Floor: dry zones and wet zones Revêtement de sol : zones sèches et zones humides Boden: trokenzonen und feuchtzonen

Caratteristiche tecniche a pagina: Technical features on page: Caractéristiques techniques à la page: Technische Eigenschaften auf Seite: 207

MOSAICI*

Mosaico 6x6



30x30 cm 11^{3/4}"x11^{3/4}"
6x6 cm 2^{3/8}"x2^{3/8}"

su rete on net sur trame auf Netz

6 pc/box 1,53 kg/pc

PIETRA BAUGÉ - Naturale



* Vedi dettagli a pagina: See details on page: Voir détails à la page: Siehe Details auf Seite: 210

Mosaico 10x10



30x30 cm 11^{3/4}"x11^{3/4}"
10x10 cm 4"x4"

su rete on net sur trame auf Netz

6 pc/box 1,53 kg/pc

PIETRA BAUGÉ - Naturale



PEZZI SPECIALI PER PISCINE FITTINGS FOR SWIMMING POOLS PIÈCES SPÉCIALES POUR PISCINES FORMSTÜCKE FÜR SCHWIMMBÄDER

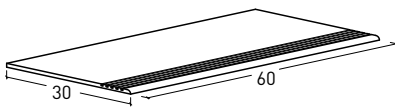

Gradino B.C 30x60 con righe

6 pc/box 3,89 kg/pc

PIETRA BAUGÉ - Naturale

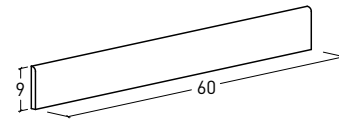

Battiscopa B.C. 9x60

18 pc/box 1,04 kg/pc

PIETRA BAUGÉ - Naturale

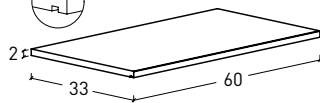

9550

3 pc/box 9,1 kg/pc

PIETRA BAUGÉ - Grip

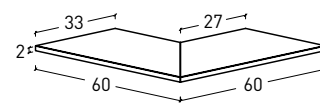

9557

2 pc 45° 1+1 pc/box 9,2 kg/pc

PIETRA BAUGÉ - Grip

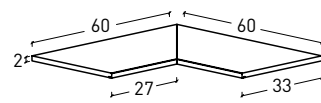

9558

2 pc 45° 1+1 pc/box 9,2 kg/pc

PIETRA BAUGÉ - Grip

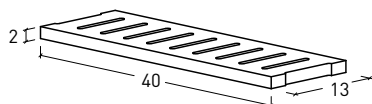

9885 ^{(1)}**

Padana-Deck 8 pc/box 2,0 kg/pc

PIETRA BAUGÉ - Grip

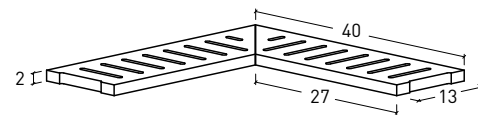

9886 ^{(1)}**

Padana-Deck 2 pc 45° 4+4 pc/box 3,5 kg/pc

PIETRA BAUGÉ - Grip



** Vedi pagina: See page: Voir page: Siehe Seite: 189

⁽¹⁾ Consigliata solo per piscine private. Consigliata solo per canalette di spiaggia Suggested for private pools only. Recommended for deck channels only.
Conseillée uniquement pour piscines privées. Conseillée uniquement pour caniveaux de plage Nur für private Schwimmbäder. Nur für Strandrinnen empfohlen

Stile

PIETRE NATIVE

Pale

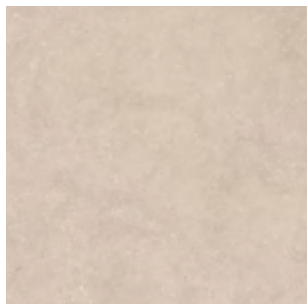

Beige

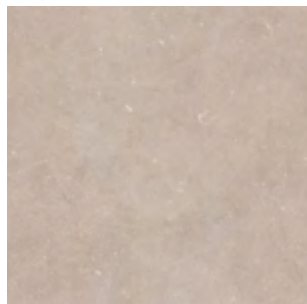

French Grey



White Smoke

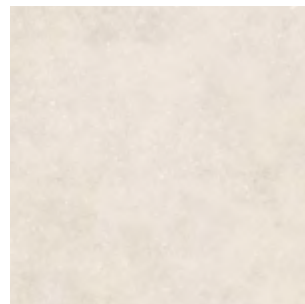

Pearl





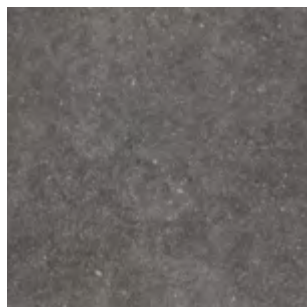

Black





Leggera
Minimal
Légère
Leichte

Vedi pagina: See page: Voir page: Siehe Seite: 209





					
Formati Sizes Formats Formate	cm 30x60 11 ^{3/4} "x23 ^{5/8} "	cm 60x60 23 ^{5/8} "x23 ^{5/8} "	cm 60x60 23 ^{5/8} "x23 ^{5/8} "	cm 60x120 23 ^{5/8} "x47 ^{1/4} "	cm 120x120 23 ^{5/8} "x23 ^{5/8} "
Spessori Thicknesses Epaisseurs Stärken	mm 9	mm 9	mm 20	mm 9	mm 9
Superfici Surfaces Surfaces Oberflächen	● ●	● ● ●	●	● ● ● ● ●	●

			
Formati Sizes Formats Formate	cm 45x90 17 ^{3/4} "x35 ^{3/8} "	cm 90x90 35 ^{3/8} "x35 ^{3/8} "	cm 90x90 35 ^{3/8} "x35 ^{3/8} "
Spessori Thicknesses Epaisseurs Stärken	mm 9	mm 9	mm 20
Superfici Surfaces Surfaces Oberflächen	●	● ●	●



● Naturale ⁽¹⁾

DIN 51130 R 10	XP P 05-010 PC 10	
-------------------	----------------------	---



● Grip ⁽²⁾

DIN 51097 A+B	XP P 05-010 PN 18	
DIN 51130 R 11	XP P 05-010 PC 20	

● Anticata ⁽¹⁾

DIN 51097 B	XP P 05-010 PN 18	
DIN 51130 R 10	XP P 05-010 PC 10	

● Diagonale ⁽¹⁾

DIN 51097 B	XP P 05-010 PN 18	
DIN 51130 R 10	XP P 05-010 PC 10	

● Rigata ⁽¹⁾

DIN 51097 B	XP P 05-010 PN 18	
DIN 51130 R 10	XP P 05-010 PC 10	

⁽¹⁾ A pavimento: zone asciutte Floor: dry zones Revêtement de sol : zones sèches Boden: trokenzonen

⁽²⁾ A pavimento: zone asciutte e zone umide Floor: dry zones and wet zones Revêtement de sol : zones sèches et zones humides Boden: trokenzonen und feuchtezonen

Caratteristiche tecniche a pagina: Technical features on page: Caractéristiques techniques à la page: Technische Eigenschaften auf Seite: **207**

STILE

MOSAICI*

Mosaico 5x5

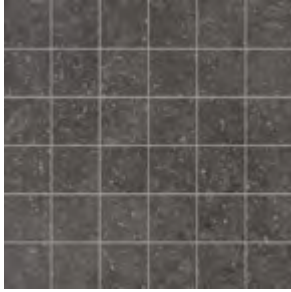

30x30 cm 11^{3/4}"x11^{3/4}"
5x5 cm 2"x2"

su rete on net sur trame auf Netz

6 pc/box 1,53 kg/pc

STILE - Naturale/Grip

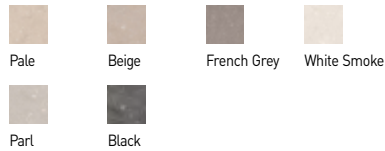

Mosaico 5x15

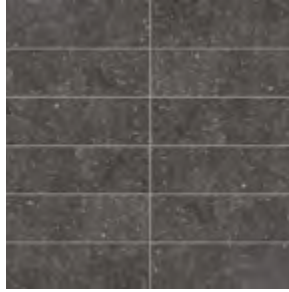

30x30 cm 11^{3/4}"x11^{3/4}"
5x15 cm 2"x5^{7/8}"

su rete on net sur trame auf Netz

6 pc/box 1,53 kg/pc

STILE - Naturale/Grip

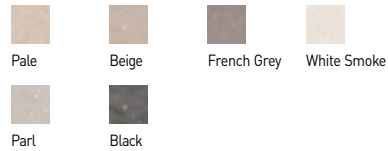

Composizione A



30x60 cm 11^{3/4}"x23^{5/8}"

6 pc/box 3,88 kg/pc

STILE - Naturale + Grip

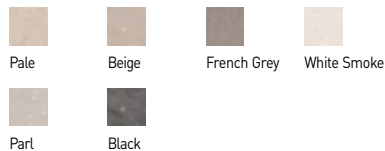

* Vedi dettagli a pagina: See details on page: Voir détails à la page: Siehe Details auf Seite: 210

decori e pezzi speciali / decors and fittings / décorations et pièces spéciales / dekore und formstücke

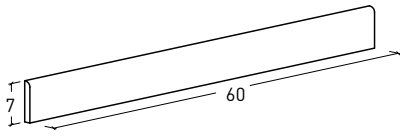

Battiscopa B.C. 7x60
18 pc/box 0,73 kg/pc

STILE - Naturale

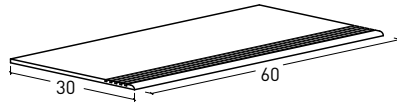
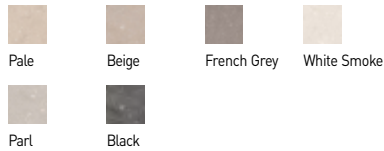

Gradino B.C 30x60 con righe
6 pc/box 3,89 kg/pc

STILE - Naturale

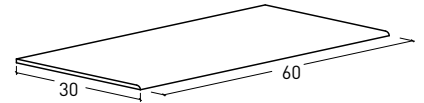
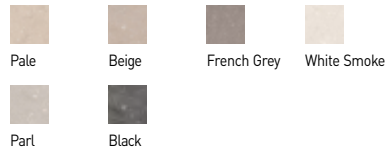

Gradino B.C 30x60 senza righe
6 pc/box 3,89 kg/pc

STILE - Grip

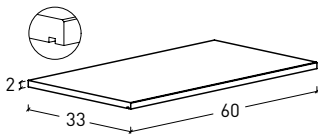
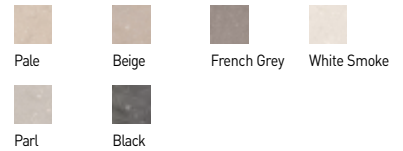

9550
3 pc/box 9,1 kg/pc

STILE - Grip

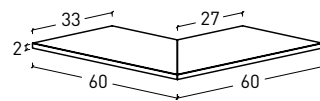
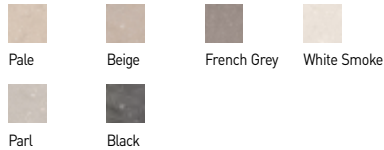

9557
2 pc 45° 1+1 pc/box 9,2 kg/pc

STILE - Grip

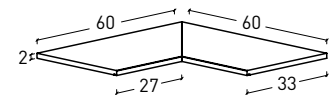
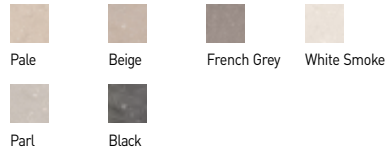

9558
2 pc 45° 1+1 pc/box 9,2 kg/pc

STILE - Grip

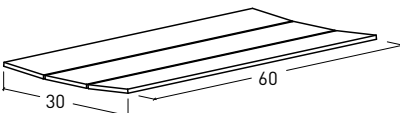
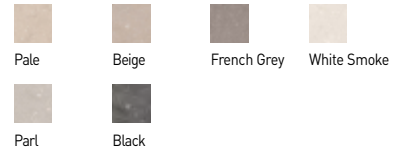

9795*
Padana-Deck 6 pc/box 10,0 kg/pc

STILE - Grip

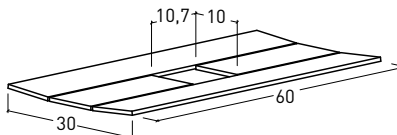
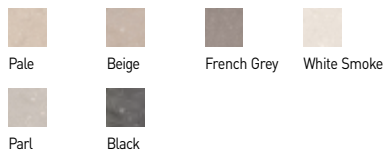

9796*
Padana-Deck 6 pc/box 9,8 kg/pc

STILE - Grip

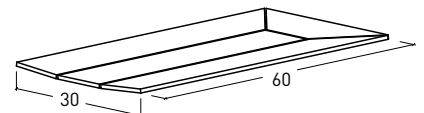
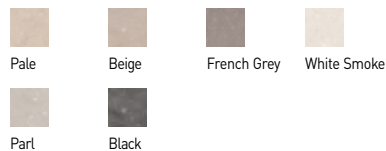

9797*
Padana-Deck 6 pc/box 9,8 kg/pc

STILE - Grip

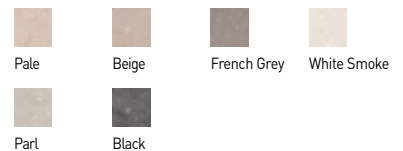

* Fornito assemblato su rete, da posizionarsi/inclinarsi in opera. Assemblaggio ad inclinazione flessibile fino a max 10% Supplied on mesh to be positioned/adapted on site. Assembly with flexible slope up to max 10% Fourni assemble sur trame, a positionner/incliner sur chantier. Assemblage flexible avec pentes jusqu'à 10% Wird auf Netz montiert geliefert, auf der Baustelle zu positionieren neigen. Flexibel Montage mit Neigungen bis max 10%

Vedi pagina: See page: Voir page: Siehe Seite: 185

Timeless

GRANITOGRES

Charcoal



Thunder



Seal

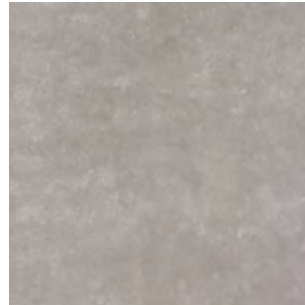

Ice



Taupe

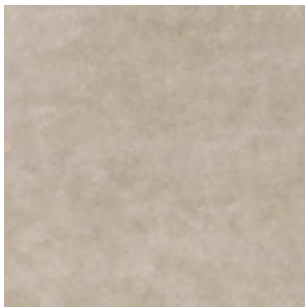

Leggera
Minimal
Légère
Leichte

Vedi pagina: See page: Voir page: Siehe Seite: 209

Formati Sizes Formats Formate	cm 30x60 11 ^{3/4} "x23 ^{3/8} "	cm 60x60 23 ^{5/8} "x23 ^{5/8} "	cm 60x60** 23 ^{5/8} "x23 ^{5/8} "	cm 60x120 23 ^{5/8} "x47 ^{1/4} "
Spessori Thicknesses* Epaisseurs Stärken	mm 9,4	mm 9,4	mm 14	mm 9,4
Superfici Surfaces Surfaces Oberflächen	● ●	● ●	●	● ●

● Naturale ⁽¹⁾

● Bocciardata ⁽²⁾

DIN 51097 A+B	XP P 05-010 PN 18	
DIN 51130 R 11	XP P 05-010 PC 20	

Rettificata in un unico calibro Rectified version in a single caliber Rectifiés en un unique calibre Boden Sie in einem einzigen Kaliber

* Spessore su superficie naturale Thickness on matt surface Epaisseur sur surface mat Stärck der Fliesen mit Matt Oberfläche

** Disponibile nei colori: Available in the colours: Disponible dans les couleurs: Verfügbar in den folgenden Farben: **Ice, Taupe, Thunder**
Altri colori sono prodotti solo su richiesta Other colours are produced on demand Autres teintes disponibles sur demand Andere Farben nur auf Antrag

⁽¹⁾ A pavimento: zone asciutte Floor: dry zones Revêtement de sol : zones sèches Boden: trokenzonen

⁽²⁾ A pavimento: zone asciutte e zone umide Floor: dry zones and wet zones Revêtement de sol : zones sèches et zones humides Boden: trokenzonen und feuchtzonen

Caratteristiche tecniche a pagina: Technical features on page: Caractéristiques techniques à la page: Technische Eigenschaften auf Seite: 204

colori / colours / couleurs / farben
decori e pezzi speciali / decors and fittings / décorations et pièces spéciales / dekore und formstücke

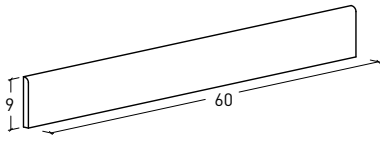

Battiscopa B.C. 9x60
 18 pc/box 1,04 kg/pc

TIMELESS - Naturale

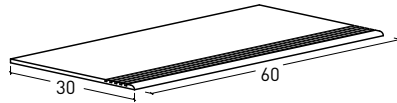

Gradino B.C 30x60 con righe
 6 pc/box 3,89 kg/pc

TIMELESS - Naturale

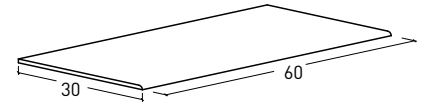
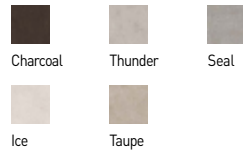

Gradino B.C 30x60 senza righe
 6 pc/box 3,89 kg/pc

TIMELESS - Bocciardata

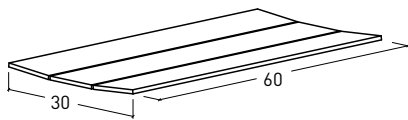
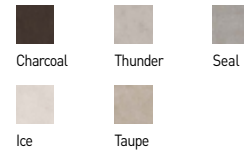

9795*
 Padana-Deck 6 pc/box 10,0 kg/pc

TIMELESS - Bocciardata

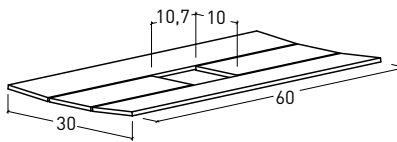
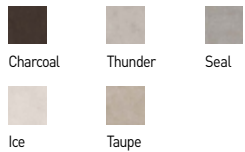

9796*
 Padana-Deck 6 pc/box 9,8 kg/pc

TIMELESS - Bocciardata

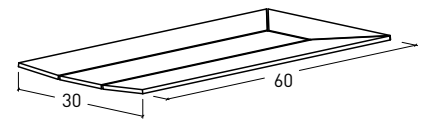
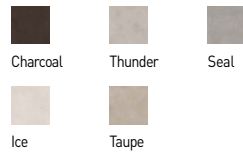

9797*
 Padana-Deck 6 pc/box 9,8 kg/pc

TIMELESS - Bocciardata

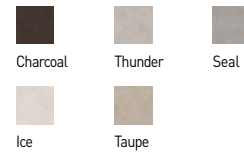

* Fornito assemblato su rete, da posizionarsi/inclinarsi in opera. Assemblaggio ad inclinazione flessibile fino a max 10% Supplied on mesh to be positioned/adapted on site.
 Assembly with flexible slope up to max 10% Fourni assemble sur trame, a positionner/incliner sur chantier. Assemblage flexible avec pentes jusqu'à 10% Wird auf Netz montiert geliefert, auf der Baustelle zu positionieren neigen. Flexibel Montage mit Neigungen bis max 10%

Vedi pagina: See page: Voir page: Siehe Seite: 185



Petra

PIETRE NATIVE

Petra Oro

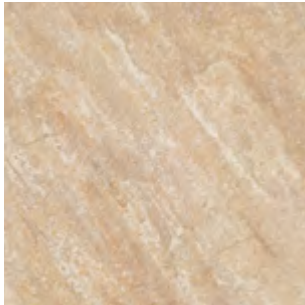

Petra Grigia

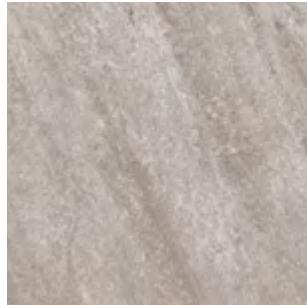

Petra Antracite



Petra Perla

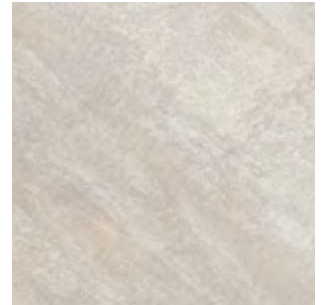

Petra Bianca





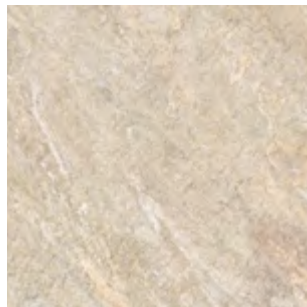



Petra Sabbia



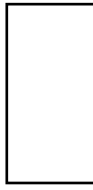

Accentuata
Accentuated
Importante
Starke

Vedi pagina: See page: Voir page: Siehe Seite: 209

				
Formati Sizes Formats Formate	cm 8,2x25* 3 1/4" x 9 7/8"	cm 20x20* 7 7/8" x 7 7/8"	cm 20x40* 7 7/8" x 15 3/4"	cm 30x60 11 3/4" x 23 5/8"
Spessori Thicknesses Epaisseurs Stärken	mm 9	mm 8	mm 8	mm 9
Superfici Surfaces Surfaces Oberflächen	●	●	●	● ●
				
Formati Sizes Formats Formate	cm 60x60 23 5/8" x 23 5/8"	cm 60x60** 23 5/8" x 23 5/8"	cm 60x120 23 5/8" x 47 1/4"	cm 60x120** 23 5/8" x 47 1/4"
Spessori Thicknesses Epaisseurs Stärken	mm 9	mm 20	mm 9	mm 20*
Superfici Surfaces Surfaces Oberflächen	● ●	●	● ●	●

● Naturale ⁽¹⁾

● Grip ⁽²⁾

DIN 51097 B	XP P 05-010 PN 18	
DIN 51130 R 10	XP P 05-010 PC 10	

DIN 51097 B	XP P 05-010 PN 18	
DIN 51130 R 11	XP P 05-010 PC 20	

* Non rettificato Not rectified Non rectifié Nicht rektifizierle

** Disponibile nei colori: Available in the colours: Disponible dans les couleurs: Verfügbar in den folgenden Farben: **Petra Grigia, Petra Perla, Petra Sabbia**

⁽¹⁾ A pavimento: zone asciutte Floor: dry zones Revêtement de sol : zones sèches Boden: trokenzonen

⁽²⁾ A pavimento: zone asciutte e zone umide Floor: dry zones and wet zones Revêtement de sol : zones sèches et zones humides Boden: trokenzonen und feuchtezonen

Caratteristiche tecniche a pagina: Technical features on page: Caractéristiques techniques à la page: Technische Eigenschaften auf Seite: 207



PETRA

MOSAICI*

Mosaico 5x5



30x30 cm 11³/₄"x11³/₄"
5x5 cm 2"x2"

Standard **su rete** Standard on net
Standard sur trame Standard auf Netz

Su richiesta con rete davanti
On demand with net on front side
Sur demande avec trame sulla belle face
Auf Anfrage mit Netz auf Vorderseite

6 pc/box 1,53 kg/pc

PETRA - Naturale / Grip



Petra Oro Petra Grigia Petra Antracite Petra Perla



Petra Bianca Petra Sabbia

Mosaico 5x15



30x30 cm 11³/₄"x11³/₄"
5x15 cm 2"x5⁷/₈"

Standard **su rete** Standard on net
Standard sur trame Standard auf Netz

6 pc/box 1,53 kg/pc

PETRA



Petra Oro Petra Grigia Petra Antracite Petra Perla



Petra Bianca Petra Sabbia

Composizione A



30x60 cm 11³/₄"x23⁵/₈"

su rete on net sur trame auf Netz

6 pc/box 3,88 kg/pc

PETRA



Petra Oro Petra Grigia Petra Antracite Petra Perla



Petra Bianca Petra Sabbia

* Vedi dettagli a pagina: See details on page: Voir détails à la page: Siehe Details auf Seite: **210**

decori / decors / décorations / dekore
pezzi speciali / fittings / pièces spéciales / formstücke

PEZZI SPECIALI PER PISCINE FITTINGS FOR SWIMMING POOLS PIÈCES SPÉCIALES POUR PISCINES FORMSTÜCKE FÜR SCHWIMMBÄDER

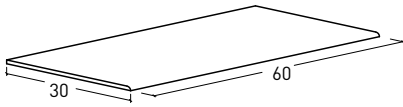

Gradino B.C 30x60 senza righe
6 pc/box 3,89 kg/pc

PETRA - Naturale / Grip

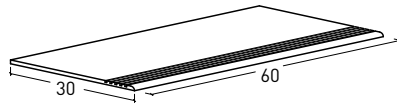
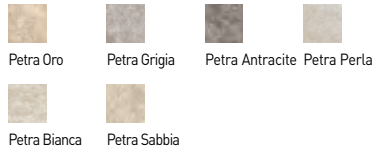

Gradino B.C 30x60 con righe
6 pc/box 3,89 kg/pc

PETRA - Naturale

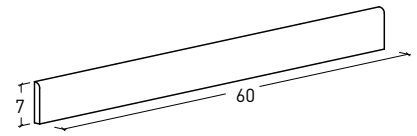
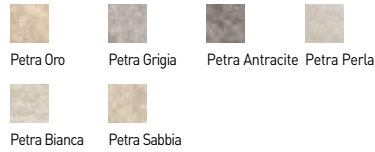

Battiscopa B.C. 7x60
18 pc/box 1,04 kg/pc

PETRA - Naturale

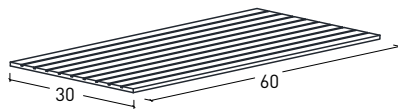
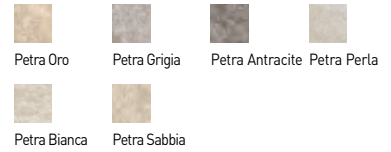

9810
6 pc/box 89 kg/pc

PETRA - Grip

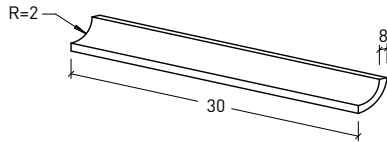
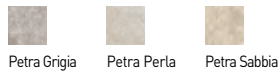

9830
48 pc/box 0,2 kg/pc

PETRA - Naturale

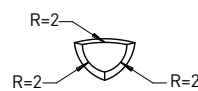
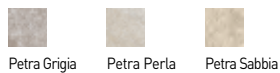

9833
10 pc/box 0,05 kg/pc

PETRA - Naturale

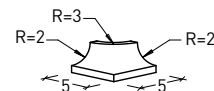

9834
10 pc/box 0,05 kg/pc

PETRA - Naturale

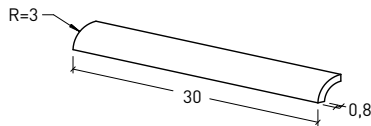

9835
48 pc/box 0,2 kg/pc

PETRA - Grip

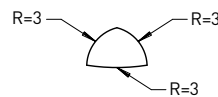
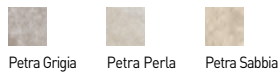

9837
10 pc/box 0,05 kg/pc

PETRA - Grip

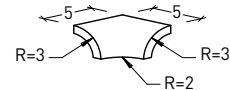

9838
10 pc/box 0,05 kg/pc

PETRA



PETRA

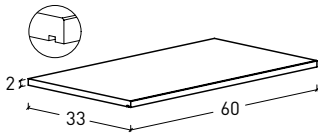

9550

3 pc/box 9,1 kg/pc

PETRA - Grip

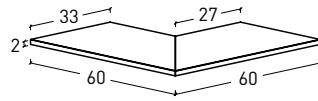
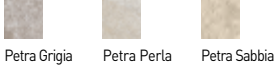

9557

2 pc 45° 1+1 pc/box 9,2 kg/pc

PETRA - Grip

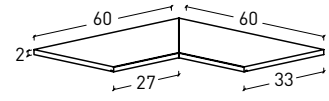
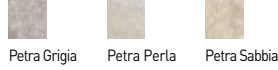

9558

2 pc 45° 1+1 pc/box 9,2 kg/pc

PETRA - Grip

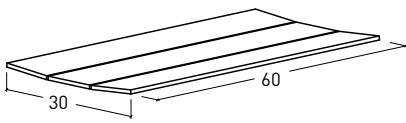
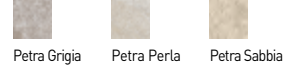

9795*

Padana-Deck 6 pc/box 10,0 kg/pc

PETRA - Grip

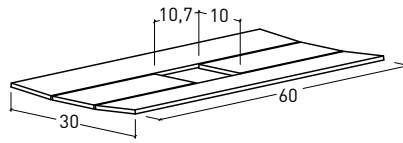
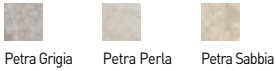

9796*

Padana-Deck 6 pc/box 9,8 kg/pc

PETRA - Grip

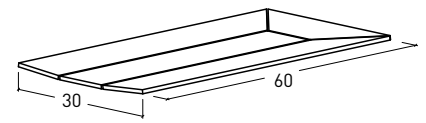
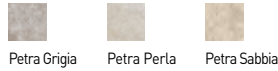

9797*

Padana-Deck 6 pc/box 9,8 kg/pc

PETRA - Grip

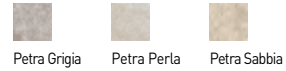

Vedi pagina: See page: Voir page: Siehe Seite: 185

* Forni assemblato su rete, da posizionarsi/inclinarsi in opera. Assemblaggio ad inclinazione flessibile fino a max 10% Supplied on mesh to be positioned/adapted on site.
 Assembly with flexible slope up to max 10% Fourni assemble sur trame, a positionner/incliner sur chantier. Assemblage flexible avec pentes jusqu'à 10% Wird auf Netz
 montiert geliefert, auf der Baustelle zu positionieren neigen. Flexibel Montage mit Neigungen bis max 10%



Eco Concrete

GRESPLUS

Eco Bianco

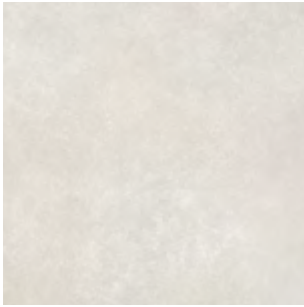

Eco Beige



Eco Cenere



Eco Grigio

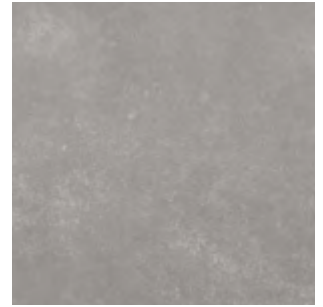

Eco Antracite



Media
Medium
Modérée
Mittlere

Vedi pagina: See page: Voir page: Siehe Seite: **209**

Formati Sizes Formats Formate	cm 30x60 11 ³ / ₄ " x 23 ⁵ / ₈ "	cm 60x60 23 ⁵ / ₈ " x 23 ⁵ / ₈ "	cm 60x120 23 ⁵ / ₈ " x 47 ¹ / ₄ "
Spessori Thicknesses Epaisseurs Stärken	mm 8	mm 9	mm 9
Superfici Surfaces Surfaces Oberflächen	● ●	● ●	●

● Naturale ⁽¹⁾

DIN 51097 B	XP P 05-010 PN 18	
DIN 51130 R 10	XP P 05-010 PC 10	

● Grip ⁽²⁾

DIN 51097 B	XP P 05-010 PN 18	
DIN 51130 R 11	XP P 05-010 PC 20	

Rettificate in un unico calibro Rectified version in a single caliber Rectifiés en un unique calibre Boden Sie in einem einzigen Kaliber

⁽¹⁾ A pavimento: zone asciutte Floor: dry zones Revêtement de sol : zones sèches Boden: trokenzonen

⁽²⁾ A pavimento: zone asciutte e zone umide Floor: dry zones and wet zones Revêtement de sol : zones sèches et zones humides Boden: trokenzonen und feuchtnzonen

Caratteristiche tecniche a pagina: Technical features on page: Caractéristiques techniques à la page: Technische Eigenschaften auf Seite: **206**

MOSAICI*

Mosaico 6x6



30x30 cm 11^{3/4}"x11^{3/4}"
6x6 cm 2^{3/8}"x2^{3/8}"

su rete on net sur trame auf Netz

6 pc/box 1,53 kg/pc

ECO CONCRETE - Naturale / Grip



Eco Bianco Eco Beige Eco Cenere Eco Grigio Eco Antracite

PEZZI SPECIALI PER PISCINE FITTINGS FOR SWIMMING POOLS PIÈCES SPÉCIALES POUR PISCINES FORMSTÜCKE FÜR SCHWIMMBÄDER

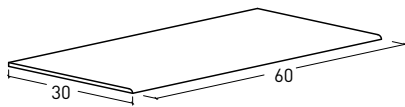

Gradino B.C 30x60 senza righe

6 pc/box 3,89 kg/pc

ECO CONCRETE - Naturale



Eco Bianco Eco Beige Eco Cenere Eco Grigio Eco Antracite

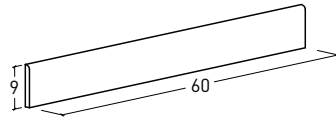

Battiscopa B.C. 9x60

18 pc/box 1,04 kg/pc

ECO CONCRETE - Naturale



Eco Bianco Eco Beige Eco Cenere Eco Grigio Eco Antracite

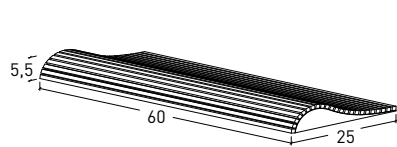

9660 - Pool Wave

1 pc/box 10,0 kg/pc

ECO CONCRETE - Grip



Eco Bianco Eco Beige Eco Cenere Eco Grigio Eco Antracite

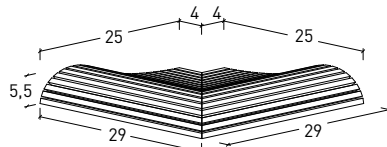

9667 - Pool Wave

2 pc 45° 1+1 pc/box 9,8 kg/pc

ECO CONCRETE - Grip



Eco Bianco Eco Beige Eco Cenere Eco Grigio Eco Antracite

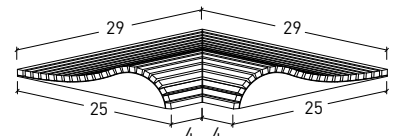

9668 - Pool Wave

2 pc 45° 1+1 pc/box 9,8 kg/pc

ECO CONCRETE - Grip



Eco Bianco Eco Beige Eco Cenere Eco Grigio Eco Antracite

* Vedi dettagli a pagina: See details on page: Voir détails à la page: Siehe Details auf Seite: 210

Padana Deck_Wellness&Spa canalette per esterni vasca

CHANNELS FOR POOL DECKS
CANIVEAUX DE PLAGE
BECKENUMGANGSRINNEN

Anche nel caso delle collezioni Casalgrande Padana sono disponibili un insieme di pezzi speciali e sistemi dedicati al recupero dell'acqua, sia con sistemi puntuali, sia creando canalizzazioni complete con e senza griglie di copertura.

Even for the collections Casalgrande Padana, a line of fittings and systems designed specifically to collect water on pool deck can be used to recover water through a system of channels with or without covering grating.

Même pour les collections Casalgrande Padana, une ligne de pièces spéciales et systèmes spécifiques permet de récupérer l'eau moyennant un système de caniveaux sans ou avec grille de recouvrement.

Auch im Fall der Casalgrande Padana Kollektionen gibt es eine Reihe von speziellen Stücken und Systemen für die Wasserrückgewinnung, sowohl mittels punktueller Systemen als auch anhand der Verlegung kompletter Kanalisierungen mit und ohne Abdeckroste.



Mod.CP 007

CANALETTA PIANA E SCARICO A QUATTRO PENDENZE ANTISCIVOLO NON-SLIP FLAT CHANNEL AND INDEPENDENT WATER OUTLET
 CANIVEAU PLAT ET CUNETTE DE'ECOLEMENT ANTIDERAPANTS NON-SLIP FLACHRINNE UND FREIES WASSERABLAUF

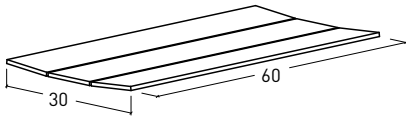

9795*

Padana-Deck 6 pc/box 10,0 kg/pc

MINERAL CHROM - Naturale

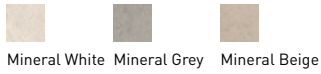

AMAZZONIA - Grip



MARTE - Bocciardata

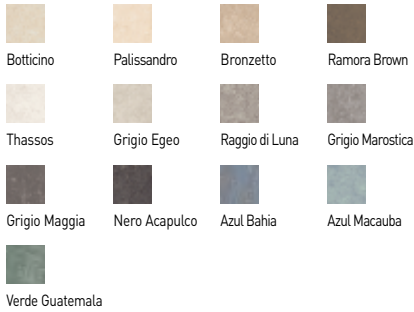

STILE - Grip

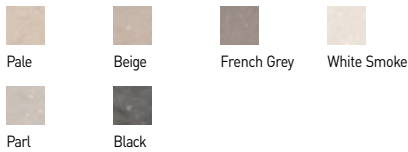

TIMELESS - Bocciardata



PETRA - Grip

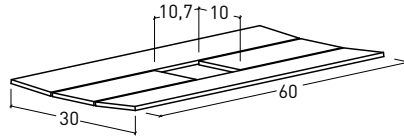
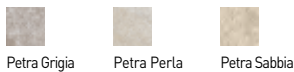

9796*

Padana-Deck 6 pc/box 9,8 kg/pc

MINERAL CHROM - Naturale



AMAZZONIA - Grip



MARTE - Bocciardata

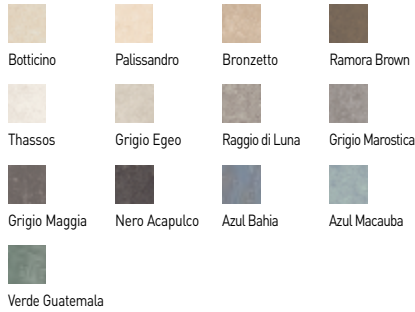

STILE - Grip

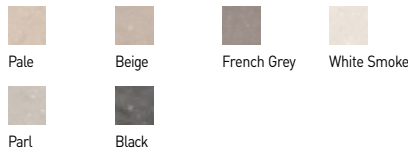

TIMELESS - Bocciardata



PETRA - Grip

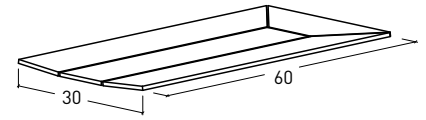

9797*

Padana-Deck 6 pc/box 9,8 kg/pc

MINERAL CHROM - Naturale

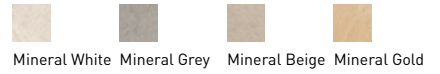

AMAZZONIA - Grip

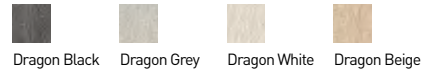

MARTE - Bocciardata

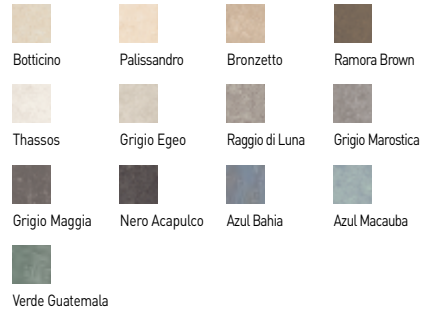

STILE - Grip

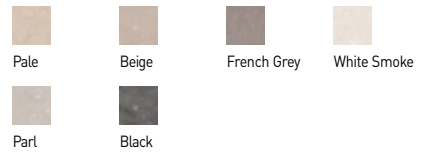

TIMELESS - Bocciardata



PETRA - Grip

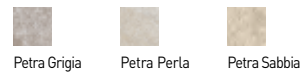

* Fornito assemblato su rete, da posizionarsi/inclinarsi in opera. Assemblaggio ad inclinazione flessibile fino a max 10% Supplied on mesh to be positioned/adapted on site. Assembly with flexible slope up to max 10%
 Fourni assemble sur trame, a positionner/incliner sur chantier. Assemblage flexible avec pentes jusqu'à 10% Wird auf Netz montiert geliefert, auf der Baustelle zu positionieren neigen. Flexibel Montage mit Neigungen bis max 10%

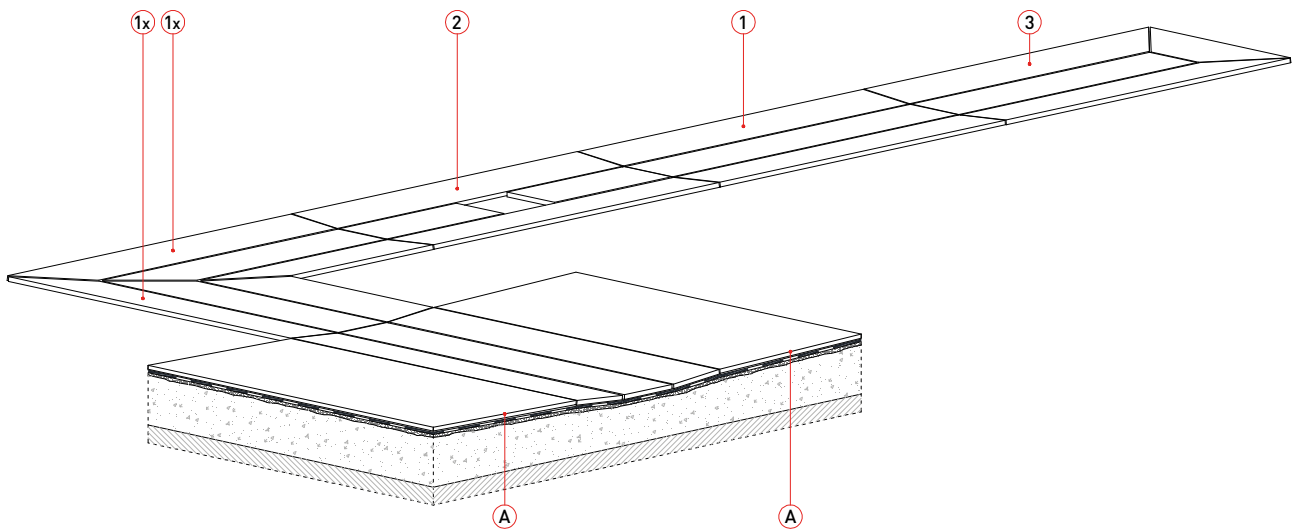

A piastrella spiaggia pool deck tile carreau de plage beckenumgang-fliese

x= Tagliato in cantiere To be cut on the job site À couper en chantier Auf der baustelle geschnitten

Per le bocchette di scarico da applicare a questo sistema vedi pag. 191
 For the water outlets suitable to this system see pages 191
 Pour les siphons de ce système voir pages 191
 Für die Wasserabläufe dieses Systems siehe Seiten 191



Mod. CP003 - GK03

CANALETTE CON GRIGLIE DI COPERTURA CHANNELS WITH GRATINGS CANIVEAUX AVEC GRILLES RINNEN MIT ABDECKROSTE

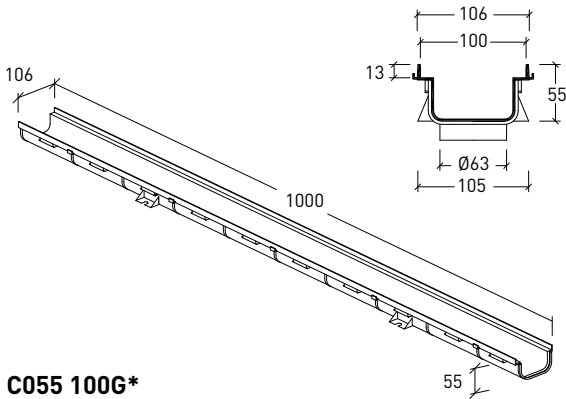

C055 100G*

Padana-Grid 12 pc/box 0,9 kg/pc

Canaletta in PVC con scarico verticale Ø 40 mm o Ø 63 mm **
 PVC channel with vertical outlet Ø 40 mm or Ø 63 mm
 Caniveau en PVC avec évacuation verticale Ø 40 mm ou Ø 63 mm
 PVC Rinne mit vertikalem Wasserablauf Ø 40 mm oder Ø 63 mm

* Conservare al riparo dalla luce solare ed a temperature < 40°C
 Keep away from sunlight and store at temperatures <40°C
 Conserver à l'abri du rayonnement solaire et à des températures <40 °C
 Vor Sonnenlicht geschützt und bei Temperaturen <40°C lagern

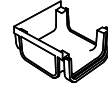

A055 100G*

Padana-Grid 10 pc/box 0,12 kg/pc

Angolo/incrocio a 3 o 4 vie in PVC con scarico verticale Ø 40 mm o Ø 80 mm **
 PVC corner/ T or X junction with vertical outlet Ø 40 mm o Ø 80 mm
 Angle/jonction en T ou en X en PVC avec évacuation verticale Ø 40 mm o Ø 80 mm
 PVC Ecke T oder X förmige Kreuzung Ø 40 mm o Ø 80 mm



T055 100G*

Padana-Grid 25 pc/box 0,05 kg/pc

Testata in PVC con scarico orizzontale Ø 50 mm **
 PVC stop-end with horizontal outlet Ø 50 mm
 About en PVC avec évacuation horizontale Ø 50 mm
 Endstück aus PVC mit horizontalem Wasserablauf Ø 50 mm

** Scarico da forare in cantiere (solo se necessario)
 Outlet to be drilled on the job site (only when necessary)
 Evacuation a percer en chantier (uniquement si nécessaire)
 Wasserablauf auf der Baustelle zu schneiden (erforderlichenfalls)

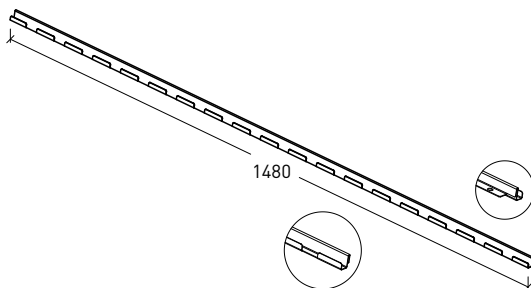

GK03 4A15***

Padana-Grid 1 pc/box 0,55 kg/pc

Profilo laterale inox per canaletta Pvc
 Stainless steel lateral profile for Pvc channel
 Profil latéral inox pour caniveau en Pvc
 Seitenprofil aus Edelstahl für Rinne aus Pvc

*** Articoli realizzati con acciaio inox AISI 316L-BA - EN 1.4404 (Lucido) / Classe di corrosività C4
 Items made with stainless steel AISI 316L-BA - EN 1.4404 (Polished) / Corrosion Class C4
 Références fabriquées en acier inox AISI 316L-BA - EN 1.4404 (Poli) / Catégorie de corrosivité C4
 Artikel aus Edelstahl AISI 316L-BA - EN 1.4404 (Glanzend) / Korrosionsklasse C4

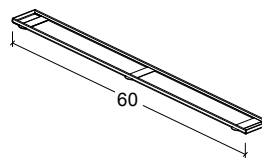

GK03 4B60***

Padana-Grid 1 pc/box 0,9 kg/pc

Vaschetta portapiastrelle inox
 Stainless steel tray for ceramic tiles
 Bac inox pour carreaux
 Fliesenträger aus Edelstahl

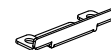

GK03-4CPP ***

Padana-Grid 1 pc/box 1,4 kg/pc

Testata per vaschetta inox
 Step end for stainless steel tray
 About pour bac inox
 Endstück für Fliesenträger aus Edelstahl

Mod.CP 003 - GK03

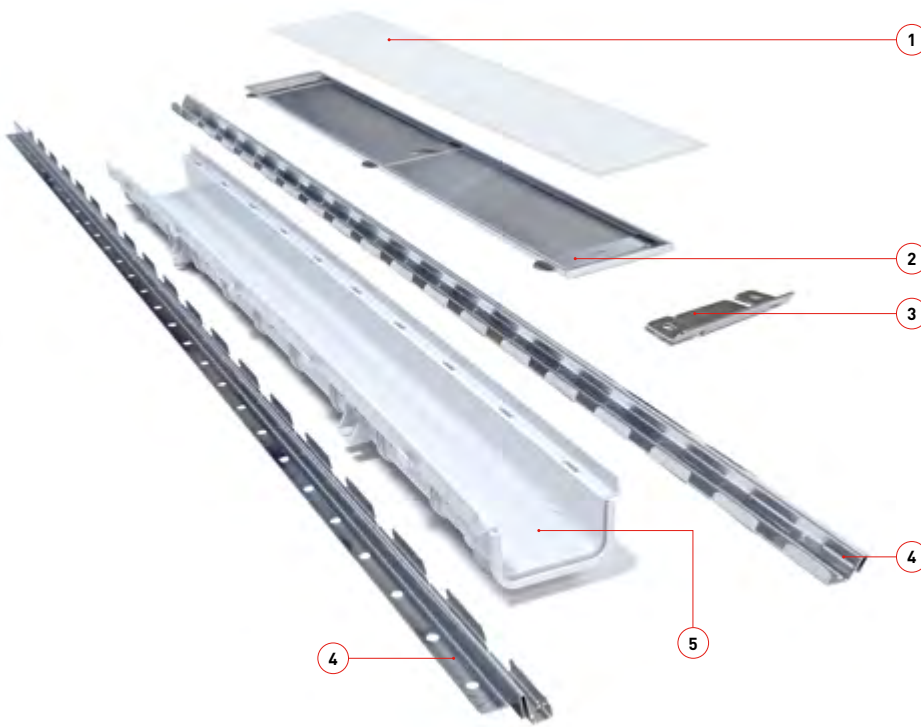

- 1 Piastrella (da tagliare in cantiere)
Ceramic tile (to be cut on job site)
Carreau céramique (à découper en chantier)
Fliese (auf der Baustelle zu schneiden)
- 2 GK03-4B60
- 3 GK03-4CPP
- 4 GK03-4A15
- 5 C055-100G

MINERAL CHROM - Naturale



AMAZZONIA - Grip



MARTE - Bocciaidata



PIETRE DI SARDEGNA - Grip



PETRA - Grip

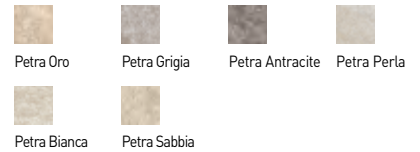

STILE - Grip

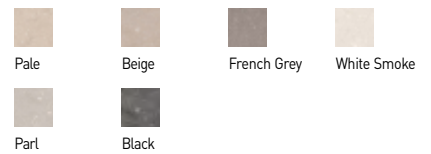

TIMELESS - Bocciaidata



* Superficie Grip A+B solo su richiesta
Surface Grip A+B on request only
Surface Grip A+B uniquement sur demande
Oberfläche Grip A+B nur auf Anfrage

Mod.CP 006

CANALETTE CON GRIGLIE DI COPERTURA CHANNELS WITH GRATINGS CANIVEAUX AVEC GRILLES RINNEN MIT ABDECKROSTE

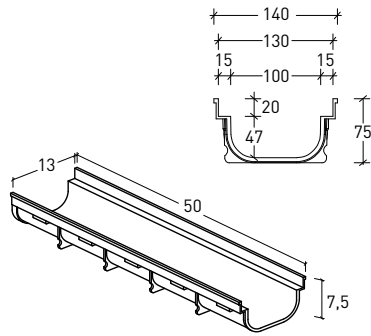

A075 130G*

Padana-Grid 10 pc/box 0,2 kg/pc

Angolo e giunto a 4 vie con scarico verticale Ø 90 mm o Ø 110 mm**
 Corner en X junction with vertical outlet Ø 90 mm or Ø 110 mm**
 Angle et jonction en X avec évacuation verticale Ø 90 mm ou Ø 110 mm**
 Ecke und X förmige Kreuzung mit vertikalem Wasserablauf Ø 90 mm oder Ø 110 mm**



T075 130G*

Padana-Grid 25 pc/box 0,05 kg/pc

Testata con scarico con scarico orizzontale Ø 40 mm**
 Stop end with outlet with horizontal outlet Ø 40 mm**
 About avec évacuation avec évacuation horizontale Ø 40 mm**
 Endstück mit Ablauf mit horizontalem Wasserablauf Ø 40 mm**

C075 130G*

Padana-Grid 12 pc/box 0,6 kg/pc

Canaletta in PVC senza scarico
 PVC channel without outlet
 Caniveau en PVC sans évacuation
 PVC Rinne ohne Wasserablauf

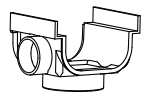

S075 130G*

Padana-Grid 25 pc/box 0,2 kg/pc

Giunto con doppio scarico laterale Ø 50 mm e scarico verticale Ø 80 mm**
 Insert with double lateral outlets Ø 50 mm and vertical outlet Ø 80 mm**
 Jonction avec double évacuation latéral Ø 50 mm et évacuation verticale Ø 80 mm**
 Stück mit doppel seitlichen Ablauf Ø 50 mm und vertikalem Wasserablauf Ø 80 mm**

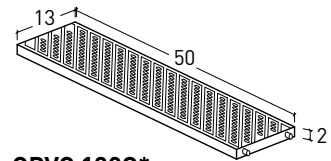

GPVC 130G*

Padana-Grid 1 pc/box 0,55 kg/pc

Griglia in Pvc
 Pvc grating
 Grille en Pvc
 Rost aus Pvc

* Conservare al riparo dalla luce solare ed a temperature < 40°C Keep away from sunlight and store at temperatures <40°C Conserver à l'abri du rayonnement solaire et à des températures <40 °C
 Vor Sonnenlicht geschützt und bei Temperaturen <40°C lagern

** Scarico da forare in cantiere (solo se necessario) Outlet to be drilled on the job site (only when necessary) Évacuation à percer en chantier (uniquement si nécessaire)
 Wasserablauf auf der Baustelle zu schneiden (erforderlichenfalls)

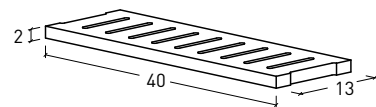

9885 (1)

Padana-Deck 8 pc/box 2,0 kg/pc

AMAZZONIA - Grip



COUNTRY WOOD - Grip



PIETRE DI SARDEGNA - Grip



PIETRA BAUGÉ - Grip

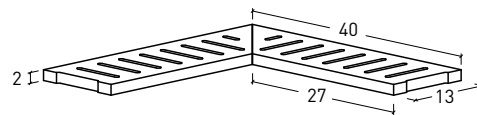

9886 (1)

Padana-Deck 2 pc 45° 4+4 pc/box 3,5 kg/pc

AMAZZONIA - Grip

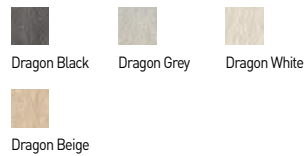

COUNTRY WOOD - Grip

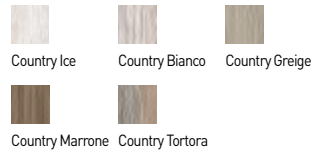

PIETRE DI SARDEGNA - Grip



PIETRA BAUGÉ - Grip



(1) Consigliata solo per piscine private. Consigliata solo per canalette di spiaggia Suggested for private pools only. Recommended for deck channels only
 Conseillée uniquement pour piscines privées. Conseillée uniquement pour caniveaux de plage Nur für private Schwimmbäder. Nur für Strandrinnen empfohlen

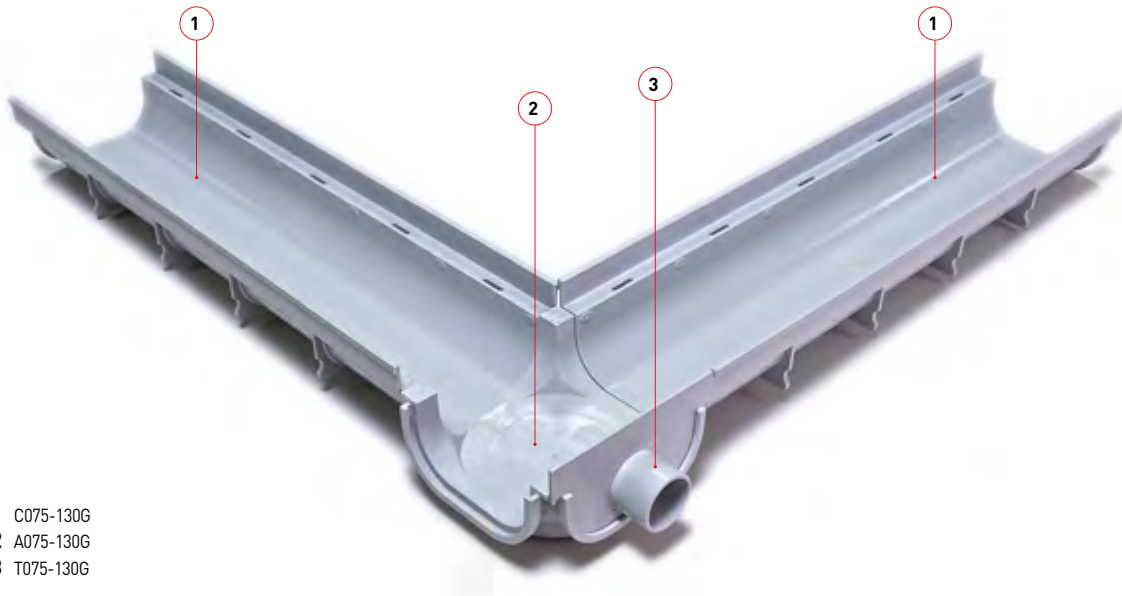

- 1 C075-130G
- 2 A075-130G
- 3 T075-130G

Mod.CP 006 - PVC

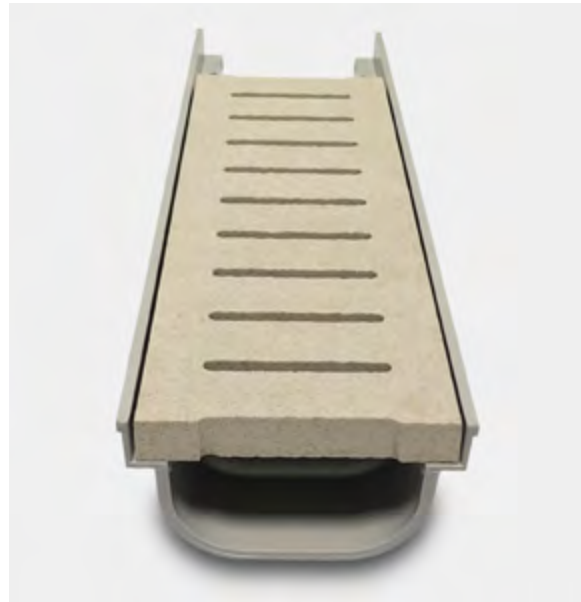

**BOCCHETTE DI SCARICO IMPERMEABILIZZATE PER CANALLETTE DI ESTERNO VASCA WATERPROOFING WATER OUTLETS FOR DECK CHANNELS
EVACUATIONS ETANCHES POUR CANIVEAUX DE PLAGE ABGEDICHTETE WASSERABLÄUFE FÜR BECKENUMGANGSRINNEN**

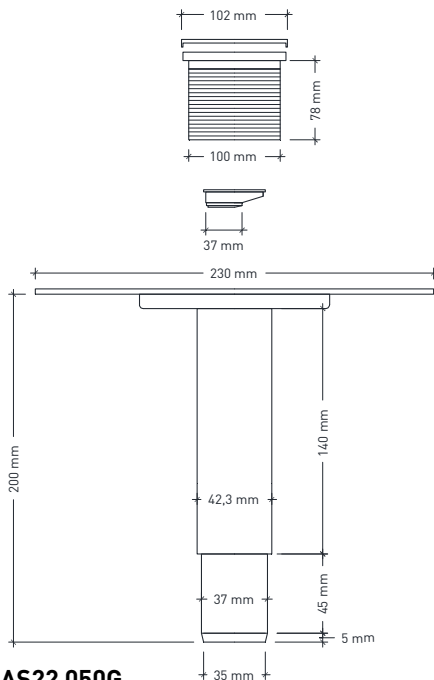
**AS22 050G**

Padana-Deck

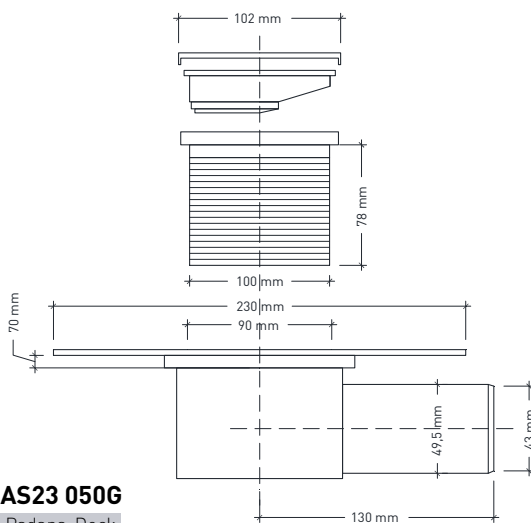
**AS23 050G**

Padana-Deck



Le bocchette di scarico AS22 050G (scarico verticale) e AS23 050G (scarico orizzontale) sono capaci di assicurare la continuità con l'impermeabilizzazione del pavimento circostante grazie al processo di termo fusione che unisce il telo impermeabile con la flangia della bocchetta. Entrambi i modelli sono dotati di scarico con diametro di 35 mm, della prolunga intagliabile per la gestione degli spessori, del tappo antiodore e della elegante griglia in acciaio inox AISI 304 100x100 mm.

The water outlets AS22 050G (vertical) and AS23 050G (horizontal) are able to ensure continuity of waterproofing on pool decks thanks to the waterproofing membrane duly connected with lower part of the outlets. Both models have are equipped with 35 mm drain pipe, with an adjustable extension to manage different thicknesses of concrete, with anti-odour -cap and with an elegant stainless steel grid AISI 304 100x100 mm.

Les siphons AS22 050G (vertical) et AS23 050G (horizontal), garantissent la continuité de l'étanchéité de la plage grâce à la membrane soudé à la partie inférieure des siphons. Les deux modèles sont équipés d'une sortie de 35 mm, d'un rallonge à couper par rapport à l'épaisseur de la chape, d'un coupe-odeurs et d'une élégante grille en acier inox AISI 304 100x100 mm.

Die Wasserabläufe AS22 050G (vertikal) und AS23 050G (horizontal) gewährleisten die Kontinuität mit der Abdichtung des umliegenden Bodens und dies der wasserdichten Membran dankend. Beide Typen sind ausgestattet mit Düse zu 35 mm Durchmesser, einstellbarer Verlängerung um unterschiedlichen Höhen zu regeln, Geruchskappe und eleganter Gitter aus Edelstahl AISI 304 100x100 mm.

Prodotti complementari

COMPLEMENTARY PRODUCTS
PRODUITS COMPLEMENTAIRES
ERGÄNZUNGSPRODUKTE

Nell'ampia gamma di Casalgrande Padana si possono individuare diversi prodotti adatti ai pavimenti e rivestimenti degli spazi pertinenti alla piscina come spogliatoi, docce, solarium o altre zone.

La selezione dei rivestimenti murali riguarda diverse collezioni e formati per offrire varianti di colore al programma specifico per piscine.

Per i pavimenti sono illustrati i prodotti della gamma Technic con valori antiscivolo a piedi nudi di Gruppo B (minimo necessario per le aree prevalentemente bagnate) e di Gruppo C (necessario per le aree prevalentemente immerse nell'acqua) misurati secondo la norma tedesca DIN 51097.

In questa sezione sono indicate soltanto le superfici che rientrano nei valori di antiscivolo sopra citati ed i minimali dei colori disponibili.

Per gli altri pavimenti che non devono avere un particolare valore antiscivolo si rimanda alla vasta gamma del catalogo generale di Casalgrande Padana.

Casalgrande Padana has a wide range of floor and wall products suitable to complementary swimming pool areas such as changing rooms, showers, tanning stations or other nonslip areas.

The range of wall claddings rests on several collections and sizes to offer additional colors options to the specific swimming pool range.

For floorings, this section includes the Technic range and only references rated group B (necessary for generally wet areas) and group C (normally submerged surfaces) barefoot, in accordance with German standard DIN 51097.

Here are reported only the surfaces whose anti-slip values are among those mentioned above and the available colours.

For floors that do not have to fulfil specific anti-slip values, please refer to the Casalgrande Padana general catalogue.

Casalgrande Padana dispose d'un large éventail de produits pour sols et murs des zones complémentaires des piscines, telles que vestiaires, douches, solariums ou autres surfaces antidérapantes.

L'éventail des revêtements muraux concerne plusieurs collections et format pour offrir des alternatives de couleur à la gamme spécifique pour piscines.

Pour les revêtements de sol, la sélection inclut la gamme Technic et ne comprend que les références qui ont un classement antidérapant pieds nus de groupe B (minimum nécessaire pour les surfaces habituellement mouillées) et de groupe C (pour les surfaces normalement immergées), conformément aux dispositions de la norme allemande DIN 51097.

Dans cette section, sont indiquées exclusivement les surfaces dont les valeurs antiglissance sont comprises parmi celles susmentionnées et les couleurs disponibles.

Pour tous les sols qui ne doivent pas respecter des valeurs anti-glissance spécifiques, consulter le catalogue général de Casalgrande Padana.

Im Sortiment von Casalgrande Padana kann man verschiedene Produkte finden, die für die Fußböden und Verkleidungen der zum Schwimmbad gehörenden Bereiche geeignet sind, wie Umkleidekabinen, Duschen, Sonnenstudios oder andere Bereiche mit Rutschgefahr.

Die Auswahl von Wandverkleidungen umfasst verschiedene Kollektionen und Formate, um Farbvariationen zum spezifischen Programm für Schwimmbäder anzubieten.

Für die Fußböden werden die Produkte der Serie Technic mit Rutschfestigkeitskoeffizienten der Gruppe B bei barfüßigem Betreten illustriert (erforderlicher Mindestwert für überwiegend feuchte Bereiche) und der Gruppe C (erforderlicher Mindestwert für überwiegend unter Wasser liegende Bereiche), die entsprechend der deutschen Norm DIN 51097 gemessen werden.

In diesen Bereich sind nur die Oberflächen aufgenommen, die den oben erwähnten Rutschfestigkeitskoeffizienten entsprechen, sowie die Mindestauswahl der verfügbaren Farben.

Für sonstige Fußböden, die keinen besonderen Rutschfestigkeitskoeffizienten erforderlich machen, wird auf das breite Sortiment des allgemeinen Katalogs von Casalgrande Padana verwiesen.



Brickworks

NUANCES



Leggera
Minimal
Légère
Leichte

Vedi pagina: See page:
Voir page: Siehe Seite: 209

MURETTO



Accentuata
Accentuated
Importante
Starke

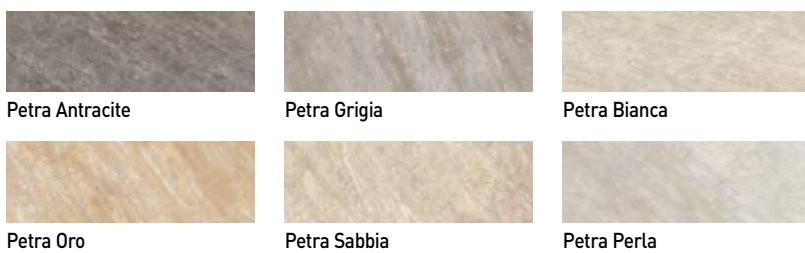

Vedi pagina: See page:
Voir page: Siehe Seite: 209

PETRA



Accentuata
Accentuated
Importante
Starke

Vedi pagina: See page:
Voir page: Siehe Seite: 209

	NUANCES	MURETTO	PETRA
Formati Sizes Formats Formate	 cm 8,2x25* 3 1/4" x 9 7/8"	 cm 8,2x25* 3 1/4" x 9 7/8"	 cm 8,2x25* 3 1/4" x 9 7/8"
Spessori Thicknesses Epaisseurs Stärken	mm 9	mm 9	mm 9
Superfici Surfaces Surfaces Oberflächen	● ●	●	●

* Non rettificato Unrectified Non rectifié Nicht kalibriert

● Lux
● Satin
● Naturale



Atelier



Rubino

Ottanio

Fiordaliso

Lavanda



Uniforme
Uniform
Uniforme
Einheitliche

Vedi pagina: See page:
Voir page: Siehe Seite: **209**



Indaco



Oltremare

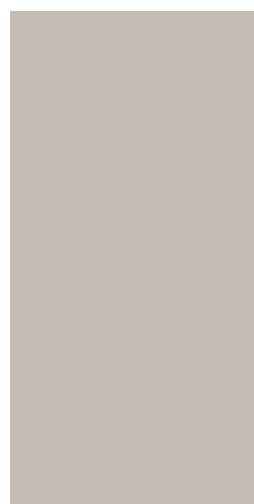

Brume

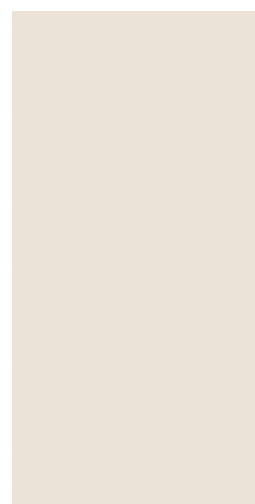

Cristallo

Kontinua

Grandi Lastre Big Slabs
Grandes Dalles Große Platten



cm 40x120
15^{3/4}"x47^{1/4}"



cm 60x120
23^{5/8}"x47^{1/4}"



cm 120x120
47^{1/4}"x47^{1/4}"



cm 120x278
47^{1/4}"x109^{1/2}"

Formati Sizes
Formats Formate

Spessori Thicknesses
Epaisseurs Stärken

Superfici Surfaces
Surfaces Oberflächen

mm 6

mm 6

mm 6

mm 6



● Naturale

Rettificate in un unico calibro Rectified version in a single caliber Rectifiés en un unique calibre Boden Sie in einem einzigen Kaliber

Negli ambienti ad alto traffico si consiglia l'uso solo a rivestimento In high-footfall settings, it is advisable to use these tiles only as wall coverings Dans les espaces à forte circulation, il est conseillé de l'utiliser uniquement comme revêtement de mur In stark beanspruchten Bereichen wird nur eine Verwendung als Verkleidung empfohlen



Caleidoscopio

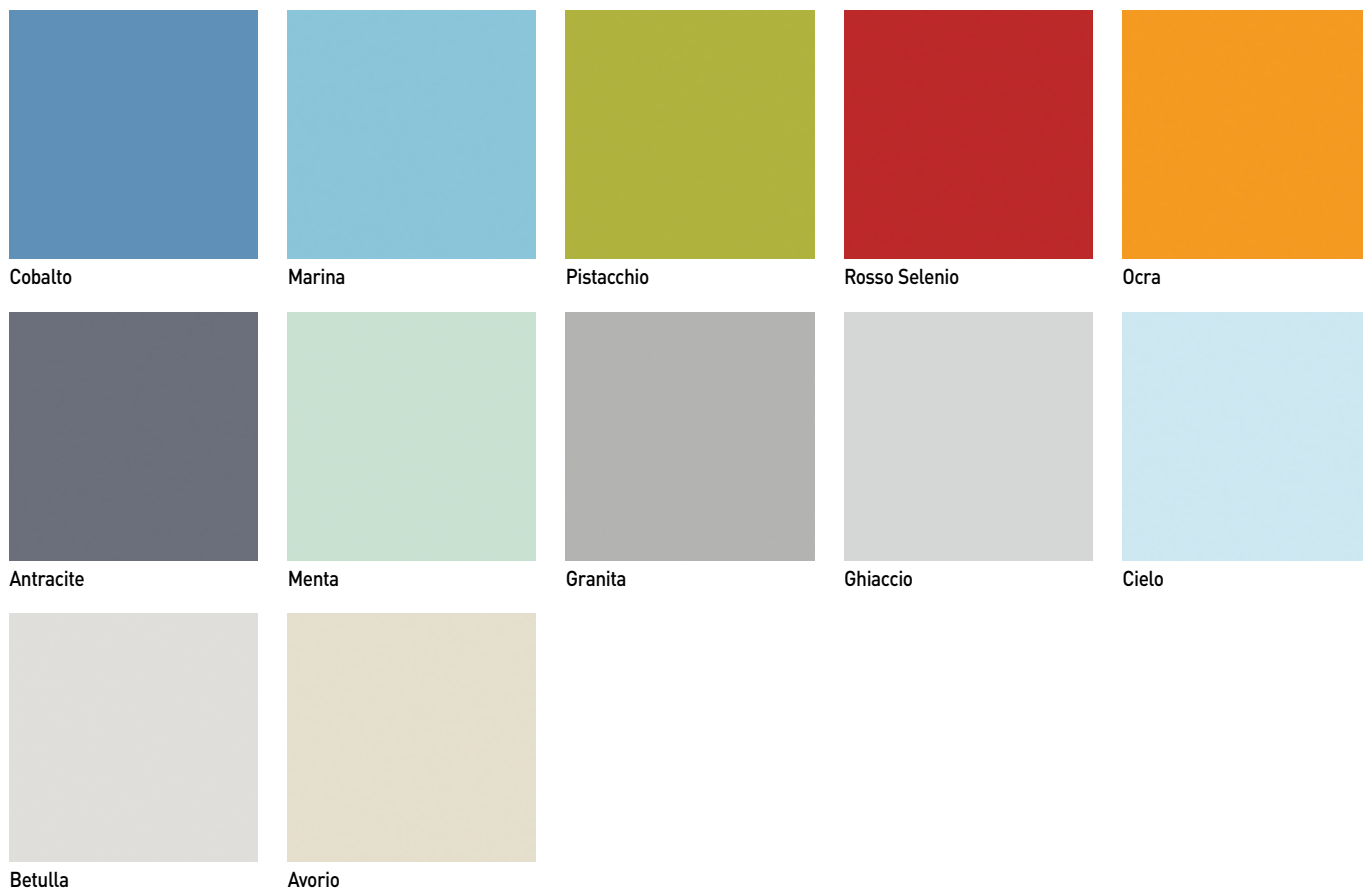

Uniforme
Uniform
Uniforme
Einheitliche

Vedi pagina: See page: Voir page: Siehe Seite: 209



Formati Sizes
Formats Formate

cm 20x20
7^{7/8}" x 7^{7/8}"

Spessori Thicknesses
Epaisseurs Stärken

mm 7,3

Superfici Surfaces
Surfaces Oberflächen



● Naturale

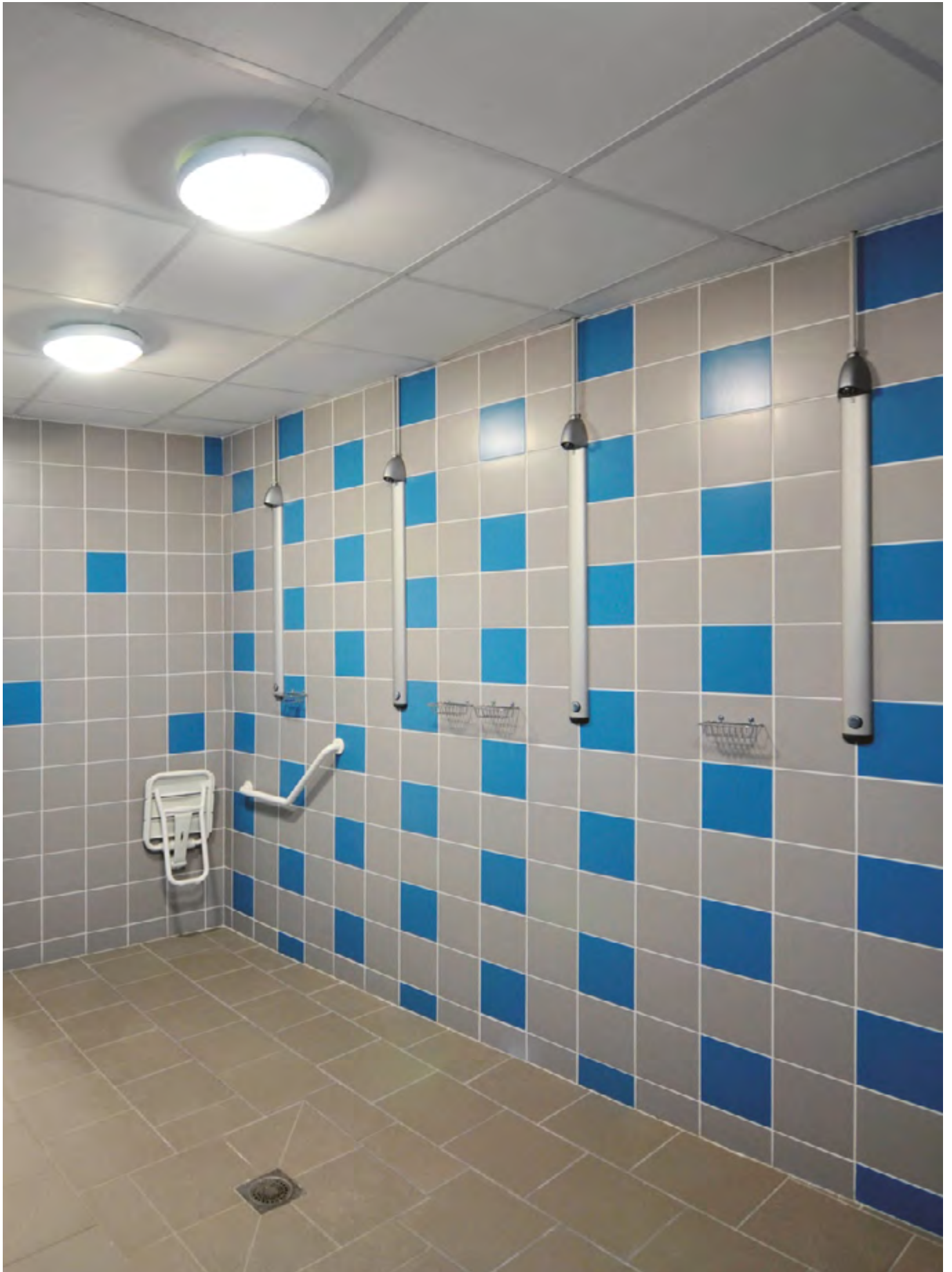

Technic



Grigio Cenere



Bianco Avorio



Bianco B









Nebraska



Arkansas



Ontario

Formati Sizes Formats Formate	 cm 20x20 7 ⁷ / ₈ "x7 ⁷ / ₈ "	 cm 20x20 7 ⁷ / ₈ "x7 ⁷ / ₈ "	 cm 20x20 7 ⁷ / ₈ "x7 ⁷ / ₈ "	 cm 30x30 11 ³ / ₄ "x11 ³ / ₄ "	 cm 30x30 11 ³ / ₄ "x11 ³ / ₄ "	 cm 30x30 11 ³ / ₄ "x11 ³ / ₄ "
Spessori Thicknesses Epaisseurs Stärken	mm 8	mm 12	mm 14	mm 8	mm 11,2	mm 14
Granito 1 Arkansas	● ● ● ● ● ●	● ● ● ● ● ●	● ● ● ● ● ●	● ●	● ●	● ●
Granito 1 Nebraska	● ● ● ● ● ●	● ● ● ● ● ●	● ● ● ● ● ●	● ●	● ●	● ●
Granito 1 Ontario	● ● ● ● ● ●	● ● ● ● ● ●	● ● ● ● ● ●	● ●	● ●	● ●
Unicolore Bianco Avorio	● ● ● ● ● ●	● ● ● ● ● ●	● ● ● ● ● ●	● ●	● ●	● ●
Unicolore Bianco B	● ● ● ● ● ●	● ● ● ● ● ●	● ● ● ● ● ●	● ●	● ●	● ●
Unicolore Grigio Cenere	● ● ● ● ● ●	● ● ● ● ● ●	● ● ● ● ● ●	●	● ●	●

- Roccia
- Bugnato
- Profil
- Pavé
- Secura
- Reticolo

pavimenti antiscivolo / non slip floor tiles / carreaux de sols antiderapants / trittsichere bodenplatten

● Secura

DIN 51097 B	XP P 05-010 PN 18	
DIN 51130 R 11	XP P 05-010 PC 20	



● Roccia

DIN 51097 B	XP P 05-010 PN 18	
DIN 51130 R 11	XP P 05-010 PC 20	



● Pavé

DIN 51097 C	XP P 05-010 PN 24	
DIN 51130 R 11 V 4	XP P 05-010 PC 20	



● Bugnato

DIN 51097 C	XP P 05-010 PN 24	
DIN 51130 R 11 V 6	XP P 05-010 PC 20	

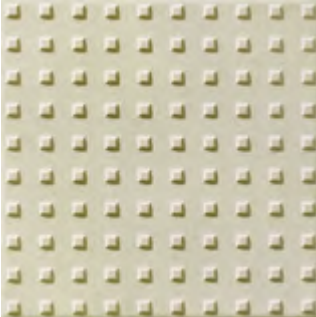

● Reticolo

DIN 51097 C	XP P 05-010 PN 24	
DIN 51130 R 12 V 4	XP P 05-010 PC 27	



● Profil

DIN 51097 C	XP P 05-010 PN 24	
DIN 51130 R 12 V 8	XP P 05-010 PC 27	



TECH INFO

CARATTERISTICHE TECNICHE













TECHNICAL FEATURES

CARACTERISTIQUES TECHNIQUES

TECHNISCHE EIGENSCHAFTEN

Caratteristiche tecniche

TECHNICAL FEATURES / CARACTERISTIQUES TECHNIQUES / TECHNISCHE EIGENSCHAFTEN

GRANITOGRES		 PT0050	NORMA STANDARDS NORME NORM
	classificazione prodotto product classification classement Klassifizierung		UNI EN 14411-G ISO 13006
	caratteristiche dimensionali e d'aspetto dimensional and surface quality caractéristiques de la surface Oberflächenqualität		UNI EN ISO 10545-2
	assorbimento di acqua water absorption absorption d'eau Wasseraufnahme		UNI EN ISO 10545-3
	resistenza alla flessione flexural strength résistance à la flexion Biegezug-Festigkeit		UNI EN ISO 10545-4
	resistenza al gelo frost resistance résistance au gel Frostwiderstandsfähigkeit		qualsiasi norma all standards toute norme Alle normen
	resistenza attacco chimico (esclusione acido fluoridrico) resistance to acids and alkalis (with the exception of hydrofluoric acid) résistance à l'attaque chimique (exclusion de l'acide fluorhydrique) Säure und Laugen Beständigkeit (mit Ausnahme von Fluorwasserstoff)		UNI EN ISO 10545-13
	resistenza usura e abrasione wear and abrasion resistance résistance à l'usure et abrasion Abriebhärte		UNI EN ISO 10545-6
	dilatazione termica lineare linear thermal expansion coefficient linéaire de dilatation thermique Lineare Wärmeausdehnung		UNI EN ISO 10545-8
	resistenza alle macchie stain resistance résistance aux taches Fleckenfestigkeit		UNI EN ISO 10545-14
	resistenza alla scivolosità (Superficie Naturale) slip resistance (Matt surface) résistance au glissement (Surface naturelle) Trittsicherheit (Natur Oberflächen)		DIN 51130
			D.M. N° 236 del 14.06.89 Metodo B.C.R.
			BS7976-2:2002 BSEN13036-4:2011
	resistenza dei colori alla luce colour resistance to sunlight exposure résistance de la couleur à la lumière Unveränderlichkeit der Farben wenn Strahlung zugesetzt wird		DIN 51094

* Valore indicativo Approx value donnée approximative Ungefähre Werte

** Prova su superficie asciutta Test on a dry surface Essai sur surface sèche Test auf trockener Oberfläche

◆ Si rimanda all'elenco prodotti UPEC ufficiale, consultabile sul sito: Please see the official UPEC product list: Veuillez consulter la liste officielle produits UPEC: Siehe die offizielle UPEC-Produktliste auf der Website: <http://webapp.cstb.fr/upec-ceramique/>

All pari dei materiali naturali di riferimento, l'aspetto estetico, la differenza di tono e le venature possono essere diverse da piastrella a piastrella.

Per una corretta comprensione della variabilità del prodotto è consigliabile prendere visione delle immagini a tutto ambiente sul catalogo di collezione, sul nostro sito all'indirizzo www.casalgrandepadana.it o chiedere maggiori informazioni ai nostri concessionari.

Just like the natural materials they are inspired by, the aesthetics, colouration and veining of the tiles can differ. To properly gauge the suitability of a product, we advise that you view the full-space photos that you can find in our collection catalogue and on our website at www.casalgrandepadana.com. Alternatively, please ask a reseller for more information.

caratteristiche tecniche / technical features / caractéristiques techniques / technische eigenschaften



RISULTATO PROVA* TEST RESULTS* RESULTATS DES ESSAIS* ERGEBNISSWE*	ASTM STANDARDS	RISULTATO PROVA TEST RESULTS RESULTATS DES ESSAIS ERGEBNISSE
gruppo B1a UGL completamente greificato group B1a UGL fully vitrified group B1a UGL grès cérame fin Gruppe B1a UGL Feinsteinzeug		
tolleranze minime nella 1ª scelta very low tolerance des tolérances minimales en 1er choix Entspricht Normen		
< 0,1%	ASTM C-373 impervious ≤ 0,5%	< 0,1%***
45 N/mm ²	ASTM C-648 breaking strength ≥ 250 lbf	425 lbf*** 625 lbf****
garantita guaranteed garantie Frostsicher	ASTM C-1026 no sample must show alterations to surface	resistente resistant
A	ASTM C-650 no sample must show alterations to surface	inalterata unaffected
≤ 150 mm ³	ASTM C-1243 < 175 mm ³	≤ 150 mm ³
6 x 10 ⁻⁶		
4-5 garantita guaranteed garantie garantiert		
vedere singole superfici see every surfaces voir les surfaces une par une siehe einzelne Oberfläche	ASTM A137.1-2012	vedere singole serie see every series voir les séries une par une Siehe einzelne Serie
valore μ > 0,40**	DCOF solo zone umide wet areas only	vedere singole serie see every series voir les séries une par une Siehe einzelne Serie
PTV > 36**		
nessuna variazione no change of colours couleurs inchangées Keinerlei Farbänderung		

*** Test made on Granito 1, Arizona Matt

**** Test made on Marte Series

Tout comme pour les matières naturelles de référence, la différence de tonalité, les veines ainsi que l'aspect esthétique peuvent varier d'une dalle à l'autre. Pour bien comprendre la variabilité du produit, il est conseillé de consulter les images d'ambiance présentes sur le catalogue de la collection, sur notre site à l'adresse www.casalgrandepadana.fr ou de demander plus d'informations à nos concessionnaires.

Wie bei den als Vorbild dienenden Naturmaterialien können sich auch hier das ästhetische Erscheinungsbild, der Farbtonunterschied und die Maserung von Fliese zu Fliese unterscheiden. Um die Variabilität des Produkts besser zu verstehen, raten wir Ihnen, die Bilder mit ausgestatteten Räumen im Kollektionskatalog auf unserer Website www.casalgrandepadana.de zu konsultieren. Weitere Informationen können Sie auch bei unseren Vertragshändlern erhalten.

Caratteristiche tecniche

TECHNICAL FEATURES / CARACTERISTIQUES TECHNIQUES / TECHNISCHE EIGENSCHAFTEN



GRESPLUS



NORMA STANDARDS NORME NORM

RISULTATO PROVA* TEST RESULTS* RESULTATS DES ESSAIS* ERGEBNISSWE*

	classificazione prodotto product classification classement Klassifizierung	UNI EN 14411-G ISO 13006	gruppo B1a completamente greificato group B1a fully vitrified group B1a grès cérame fin Gruppe B1a Feinsteinzeug
	caratteristiche dimensionali e d'aspetto dimensional and surface quality caractéristiques de la surface Oberflächenqualität	UNI EN ISO 10545-2	tolleranze minime nella 1ª scelta very low tolerance des tolérances minimales en 1er choix Entspricht Normen
	assorbimento di acqua water absorption absorption d'eau Wasseraufnahme	UNI EN ISO 10545-3	< 0,1%
	resistenza alla flessione flexural strength résistance à la flexion Biegezug-Festigkeit	UNI EN ISO 10545-4	45 N/mm ²
	resistenza al gelo frost resistance résistance au gel Frostwiderstandsfähigkeit	qualsiasi norma all standards toute norme Alle normen	garantita guaranteed garantie Frostsicher
	resistenza attacco chimico (esclusione acido fluoridrico) resistance to acids and alkalis (with the exception of hydrofluoric acid) résistance à l'attaque chimique (exclusion de l'acide fluorhydrique) Säure und Laugen Beständigkeit (mit Ausnahme von Fluorwasserstoff)	UNI EN ISO 10545-13	A
	resistenza usura e abrasione wear and abrasion résistance résistance à l'usure et abrasion Abriebhärte	UNI EN ISO 10545-6	≤ 150 mm ³
	dilatazione termica lineare linear thermal expansion coefficient linéaire de dilatation thermique Lineare Wärmeausdehnung	UNI EN ISO 10545-8	6 x 10 ⁻⁶
	resistenza alle macchie stain resistance résistance aux taches Fleckenfestigkeit	UNI EN ISO 10545-14	4-5 garantita guaranteed garantie garantiert
	resistenza alla scivolosità (Superficie Naturale) slip resistance (Matt surface) résistance au glissement (Surface naturelle) Trittsicherheit (Natur Oberflächen)	DIN 51130 D.M. N° 236 del 14.06.89 Metodo B.C.R. BS7976-2:2002 BSEN13036-4:2011	vedere singole serie see every series voir les séries une par une Siehe einzelne Serie valore $\mu > 0,40^{**}$ PTV > 36 ^{**}
	resistenza dei colori alla luce colour resistance to sunlight exposure résistance de la couleur à la lumière Unveränderlichkeit der Farben wenn Strahlung zugesetzt wird	DIN 51094	nessuna variazione no change of colours couleurs inchangées Keinerlei Farbänderung

* Valore indicativo Approx value donnée approximative Ungefähre Werte

** Prova su superficie asciutta Test on a dry surface Essai sur surface sèche Test auf trockener Oberfläche

◆ Si rimanda all'elenco prodotti UPEC ufficiale, consultabile sul sito: Please see the official UPEC product list: Veuillez consulter la liste officielle produits UPEC: Siehe die offizielle UPEC-Produktliste auf der Website: <http://webapp.cstb.fr/upec-ceramique/>

All pari dei materiali naturali di riferimento, l'aspetto estetico, la differenza di tono e le venature possono essere diverse da piastrella a piastrella.

Per una corretta comprensione della variabilità del prodotto è consigliabile prendere visione delle immagini a tutto ambiente sul catalogo di collezione, sul nostro sito all'indirizzo www.casalgrandepadana.it o chiedere maggiori informazioni ai nostri concessionari.

Just like the natural materials they are inspired by, the aesthetics, colouration and veining of the tiles can differ. To properly gauge the suitability of a product, we advise that you view the full-space photos that you can find in our collection catalogue and on our website at www.casalgrandepadana.com. Alternatively, please ask a reseller for more information.

Tout comme pour les matières naturelles de référence, la différence de tonalité, les veines ainsi que l'aspect esthétique peuvent varier d'une dalle à l'autre.

Pour bien comprendre la variabilité du produit, il est conseillé de consulter les images d'ambiance présentes sur le catalogue de la collection, sur notre site à l'adresse www.casalgrandepadana.fr ou de demander plus d'informations à nos concessionnaires.

Wie bei den als Vorbild dienenden Naturmaterialien können sich auch hier das ästhetische Erscheinungsbild, der Farbtonunterschied und die Maserung von Fliese zu Fliese unterscheiden. Um die Variabilität des Produkts besser zu verstehen, raten wir Ihnen, die Bilder mit ausgestatteten Räumen im Kollektionskatalog auf unserer Website www.casalgrandepadana.de zu konsultieren. Weitere Informationen können Sie auch bei unseren Vertragshändlern erhalten.



PIETRE NATIVE



NORMA STANDARDS NORME NORM

RISULTATO PROVA* TEST RESULTS* RESULTATS DES ESSAIS* ERGEBNISSWE*

	classificazione prodotto product classification classement Klassifizierung	UNI EN 14411-G ISO 13006	gruppo B1a completamente greificato group B1a fully vitrified group B1a grès cérame fin Gruppe B1a Feinsteinzeug
	caratteristiche dimensionali e d'aspetto dimensional and surface quality caractéristiques de la surface Oberflächenqualität	UNI EN ISO 10545-2	tolleranze minime nella 1ª scelta very low tolerance des tolérances minimales en 1er choix Entspricht Normen
	assorbimento di acqua water absorption absorption d'eau Wasseraufnahme	UNI EN ISO 10545-3	< 0,1%
	resistenza alla flessione flexural strength résistance à la flexion Biegezug-Festigkeit	UNI EN ISO 10545-4	45 N/mm ²
	resistenza al gelo frost resistance résistance au gel Frostwiderstandsfähigkeit	qualsiasi norma all standards toute norme Alle normen	garantita guaranteed garantie Frostsicher
	resistenza attacco chimico (esclusione acido fluoridrico) resistance to acids and alkalis (with the exception of hydrofluoric acid) résistance à l'attaque chimique (exclusion de l'acide fluorhydrique) Säure und Laugen Beständigkeit (mit Ausnahme von Fluorwasserstoff)	UNI EN ISO 10545-13	A
	resistenza usura e abrasione wear and abrasion résistance résistance à l'usure et abrasion Abriebhärte	UNI EN ISO 10545-6	≤ 150 mm ³
	dilatazione termica lineare linear thermal expansion coefficient linéaire de dilatation thermique Lineare Wärmeausdehnung	UNI EN ISO 10545-8	6 x 10 ⁻⁶
	resistenza alle macchie stain resistance résistance aux taches Fleckenfestigkeit	UNI EN ISO 10545-14	4-5 garantita guaranteed garantie garantiert
	resistenza alla scivolosità (Superficie Naturale) slip resistance (Matt surface) résistance au glissement (Surface naturelle) Trittsicherheit (Natur Oberflächen)	DIN 51130 D.M. N° 236 del 14.06.89 Metodo B.C.R. BS7976-2:2002 BSEN13036-4:2011	vedere singole serie see every series voir les séries une par une Siehe einzelne Serie valore μ > 0,40** PTV > 36**
	resistenza dei colori alla luce colour resistance to sunlight exposure résistance de la couleur à la lumière Unveränderlichkeit der Farben wenn Strahlung zugesetzt wird	DIN 51094	nessuna variazione no change of colours couleurs inchangées Keinerlei Farbänderung

* Valore indicativo Approx value donnée approximative Ungefähre Werte

** Prova su superficie asciutta Test on a dry surface Essai sur surface sèche Test auf trockener Oberfläche

◆ Si rimanda all'elenco prodotti UPEC ufficiale, consultabile sul sito: Please see the official UPEC product list: Veuillez consulter la liste officielle produits UPEC: Siehe die offizielle UPEC-Produktliste auf der Website: <http://webapp.cstb.fr/upec-ceramique/>

At pari dei materiali naturali di riferimento, l'aspetto estetico, la differenza di tono e le venature possono essere diverse da piastrella a piastrella.

Per una corretta comprensione della variabilità del prodotto è consigliabile prendere visione delle immagini a tutto ambiente sul catalogo di collezione, sul nostro sito all'indirizzo www.casalgrandepadana.it o chiedere maggiori informazioni ai nostri concessionari.

Just like the natural materials they are inspired by, the aesthetics, colouration and veining of the tiles can differ. To properly gauge the suitability of a product, we advise that you view the full-space photos that you can find in our collection catalogue and on our website at www.casalgrandepadana.com. Alternatively, please ask a reseller for more information.

Tout comme pour les matières naturelles de référence, la différence de tonalité, les veines ainsi que l'aspect esthétique peuvent varier d'une dalle à l'autre.













Pour bien comprendre la variabilité du produit, il est conseillé de consulter les images d'ambiance présentes sur le catalogue de la collection, sur notre site à l'adresse www.casalgrandepadana.fr ou de demander plus d'informations à nos concessionnaires.

Wie bei den als Vorbild dienenden Naturmaterialien können sich auch hier das ästhetische Erscheinungsbild, der Farbtonunterschied und die Maserung von Fliese zu Fliese unterscheiden. Um die Variabilität des Produkts besser zu verstehen, raten wir Ihnen, die Bilder mit ausgestatteten Räumen im Kollektionskatalog auf unserer Website www.casalgrandepadana.de zu konsultieren. Weitere Informationen können Sie auch bei unseren Vertragshändlern erhalten.

Caratteristiche tecniche

TECHNICAL FEATURES / CARACTERISTIQUES TECHNIQUES / TECHNISCHE EIGENSCHAFTEN



GRANITOKER	 PT0078	NORMA STANDARDS NORME NORM	RISULTATO PROVA* TEST RESULTS* RESULTATS DES ESSAIS* ERGEBNISSWE*
	classificazione prodotto product classification classement Klassifizierung	UNI EN 14411-G ISO 13006	gruppo B1a completamente greificato group B1a fully vitrified group B1a grès cérame fin Gruppe B1a Feinsteinzeug
	caratteristiche dimensionali e d'aspetto dimensional and surface quality caractéristiques de la surface Oberflächenqualität	UNI EN ISO 10545-2	tolleranze minime nella 1ª scelta very low tolerance des tolérances minimales en 1er choix Entspricht Normen
	assorbimento di acqua water absorption absorption d'eau Wasseraufnahme	UNI EN ISO 10545-3	< 0,1%
	resistenza alla flessione flexural strength résistance à la flexion Biegezug-Festigkeit	UNI EN ISO 10545-4	45 N/mm ²
	resistenza al gelo frost resistance résistance au gel Frostwiderstandsfähigkeit	qualsiasi norma all standards toute norme Alle normen	garantita guaranteed garantie Frostsicher
	resistenza attacco chimico (esclusione acido fluoridrico) resistance to acids and alkalis (with the exception of hydrofluoric acid) résistance à l'attaque chimique (exclusion de l'acide fluorhydrique) Säure und Laugen Beständigkeit (mit Ausnahme von Fluorwasserstoff)	UNI EN ISO 10545-13	A
	resistenza usura e abrasione wear and abrasion résistance résistance à l'usure et abrasion Abriebhärte	UNI EN ISO 10545-6	≤ 150 mm ³
	dilatazione termica lineare linear thermal expansion coefficient linéaire de dilatation thermique Lineare Wärmeausdehnung	UNI EN ISO 10545-8	6 x 10 ⁻⁶
	resistenza alle macchie stain resistance résistance aux taches Fleckenfestigkeit	UNI EN ISO 10545-14	4-5 garantita guaranteed garantie garantiert
	resistenza alla scivolosità (Superficie Naturale) slip resistance (Matt surface) résistance au glissement (Surface naturelle) Trittsicherheit (Natur Oberflächen)	DIN 51130	vedere singole serie see every series voir les séries une par une Siehe einzelne Serie
		D.M. N° 236 del 14.06.89 Metodo B.C.R.	valore $\mu > 0,40^{**}$
		BS7976-2:2002 BSEN13036-4:2011	PTV > 36 ^{**}
	resistenza dei colori alla luce colour resistance to sunlight exposure résistance de la couleur à la lumière Unveränderlichkeit der Farben wenn Strahlung zugesetzt wird	DIN 51094	nessuna variazione no change of colours couleurs inchangées Keinerlei Farbänderung

* Valore indicativo Approx value donnée approximative Ungefähre Werte

** Prova su superficie asciutta Test on a dry surface Essai sur surface sèche Test auf trockener Oberfläche

◆ Si rimanda all'elenco prodotti UPEC ufficiale, consultabile sul sito: Please see the official UPEC product list: Veuillez consulter la liste officielle produits UPEC: Siehe die offizielle UPEC-Produktliste auf der Website: <http://webapp.cstb.fr/upec-ceramique/>

All pari dei materiali naturali di riferimento, l'aspetto estetico, la differenza di tono e le venature possono essere diverse da piastrella a piastrella.

Per una corretta comprensione della variabilità del prodotto è consigliabile prendere visione delle immagini a tutto ambiente sul catalogo di collezione, sul nostro sito all'indirizzo www.casalgrandepadana.it o chiedere maggiori informazioni ai nostri concessionari.

Just like the natural materials they are inspired by, the aesthetics, colouration and veining of the tiles can differ. To properly gauge the suitability of a product, we advise that you view the full-space photos that you can find in our collection catalogue and on our website at www.casalgrandepadana.com. Alternatively, please ask a reseller for more information.

Tout comme pour les matières naturelles de référence, la différence de tonalité, les veines ainsi que l'aspect esthétique peuvent varier d'une dalle à l'autre.

Pour bien comprendre la variabilité du produit, il est conseillé de consulter les images d'ambiance présentes sur le catalogue de la collection, sur notre site à l'adresse www.casalgrandepadana.fr ou de demander plus d'informations à nos concessionnaires.

Wie bei den als Vorbild dienenden Naturmaterialien können sich auch hier das ästhetische Erscheinungsbild, der Farbtonunterschied und die Maserung von Fliese zu Fliese unterscheiden. Um die Variabilität des Produkts besser zu verstehen, raten wir Ihnen, die Bilder mit ausgestatteten Räumen im Kollektionskatalog auf unserer Website www.casalgrandepadana.de zu konsultieren. Weitere Informationen können Sie auch bei unseren Vertragshändlern erhalten.

caratteristiche tecniche / technical features / caractéristiques techniques / technische eigenschaften
variazioni cromatiche / chromatic variations / variations chromatiques / farbtonabweichungen

Variazioni cromatiche

CHROMATIC VARIATIONS / VARIATIONS CHROMATIQUES / FARBTONABWEICHUNGEN

Indica il livello di variazione cromatica che sussiste all'interno della stessa collezione fra una piastrella e l'altra.

The scale denotes the level of colour variation that exists between specific tiles in the same collection.

C'est le degré de variation chromatique qui existe entre un carreau et un autre de la même collection.

Das zeigt die Einstufung der chromatischen Variation, die innerhalb den verschiedenen Fliesen der selben Kollektion entsteht.

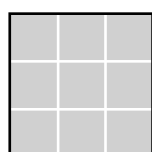

Uniforme
Uniform
Uniforme
Einheitliche

V1

L'aspetto delle piastrelle è uniforme. Differenze minime fra i prodotti appartenenti al medesimo lotto produttivo.

The appearance of the tiles is uniform. There are minimal differences in products belonging to the same production batch.

L'aspect des carreaux est uniforme. Les différences entre les produits appartenant à un même lot de production sont minimes.

Der optische Aspekt der Fliesen ist einheitlich. Die Unterschiede zwischen Produkten derselben Produktionscharge sind minimal.

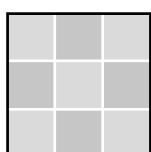

Leggera
Minimal
Légère
Leichte

V2

L'aspetto delle piastrelle presenta leggere ma visibili differenze, che si tratti di segni grafici o sfumature/venature tipiche del materiale naturale di riferimento.

There are subtle yet visible differences in the appearance of the tile, whether these are clear markings or the typical shading/veining of the natural material in question.

L'aspect des carreaux présente des différences légères mais visibles, qu'il s'agisse de marques graphiques ou de nuances/veinures typiques du matériau naturel de référence.

Der optische Aspekt der Fliesen weist leichte aber sichtbare Unterschiede auf, wobei es sich um graphische Zeichnungen oder Schattierungen/Maserungen handelt, die für das natürliche Referenzmaterial typisch sind.

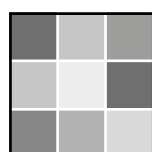

Media
Medium
Modérée
Mittlere

V3

L'aspetto delle piastrelle presenta variazioni di colore e/o struttura decisi. Questa variabilità cromatica è appositamente studiata in fase di progettazione della collezione per rendere il prodotto il più vicino possibile al materiale naturale di riferimento.

There are clear variations in the colour and/or structure of the tiles. This dynamic colour variation is meticulously planned during the collection design phase in order to make the product as similar as possible to the natural material in question.

L'aspect des carreaux présente des variations de couleur et/ou de structure marquées. Le caractère variable de la couleur est spécialement étudié lors de la conception de la collection pour rendre le produit le plus proche possible du matériau naturel de référence.

Der optische Aspekt der Fliesen weist deutliche Farb- und/oder Strukturunterschiede auf. Diese chromatische Variabilität wurde in der Designphase der Kollektion speziell entwickelt, um das Produkt seinem natürlichen Referenzmaterial so ähnlich wie möglich zu machen.



Accentuata
Accentuated
Importante
Starke

V4

L'aspetto delle piastrelle presenta variazioni importanti di colore e/o di struttura, rendendole, in alcuni casi, completamente diverse tra loro.

There are significant variations in the colour and/or structure of the tiles. In some cases, one tile can appear completely different to the next.

L'aspect des carreaux présente d'importantes variations de couleur et/ou de structure, ce qui les rend, dans certains cas, complètement différentes entre elles.

Der optische Aspekt der Fliesen weist bedeutende Farb- und/oder Strukturunterschiede auf, durch die sie sich in einigen Fällen vollständig voneinander abheben.

Mosaici

MOSAICS / MOSAÏQUE / MOSAIKEN

MOSAICO CON RETE DAVANTI MOSAIC WITH NET ON GOOD FACE MOSAÏQUE AVEC TRAME SUR BELLE FACE GELIEFERT MIT NETZ AUF DER VORDERSEITE

Adatto sia per zone secche e zone umide

Suited both for dry and humid zones

Adaptée soit pour zones sèches soit pour zones humides

Geeignet für trockene und nasse Oberflächen

Davanti del foglio
Front view of the sheet
Devant de la plaque
Vorderer Teil des Blattes

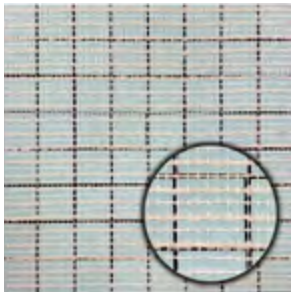

Retro del foglio
Back view of the sheet
Arrière de la plaque
Hinterer Teil des Blattes

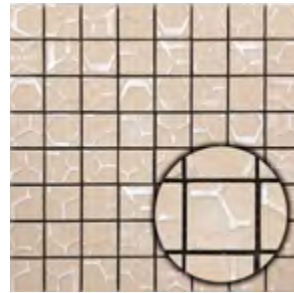

MOSAICO SU RETE MOSAIC ON NET MOSAÏQUE SUR TRAME MOSAÏK AUF NETZ

Consigliato soltanto per zone secche

Suggested for dry zones only

Suggérée uniquement pour zones sèches

Geeignet nur für trockene Oberfläche

Davanti del foglio
Front view of the sheet
Devant de la plaque
Vorderer Teil des Blattes

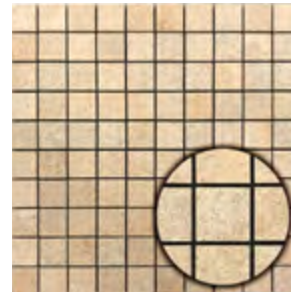

Retro del foglio
Back view of the sheet
Arrière de la plaque
Hinterer Teil des Blattes

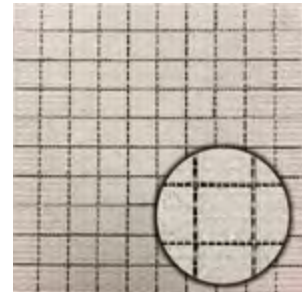

Una volta estratti dalle scatole, i fogli devono essere maneggiati con cura, senza scuoterli eccessivamente

Once out of the boxes the sheets must be handled with care, avoiding to shake them excessively

Dès que les plaques ont été retirées des boîtes, il faut les manipuler avec précaution, sans les agiter excessivement

Sobald sie aus den Boxen extrahiert werden, müssen die Blätter mit Sorgfalt behandelt werden, ohne sie übermäßig zu schütteln

MOSAICO CON RETE DAVANTI - ISTRUZIONI D'USO MOSAIC WITH NET ON GOOD FACE - INSTRUCTIONS FOR USE MOSAÏQUE AVEC TRAME SUR BELLE FACE - NOTICE D'UTILISATION GELIEFERT MIT NETZ AUF DER VORDERSEITE - GEBRAUCHSANWEISUNGEN

- Procedere con il normale incollaggio dei fogli di mosaico e attendere il tempo necessario per l'asciugatura della colla.
- Con l'ausilio di un rullo o di una spugna, bagnare abbondantemente i fogli di mosaico già posti in opera e attendere qualche minuto.
- Procedere con la rimozione della rete che dovrà essere asportata intera.
- L'eventuale uso di acqua calda o tiepida può ulteriormente facilitare le operazioni di rimozione della rete.
- Con l'ausilio di una spugna o di una spazzola procedere alla pulizia delle tessere per rimuovere eventuali residui di colla.
- Procedere infine con la stuccatura delle fughe.
- The mosaic sheets must be glued as usual, then wait the time necessary for the drying of the glue
- The mosaics sheets already fixed must be generously wet with the help of a roller or a sponge. Then for a few minutes.
- The net can be removed and must be removed entire.
- The eventual use of warm or hot water may further help the removal of the net.
- The mosaic tiles must be cleaned with the help of a sponge or a brush in order to remove any residual glue.
- Carry on with the grouting of the joint.
- Procéder avec l'habituel collage des plaques et attendre le temps nécessaire pour le séchage de la colle.
- À l'aide d'un rouleau ou d'une éponge, mouiller abondamment les plaques de mosaïque mises en place et attendre quelques minutes.
- Procéder avec l'enlèvement de la trame qui doit être retirée entière.
- L'éventuelle utilisation d'eau tiède ou chaude peut faciliter l'enlèvement de la trame davantage
- À l'aide d'une éponge ou d'une brosse, nettoyer les tesselles afin d'élever les éventuelles résidus de colle
- Procéder avec le jointoiment.
- Mit dem normalen Kleben der Mosaikfolie fortfahren und bis zum Trocknen warten.
- Mit Hilfe einer Walze oder eines Schwamms die bereits bearbeiteten Mosaikblätter gründlich bewässern und einige Minuten warten lassen.
- Anschließend das Netz vollständig entfernen.
- Die mögliche Verwendung von warmem oder lauwarmem Wasser kann das Entfernen des Netzes zusätzlich erleichtern.
- Reinigen Sie die Steine mit Hilfe eines Schwamms oder einer Bürste, um allfällige Klebereste zu entfernen.
- Danach verfugen.

Manutenzione e pulizia

Dopo la posa è sempre necessario proteggere i pavimenti e rivestimenti ceramici e bisogna assolutamente evitare di camminare a piedi calzati su ceramiche indicate per esclusivo uso a piedi nudi.

In base alle dimensioni della superficie da trattare la manutenzione potrà poi essere meccanizzata oppure manuale.

La manutenzione delle piastrelle per piscine in gres porcellanato non smaltato **Granitogres** e smaltato **Gresplus** non richiede in genere particolari cure se non le seguenti norme di pulizia.

Prima pulizia

La prima pulizia si esegue normalmente una sola volta dopo la posa delle ceramiche e prima dell'uso del pavimento/ rivestimento in quanto ha lo scopo di eliminare ogni traccia di cemento, colla e/o stucco conseguente alla posa e sigillatura delle fughe.

Una volta asportati i residui e detriti più grossolani presenti sul pavimento si può procedere nel modo seguente:

- 1) Inumidire con acqua la superficie affinché le fughe vengano impregnate e pertanto protette dalla azione corrosiva del detergente a componente acida (decalcificante).
- 2) Stendere il detergente (vedi nota A) nella concentrazione (rapporto di miscelazione con l'acqua) indicata dal produttore applicandolo con una spazzola manuale o motorizzata evitando il contatto con eventuali componenti in acciaio, alluminio e marmo naturale adiacenti al pavimento/ rivestimento.
- 3) Durante il tempo di azione, che deve essere stabilito in relazione allo stato del pavimento, strofinare lo sporco più ostinato e raschiare

eventuali residui di malta, stucco ecc.

- 4) Sciacquare infine il pavimento/ rivestimento con acqua pulita e raccogliere subito l'acqua sporca manualmente o con apparecchio lavasciuga.

Se la prima pulizia viene eseguita dopo che il pavimento/ rivestimento è già stato usato, sarà bene, prima di applicare il detergente a base acida, rimuovere con appositi detergenti alcalini (sgrassanti) eventuali presenze di sostanze grasse o simili (vedi paragrafo "pulizia ordinaria").

L'operazione di prima pulizia, se ritenuto necessario, può essere ripetuta.

A seguito del primo lavaggio acido le ceramiche con finitura superficiale Levigata, Lappata o Lucida possono evidenziare una leggera diminuzione della lucentezza che deve essere considerata normale in quanto dovuta alla eliminazione dei residui degli abrasivi utilizzati nella lavorazione della superficie.

L'impiego di detergenti a base di acido fosforico è da preferire a quelli a base di acido cloridrico in quanto meno aggressivi verso i metalli.

- A) Alcuni detergenti consigliati per eliminare i residui di stucco:

Fughe realizzate con stucco cementizio – detergenti a componente acida (decalcificanti)

Deterprimo Plus (Casalgrande Padana), Deterdek (Fila), Keranet (Mapei), Deltaplus (Kerakoll), Solvacid (Geal) o simili (seguire le istruzioni del produttore del detergente).

Fughe realizzate con stucco epossidico – detergenti a componente alcalina

Fuga-Soap Eco (Kerakoll), Kerapoxy Cleaner (Mapei), Tile Cleaner (Faber), CR10 (Fila), Lithofin Resin- Ex (Lithofin),

Eposolv (Geal) o simili (seguire le istruzioni del produttore del detergente).

Pulizia ordinaria

Per la pulizia di tutti i giorni è sufficiente lavare il pavimento/ rivestimento con acqua e aggiunta di normali prodotti detergenti adatti a pulire superfici ceramiche (per i rivestimenti murali usare detergenti in gel).

Assicurarsi che i detergenti non contengano sostanze cerose; la superficie dei prodotti Casalgrande Padana, essendo praticamente in assorbente, non richiede l'applicazione di cere e/o prodotti siliconici di protezione che, al contrario, non devono mai essere usati in quanto possono creare un film superficiale che andrebbe a modificare le caratteristiche naturali del gres porcellanato.

In presenza di macchie persistenti e difficili da togliere con la pulizia ordinaria, intervenire con l'impiego di detergenti più concentrati lasciando agire gli stessi per un adeguato intervallo di tempo e, successivamente, strofinare con adeguata intensità fino a ricondurre le piastrelle all'aspetto originario.

Al riguardo è opportuno segnalare che il gres è resistente a qualsiasi sostanza chimica, eccezion fatta per l'acido fluoridrico che attacca tutti i prodotti ceramici e che quindi non deve mai essere utilizzato.

Per la pulizia di pavimenti in aree pubbliche si consiglia di intervenire dopo la chiusura dei locali affinché il pavimento possa essere ben asciutto alla riapertura; in alternativa è opportuno isolare il pavimento pulito fino alla sua completa asciugatura.

Per i locali di maggiore estensione è opportuno disporre di macchine lavasciuga al fine di assicurare una perfetta pulizia e igienicità.

Il pavimento deve essere considerato pulito quando riacquista il suo aspetto originario!

Superfici antiscivolo

Per la piastrelle con superficie antiscivolo, impiegate generalmente in ambienti umidi o bagnati, bisogna tenere presente gli specifici problemi di pulizia legati al fatto che le superfici sono in genere ruvide, strutturate oppure a rilievi e impongono quindi una maggiore attenzione.

Per la pulizia di queste superfici si sono affermate come ottimali le macchine lavapavimenti a spazzole controrotanti dove l'alternanza del senso di rotazione permette alle setole di restare sempre perpendicolari al pavimento in modo da raggiungere le eventuali cavità della superficie oppure macchine a rullo.

Non bisogna in nessun caso utilizzare pads abrasivi che potrebbero abrader la superficie delle ceramiche e ridurre conseguentemente i valori antiscivolo originari.

Per le pavimentazioni di più ampie dimensioni si consiglia l'impiego di macchine provviste di dispositivi capaci di aspirare i liquidi, e con essi lo sporco, che viene convogliato e raccolto nell'apposito serbatoio.

Altro mezzo utilizzato per questo tipo di pavimenti è l'idropulitrice avendo però l'accortezza di usare pressioni moderate sulle fughe specie quelle realizzate con fuganti a base cementizia.

Maintenance and cleaning

After the installation it is always necessary to duly cover and protect the floor tiles and avoid to walk with shoes on ceramic tiles in barefoot areas.

Depending on the size of the surface you need to clean, you can choose between a mechanical or manual cleaning method.

The maintenance of Granitogres, unglazed porcelain tiles, and of Gresplus, glazed porcelain tiles, do not require any specific or particular care and the following maintenance instructions are generally enough to reach expected results.

Initial clean

The initial cleaning is normally done only once after tiles installation and before the floor/wall covering is used. The aim of this operation is to eliminate all traces of cement, adhesive and grouting materials after installation.

Once the main residues present on the flooring has been removed, you may proceed in the following way:

- 1) Apply water to the surface so that the joints become wet and therefore are protected from the corrosive properties of acid-based detergent (de-scalers).
- 2) Dilute the detergent (see Note A) with water to the ratio indicated by the manufacturer and apply using a manual or motorised brush. We recommend to avoid contact with any steel, aluminium and natural marble situated near to the floor/wall covering.
- 3) While the detergent lays for a period of time determined according to the conditions of the flooring, scrub the most stubborn dirt away and remove any grout or sealant residue.

- 4) Wash off the floor/wall covering with clean water and immediately get rid of the dirty water either manually or using a floor-cleaning machine.

If the initial cleaning is being carried out after the floor/wall covering has already been used it is necessary to first remove eventual dirt and greasy residuals using alkaline detergents (degreasers) before applying the acid based detergent (see paragraph "ordinary cleaning").

If necessary, the initial cleaning can be repeated more than once.

After the initial cleaning with the acid-based detergent, ceramic tiles with the Levigata, Lappata or Lucida finishes may show a slight reduction in shininess.

This should be considered normal as it is due to the elimination of the remnants of abrasives used to work the surfaces.

Detergents made with phosphoric acid are preferable to those made with hydrochloric acid as they are less damaging to metals.

- A) Detergents suggested for eliminating grouting residue:

Cement-based grouts – acid based detergents (descaling)

Deterprimo Plus (Casalgrande Padana), Deterdek (Fila), Keranet (Mapei), Deltaplus (Kerakoll), Solvacid (Geal) or similar (for the application follow instructions of manufacturer of detergent).

Epoxy-based sealant – alkaline based detergents

Fuga-Soap Eco (Kerakoll), Kerapoxy Cleaner (Mapei), Tile Cleaner (Faber), CR10 (Fila), Lithofin Resin-Ex (Lithofin), Eposolv (Geal) or similar (for the application follow instructions of manufacturer of detergent).

Ordinary cleaning

For everyday cleaning, simply wash the floor/wall covering with water and standard detergents suitable for use on ceramic surfaces (for walls use gel detergents).

Ensure that detergents do not contain waxy substances. Casalgrande Padana products feature virtually non-absorbent surfaces and therefore do not require the application of wax and/or silicon-based protective products. These must never be used because they could create a film on the surface which would alter the original characteristics of the porcelain stoneware.

In the event of persistent stains that are difficult to remove through normal cleaning practices use higher concentrate detergents leaving these to work for an adequate period of time and then rub down with appropriate force until the appearance of the tiles is back to normal.

Please be reminded that porcelain tiles are resistant to all chemical substances except hydrofluoric acid which damages all ceramic products and therefore must never be used.

We suggest that cleaning operations of floors in public buildings are carried out when such places are closed to ensure the floors are fully dry before being used again. Alternatively, cordon off the floor being cleaned until it has dried.

For bigger spaces, the use of a floor-cleaning machine is suggested for perfect cleaning and optimum hygiene.

Floorings should be considered clean when their original appearance has been restored.

Anti-slip surfaces

For slip resistant tiles, which are

generally used for damp or wet areas, it is necessary to consider that such surfaces are generally rough, patterned or feature reliefs and therefore require greater attention and care.

Floor-cleaning machines featuring counter-rotating brushes are excellent for cleaning these surfaces; the alternating direction of rotation means that the bristles stay perpendicular to the floor thus making possible to reach the cavities of the surface. Roller-style cleaning machines are also suitable.

Under no circumstances should abrasive pads be used as these could alter the surface of the tiles thus reducing the original non-slip values.

For larger floors we suggest the use of machines that are able to suck up the cleaning liquids and dirt together collecting them into a designated container.

Pressure washers can also be used for this type of floorings but using moderate pressures thus to avoid damaging the grouting joints, especially if these are the cement-based ones.

Entretien et nettoyage

Après la mise en place, il faut toujours protéger les carrelages et les revêtements céramiques, ainsi qu'éviter de marcher les pieds chaussés sur les céramiques dont l'utilisation est exclusivement les pieds nus.

En fonction des dimensions de la surface à traiter, l'entretien pourra être mécanisé ou manuel.

L'entretien des carreaux pour piscines en grès cérame non émaillé Granitogres et émaillé Gresplus ne demande généralement pas de soins particuliers, en dehors des normes de nettoyage ci-dessous.

Premier nettoyage

Le premier nettoyage ne s'effectue normalement qu'une seule fois après la pose des carreaux et avant l'utilisation du sol/revêtement de façon à éliminer toute trace de ciment, colle et/ou enduit après la pose et le scellement des joints.

Une fois que les plus gros résidus ont été retirés du sol, il est possible de procéder comme suit :

- 1) Mouiller la surface afin que les joints soient imprégnés d'eau et ainsi protégés de l'action corrosive du détergent acide (détartrant).
- 2) Verser le détergent (voir note A) dans la concentration (rapport mélange avec eau) indiquée par le fabricant en l'appliquant avec une brosse manuelle ou motorisée et en évitant tout contact avec d'éventuels composants en acier, aluminium et marbre naturel qui pourraient se trouver près du sol/revêtement.
- 3) Pendant que le produit agit, le temps d'action étant relatif à l'état du sol, frotter la saleté la plus incrustée et gratter les

éventuels résidus de mortier, enduit, etc.

- 4) Enfin, rincer le sol/revêtement à l'eau claire et recueillir immédiatement l'eau sale à la main ou à l'aide d'une auto-laveuse.

Si le premier nettoyage est effectué après que le sol/revêtement a déjà été utilisé, il est conseillé, avant d'appliquer le détergent acide, de retirer avec un détergent alcalin (dégraissant) les éventuelles traces de substances grasses ou semblables (voir paragraphe « nettoyage ordinaire »).

L'opération de premier nettoyage peut être répétée si nécessaire. Suite au premier nettoyage acide, la brillance des dalles en céramique à la finition polie (levigata), rodée (Lappata) ou brillante (Lucida) peut légèrement diminuer, ce qui doit être considéré comme normal étant donné l'élimination des résidus des produits abrasifs utilisés pour le travail de la surface.

Il est préférable d'utiliser des détergents à base d'acide phosphorique plutôt qu'à base d'acide chlorhydrique car ils s'avèrent moins agressifs au contact des différents métaux.

A) Détergents conseillés pour éliminer les résidus des produits de jointoiement :

Jointes réalisés avec produits à base de ciment - détergents acides (détartrants)

Deterprimo Plus (Casalgrande Padana), Deterdek (Fila), Keranet (Mapei), Deltaplus (Kerakoll), Solvacid (Geal) ou semblables (suivre les instructions du fabricant).

Jointes réalisés avec produits époxy – détergents alcalins

Fuga-Soap Eco (Kerakoll),

Kerapoxy Cleaner (Mapei), Tile Cleaner (Faber), CR10 (Fila), Lithofin Resin- Ex (Lithofin), Eposolv (Geal) ou semblables (suivre les instructions du fabricant).

Nettoyage ordinaire

Pour le nettoyage quotidien, il suffit de laver le sol/revêtement avec de l'eau et un détergent adapté aux surfaces céramiques (utiliser un détergent en gel pour les revêtements muraux).

S'assurer que le détergent ne contient aucune substance cireuse : la surface des produits Casalgrande Padana, n'étant presque pas absorbante, ne requiert pas l'application de cire et/ou de produits de protection à base de silicone.

Ces produits ne doivent, au contraire, jamais être utilisés car ils pourraient créer un film, ce qui modifierait les caractéristiques originelles du grès cérame.

En cas de taches incrustées et difficiles à éliminer avec le nettoyage ordinaire, utiliser un détergent plus concentré et le laisser agir le temps nécessaire et, ensuite, frotter plus ou moins intensément jusqu'à ce que les carreaux retrouvent leur aspect original.

À ce propos, il faut signaler que le grès cérame est résistant à toute substance chimique, à l'exception de l'acide fluorhydrique qui attaque toutes les produits céramiques et qui, par conséquent, ne doit jamais être utilisé.

Pour le nettoyage des sols des zones publiques, il est conseillé d'intervenir après la fermeture des locaux afin que le sol soit bien sec à l'ouverture.

Autrement, il est conseillé d'isoler le sol jusqu'à ce qu'il soit complètement sec.

Pour les locaux d'une superficie plus importante, il convient de disposer d'auto-laveuses afin d'assurer un nettoyage parfait ainsi qu'une bonne hygiène.

Le sol doit être considéré comme propre lorsqu'il retrouve son aspect original.

Surfaces antidérapantes

Pour les carreaux antidérapants, utilisés généralement dans les pièces humides, il faut prendre en compte les problèmes spécifiques de nettoyage dus aux surfaces rugueuses, structurées ou en relief : elles demandent une plus grande attention.

Pour nettoyer ces surfaces, les auto-laveuses à brosses contre-rotatives, où la variation du sens de rotation permet aux poils de toujours rester perpendiculaires au sol de façon à atteindre les éventuels creux de la surface, ou les auto-laveuses à rouleau sont particulièrement optimales.

Il ne faut en aucun cas utiliser des tampons abrasifs qui pourraient abraser la surface des carreaux et donc en réduire les propriétés antidérapantes originelles.

Pour les sols de plus grandes dimensions, il est conseillé d'utiliser des machines pourvues de dispositifs pouvant aspirer les liquides et les saletés, qui seront canalisés dans un réceptacle prévu à cet effet.

Le nettoyeur à haute-pression peut également être utilisé pour ce type de sol. Toutefois, il faut que la pression soit modérée sur les joints, et particulièrement ceux réalisés avec des produits à base de ciment.

Pflege und Reinigung

Nach der Verlegung sind Böden und Wände aus Keramik immer zu schützen und es ist unbedingt zu vermeiden, mit Schuhen Keramikflächen zu betreten, die ausschließlich als Barfußbereiche konzipiert sind.

Je nach der Größe der zu behandelnden Oberfläche kann die Instandhaltung mechanisch oder manuell erfolgen.

Die Instandhaltung der Fliesen für Schwimmbäder aus unglasiertem Feinsteinzeug Granitogres und aus glasiertem Feinsteinzeug Gresplus verlangen normalerweise keine besondere Pflege, sondern nur die Befolgung der folgenden Reinigungsvorschriften.

Erstreinigung

Die Erstreinigung erfolgt normalerweise nur einmal nach der Verlegung der Keramikplatten und vor Beginn der Verwendung des Bodenbelags/der Wandverkleidung, da sie vorrangig dazu dient, alle Spuren von Zement, Kleber und/oder Fugenmörtel nach der Verlegung und der Versiegelung der Fugen zu entfernen.

Nachdem Rückstände und größere Verunreinigungen auf dem Bodenbelag entfernt wurden, gehen Sie folgendermaßen vor:

- 1) Die Oberfläche mit Wasser befeuchten, um die Fugen zu imprägnieren und somit vor der ätzenden Wirkung des säurehaltigen Reinigungsmittels (Kalklöser) zu schützen.
- 2) Das Reinigungsprodukt (siehe Anmerkung A) in der vom Hersteller vorgegebenen Konzentration (Mischverhältnis mit Wasser) mit einer Handbürste oder einer motorbetriebenen Bürste auftragen, wobei der Kontakt mit etwaigen angrenzenden Stahl-, Aluminium- und Marmorkomponenten vermieden werden sollte.
- 3) Während der Wirkzeit, die je nach Zustand des

Fußbodens festzulegen ist, den hartnäckigsten Schmutz abreiben und etwaige Mörtel und Kitt Rückstände usw. abkratzen.

- 4) Den Fußboden/die Wandverkleidung schließlich mit sauberem Wasser abspülen und das Schmutzwasser sofort von Hand oder mit einer Bodenreinigungsmaschine aufnehmen.

Wenn die Erstreinigung erst nach der Benutzung des Fußbodens/der Wandverkleidung erfolgt, müssen vor der Anwendung des säurehaltigen Reinigungsmittels etwaige Fette oder ähnliche Stoffe mit geeigneten Alkalireinigern (Fettlösern) entfernt werden (siehe Absatz „Normale Reinigung“).

Falls erforderlich, kann die Erstreinigung wiederholt werden.

Infolge der Erstreinigung von Keramikprodukten mit geschliffener (Levigata), geläppter (Lappata) oder glänzender (Lucida) Oberfläche mit säurehaltigen Mitteln kann ein leichter Glanzverlust auftreten, der als normal betrachtet werden muss, da er auf die Entfernung von Rückständen der für die Oberflächenbearbeitung verwendeten Schleifmittel zurückzuführen ist.

Der Einsatz von Reinigungsmitteln auf Phosphorsäurebasis ist gegenüber solchen auf Salzsäurebasis vorzuziehen, da diese auf Metalle weniger aggressiv wirken.

- A) Einige empfohlene Reinigungsmittel zur Entfernung von Mörtelresten:

Verfugung mit Zementfugenmörtel – säurehaltige Reinigungsmittel (Kalklöser)

Deterprimo Plus (Casalgrande Padana), Deterdek (Fila), Keranet (Mapei), Deltaplus (Kerakoll), Solvacid (Geal) oder ähnliche Mittel (die Angaben des Reinigungsmittelherstellers beachten).

Verfugung mit Epoxidfugenmörtel – alkalische Reinigungsmittel

Fuga-Soap Eco (Kerakoll), Kerapoxy Cleaner (Mapei), Tile Cleaner (Faber), CR10 (Fila), Lithofin Resin-Ex (Lithofin), Eposolv (Geal) oder ähnliche Mittel (die Angaben des Reinigungsmittelherstellers beachten).

Normale Reinigung

Für die Alltagsreinigung genügt es, den Fußboden/die Wandverkleidung mit Wasser und normalen Reinigungsmitteln für Keramikflächen zu reinigen (für Wandverkleidungen Gelreiniger verwenden).

Da die Oberflächen der Produkte von Casalgrande Padana praktisch nicht aufnahmefähig sind, müssen für ihren Schutz keine Wachse und/oder silikonhaltige Produkte aufgetragen werden. Ganz im Gegenteil sollten diese niemals verwendet werden, da sie einen Oberflächenfilm bilden können, der die natürlichen Eigenschaften des Feinsteinzeugs verändert.

Bei beständigen und schwer entfernbaren Flecken, die sich nicht mit einer normalen Reinigung beseitigen lassen, können konzentriertere Reinigungsmittel verwendet werden; diese sollte man für eine angemessene Zeit einwirken lassen und dann angemessen kräftig abreiben, bis die Platten wieder ihr ursprüngliches Aussehen zurückerhalten.

Wir weisen darauf hin, dass Feinsteinzeug gegen alle chemischen Mittel beständig ist, mit Ausnahme von Fluorwasserstoffsäure, die alle Keramikprodukte angreift und daher niemals verwendet werden darf.

In öffentlichen Bereichen sollte die Reinigung nach der Schließzeit vorgenommen werden, damit der Boden bei der Wiedereröffnung trocken ist; anderenfalls sollte der gereinigte Bereich bis zur kompletten

Trocknung abgesperrt werden.

Für große Räumlichkeiten ist der Einsatz von Reinigungsmaschinen empfehlenswert, um eine perfekte Reinigung und Hygiene sicherzustellen. Der Bodenbelag gilt als sauber, wenn er sein ursprüngliches Aussehen wieder angenommen hat.

Rutschfeste Oberflächen

Bei Fliesen mit rutschfester Oberfläche, die in der Regel in feuchten oder nassen Umgebungen verwendet werden, müssen die spezifischen Reinigungsprobleme berücksichtigt werden, die mit der rauen, strukturierten oder reliefierten Oberflächenstruktur zusammenhängen und daher eine besondere Aufmerksamkeit erfordern.

Für die Reinigung dieser Art von Oberflächen haben sich gegenläufig rotierende Bürstmaschinen oder Walzenmaschinen als vorteilhaft erwiesen, bei denen durch den Wechsel der Drehrichtung die Borsten immer senkrecht zum Bodenbelag stehen, um etwaige Oberflächeneinkerbungen erreichen zu können.

Auf keinen Fall sollten Scheuerschwämme verwendet werden, die die Keramikoberfläche abtragen und damit die originale Rutschfestigkeit verringern könnten.

Für größere Bodenflächen empfehlen wir die Verwendung von Maschinen mit Vorrichtungen zum Aufsaugen der Flüssigkeiten und mit diesen des Schmutzes, die dann in einem entsprechenden Behälter gesammelt werden.

Ein weiteres Hilfsmittel zum Reinigen dieser Art von Bodenbelägen ist der Dampfstrahler, allerdings sollte dieser nur mit mäßigem Druck bei Fugen eingesetzt werden, vor allem wenn diese mit Fugenmörtel auf Zementbasis gefertigt wurden.

manutenzione e pulizia / maintenance and cleaning / entretien et nettoyage / pflege und reinigung

TIPO DI SPORCO TYPE OF DIRT TYPE DE SALETE ART DES SCHMUTZES				CATEGORIA DETERGENTE TYPE OF DETERGENT CATEGORIE DETERGENT KATEGORIE DES REINIGUNGSMITTELS	ALCUNI PRODOTTI SUGGERITI SOME RECOMMENDED PRODUCTS QUELQUES PRODUITS SUGGERES EINIGE PRODUKTEMPFEHLUNGEN	
Sangue Oli e grassi animali e vegetali Matita, pennarello e inchiostro Striature di scarpe Caffè, Coca cola e vino rosso Olio motore e pneumatici d'auto	Blood	Sang	Blut	Alcalino Alkaline Alcalin Alkalireiniger	Candeggina	
	Animal and vegetal oils and greases	Huiles et graisses animales et végétales	Tierische und pflanzliche Öle und Fette		Cif	Unilever
	Pencil, felt-tip pens and ink	Crayon, feutre et encre	Bleistift, Filzstift und Tinte		Ajax	Colgate Palmolive
	Scuff marks	Rayures de chaussures	Schuhschlieren		Mastro Lindo	Procter & Gamble
	Coffee, coke and red wine	Café, Coca et vin rouge	Kaffee, Coca Cola und Rotwein		PS 87	Fila
Engine oil and car tyres	Huile moteur et pneus de voiture	Motoröl und Autoreifen		Radiant	Zep	
					Coloured Style Remover	Faber
					Chittone	Madras
					Grundreiniger	Patina Fala
Residui cementizi Residui boiacche colorate Ruggine Depositi calcarei	Cement residues	Résidus de ciment	Zementrückstände	Acido Acidic Acide Reiniger auf Säurebasis	Deterprimo	Casalgrande Padana
	Coloured grout residues	Résidus de mastic coloré	Rückstände von dünnflüssigem Zement		Deterdek	Fila
	Rust	Rouille	Rost		Keranet	Mapei
	Scaling	Dépôts de calcaire	Kalkstein		Deltaplus	Kerakoll
					Terfox	Zep
					Viakal	Procter & Gamble
					Cement Remover	Faber
					Kuku	Lithofin
					Acid-Tech	Patina Fala
					Ras Klinker	Madras
			Nordecalforte	Nord Resine		
Resine Vernici Silicone Nicotina Catrame	Resin	Résines	Harz	Solvente Solvent Solvant Lösungsmittel	Filasolv	Fila
	Paint	Peintures	Lack		F-Ch	Madras
	Silicone	Silicone	Silikon		Solvent Stripper	Faber
	Nicotine	Nicotine	Nikotin		Neutrex	General
	Tar	Goudron	Teer			

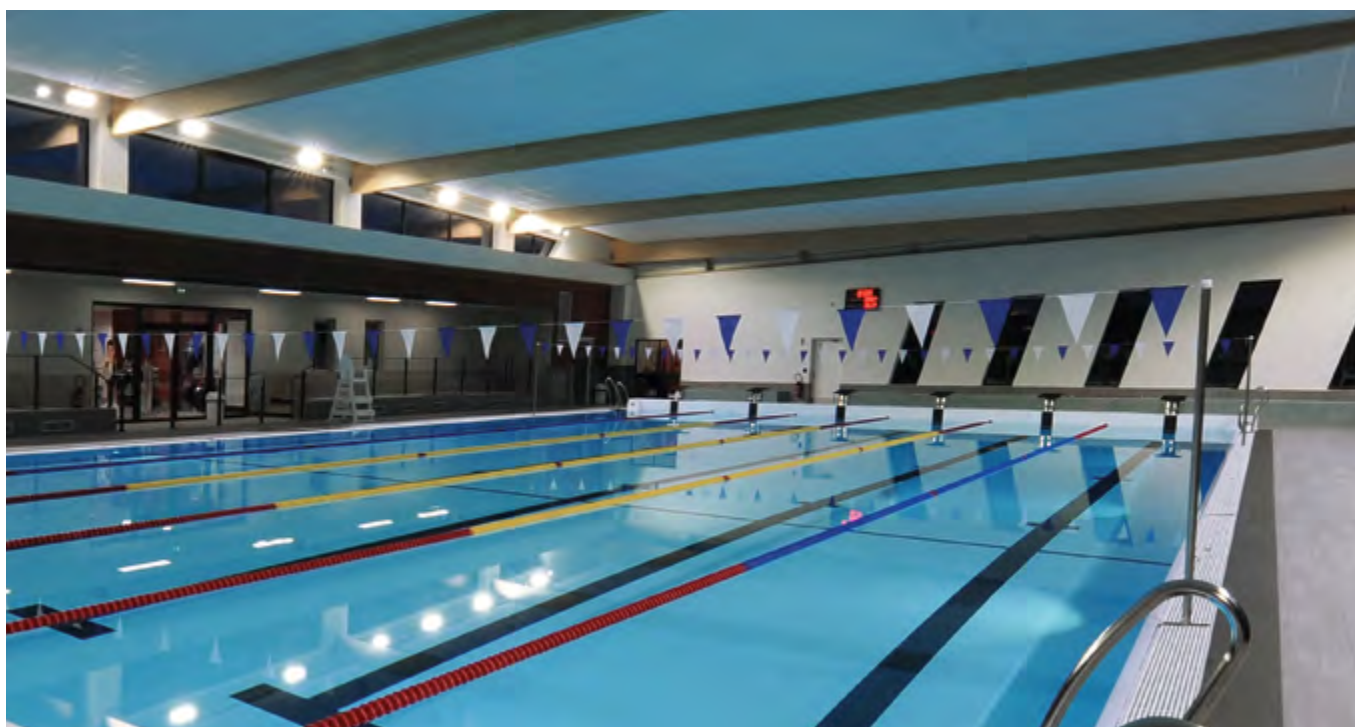



© Copyright Casalgrande Padana
Aprile 2023

Casalgrande Padana si riserva di modificare in qualunque momento e senza preavviso le informazioni e le caratteristiche tecniche contenute nel presente catalogo. I colori e l'estetica dei prodotti sono quanto più possibile vicini a quelli reali, nei limiti consentiti dai processi di stampa.

Casalgrande Padana reserves the right, at any moment and without prior notice, to change the information and technical characteristics given in this catalogue. Within the limits of printed material, the colours and aesthetic features of the products illustrated correspond as closely as possible to those of the actual products.

Questo catalogo è stampato su carta certificata FSC®.
This catalog is printed on FSC® certified paper.

Questo catalogo è stampato su carta certificata FSC®.
This catalog is printed on FSC® certified paper.

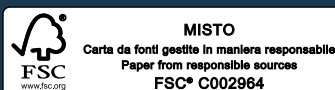



CASALGRANDE
PADANA
THE GREEN WAY TO PAVE

Casalgrande Padana s.p.a.
Swimming Pool

Via Statale 467, n°73 - 42013 Casalgrande (RE) - Italia
Tel +39 0522 990801 - Fax +39 0522 771668
pool@casalgrandepadana.it
www.padanapiscine.com

